

Pl. 1. Carte des sites évoqués.



Pl. 2. Carte de répartition des sites.



Pl. 3. Emplacement des entités politiques évoquées occupant le plateau au VIIIe siècle.

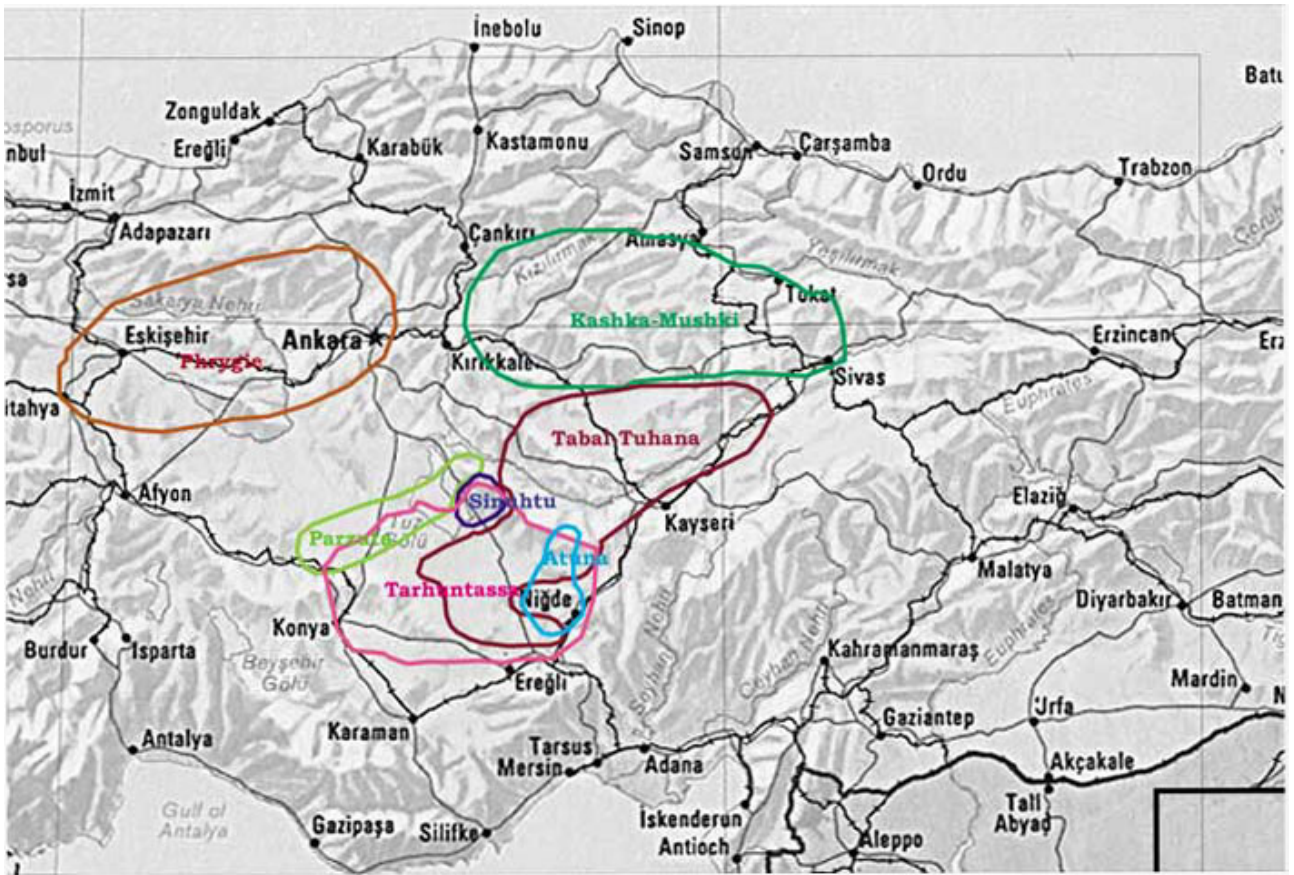

Pl. 4. Découpage administratif actuel¹.

¹DEWDNEY, 1971, Fig. 1.

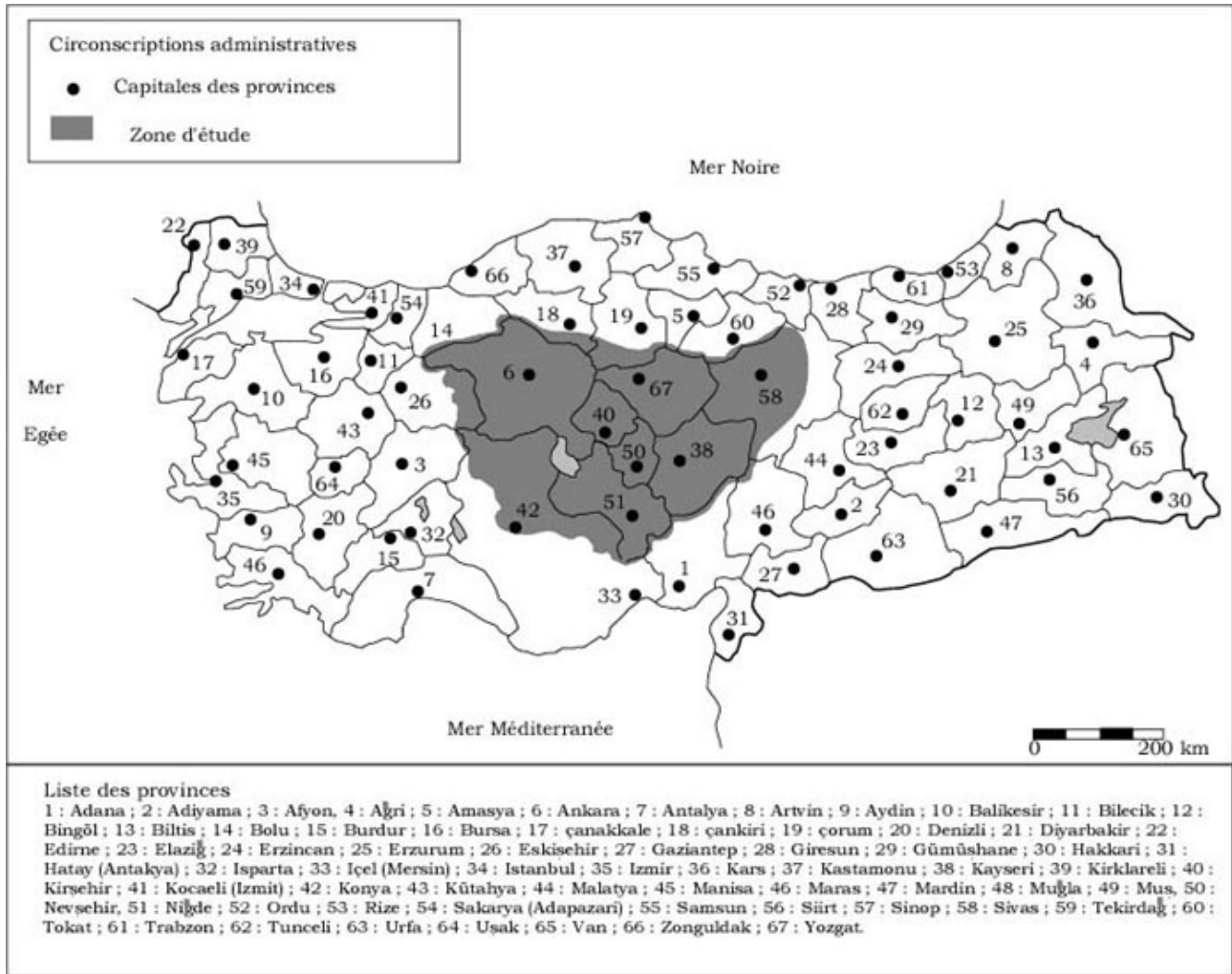

Pl. 5. Répartition des précipitations moyennes annuelles en Turquie².

²KUZUCUOĞLU, ROBERTS, 1998, fig. 1.

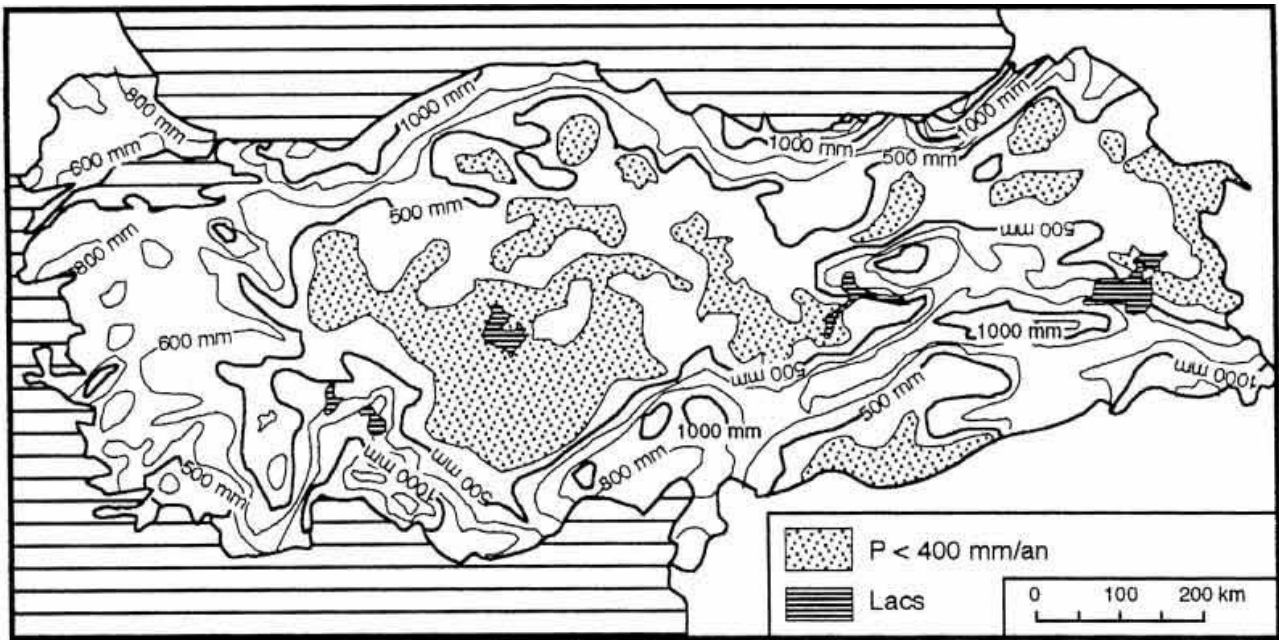

Pl. 6. Régions phytogéographiques de l'Anatolie³.

³KUZUCUOĞLU, 1998, Fig. 2.

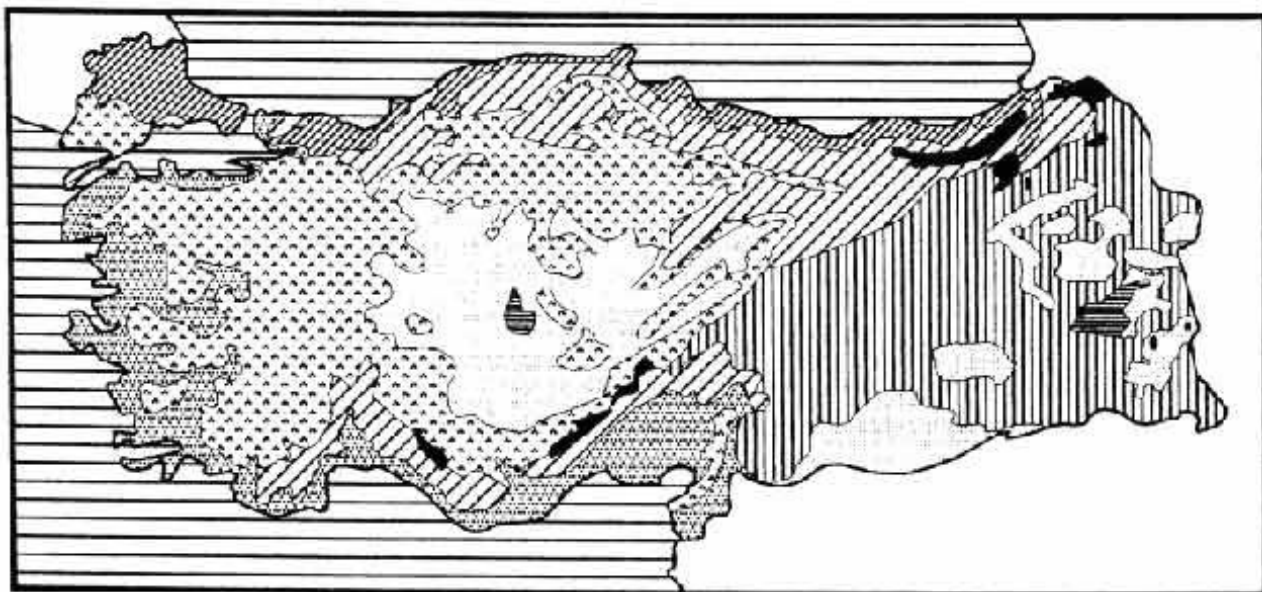

- 1 : Végétation méditerranéenne
- 2 : Forêts mixtes feuillus/ résineux résistants au froid
- 3 : Forêts denses d'altitude
- 4 : Forêts denses de feuillus adaptés au froid
- 5 : Forêts d'altitude de feuillus caducifoliés adaptés au froid
- 6 : Steppe
- 7 : Végétation alpine et sub-alpine
- 8 : Lacs

Pl. 7. Répartition des régions naturelles⁴.

⁴FISCHER, 1950, 293, fig. 47.

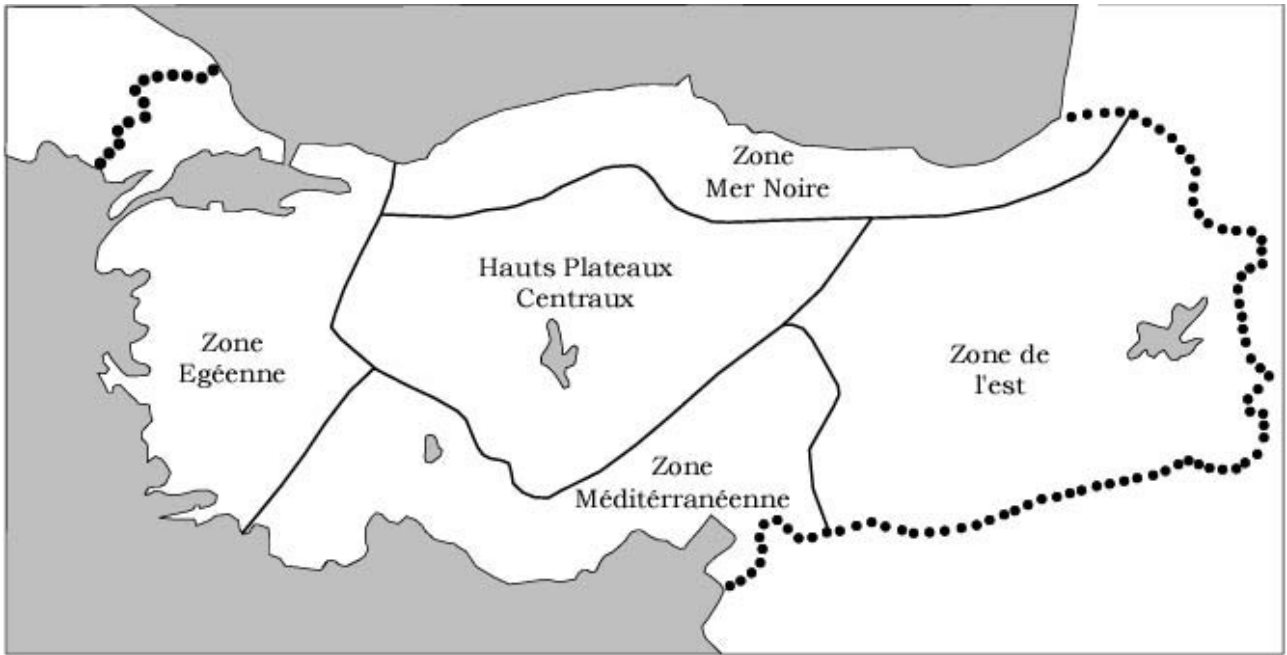

Pl. 8. Distribution des minéraux en Turquie⁵.

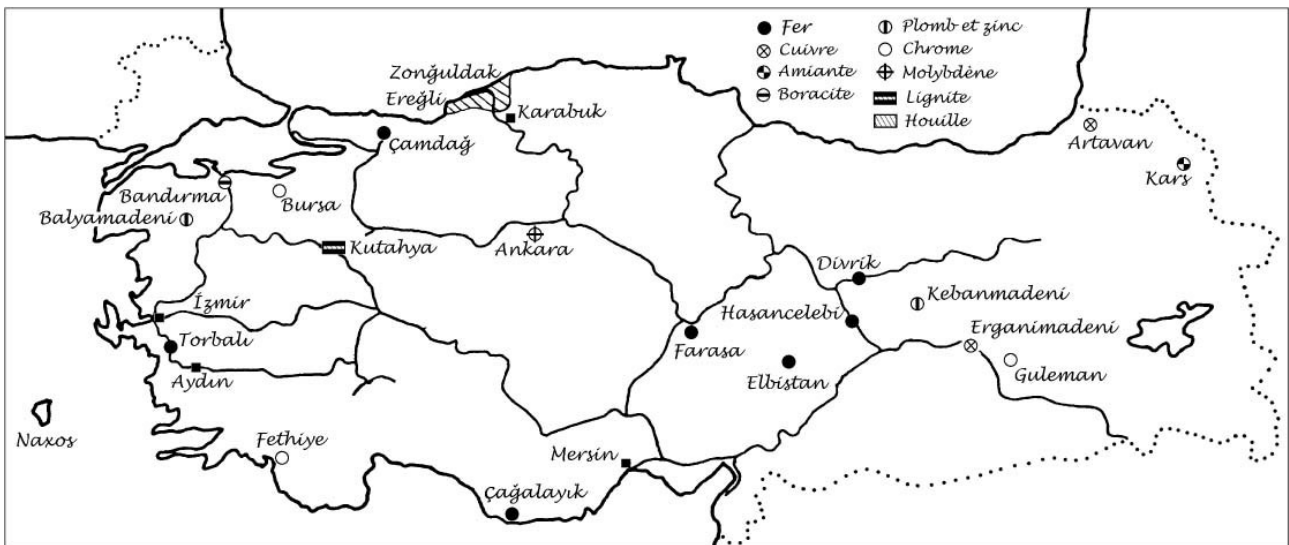

Pl. 9. Carte des entités politiques au premier millénaire
Carte de répartition selon Körte⁶.

⁵FISCHER, 1950, 325, fig. 54.

⁶KÖRTE, 1904, 5.

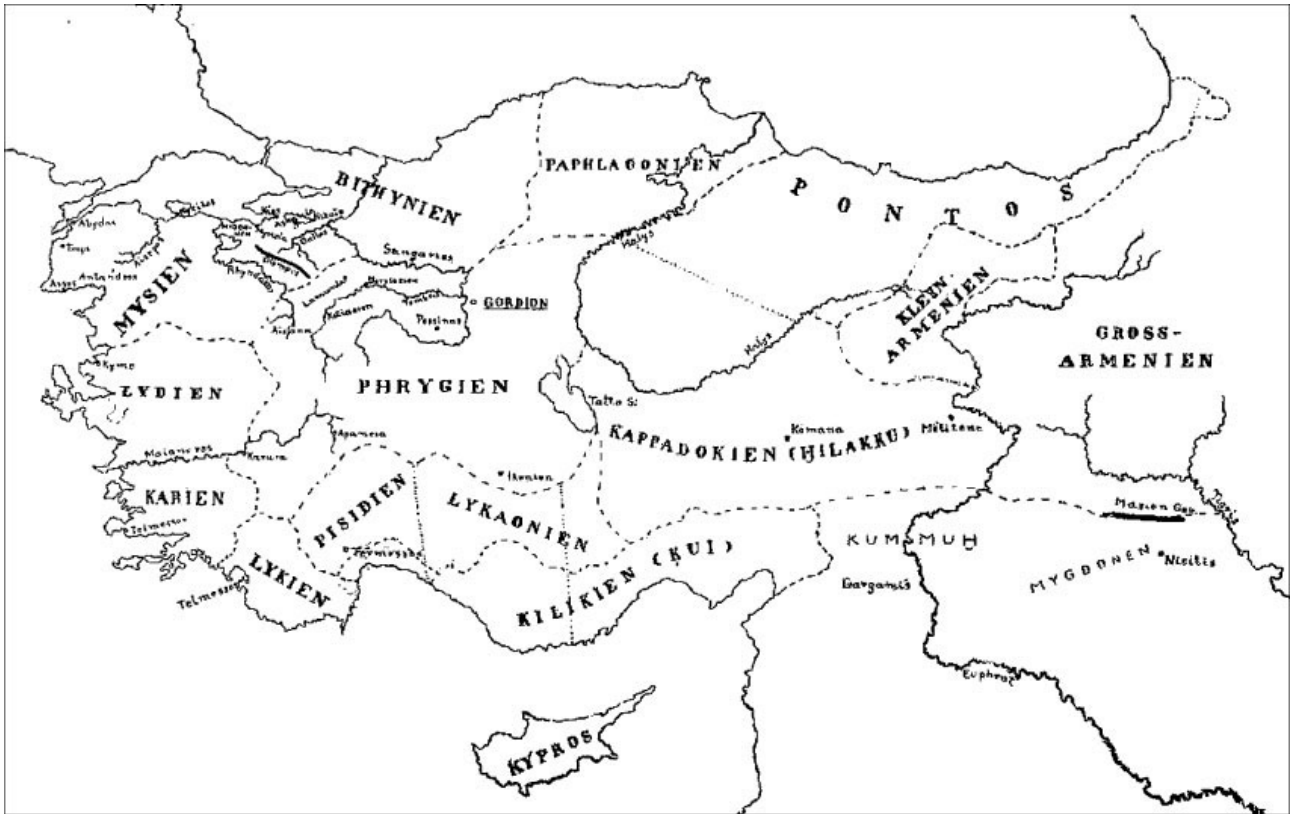

Pl. 10. Plan, Gâvurkalesi⁷.

⁷von der OSTEN, 1937, fig. 56.

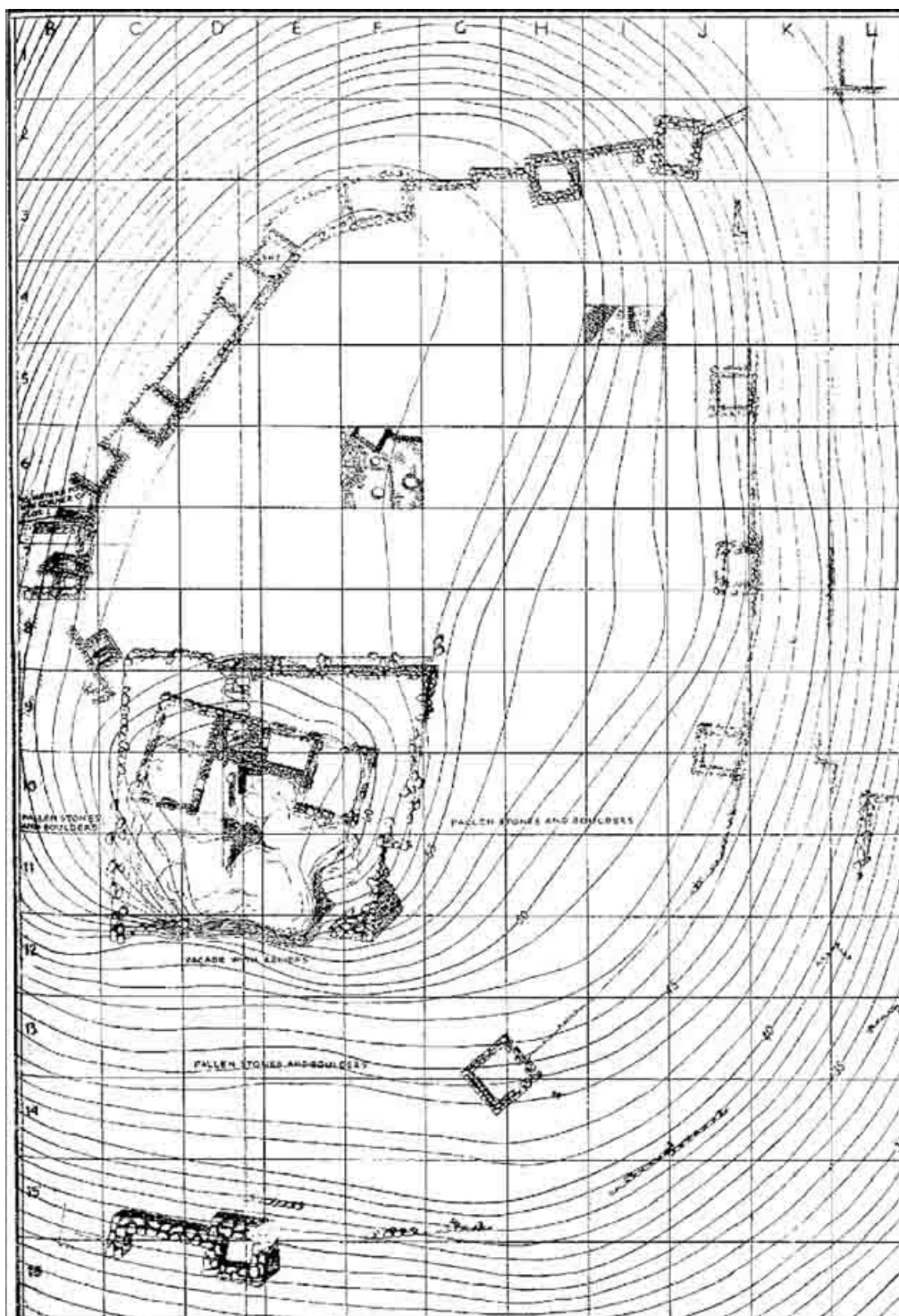

Pl. 11. Acropole de la cité de Midas⁸.

⁸GABRIEL, 1952, 23-23, fig. 3.

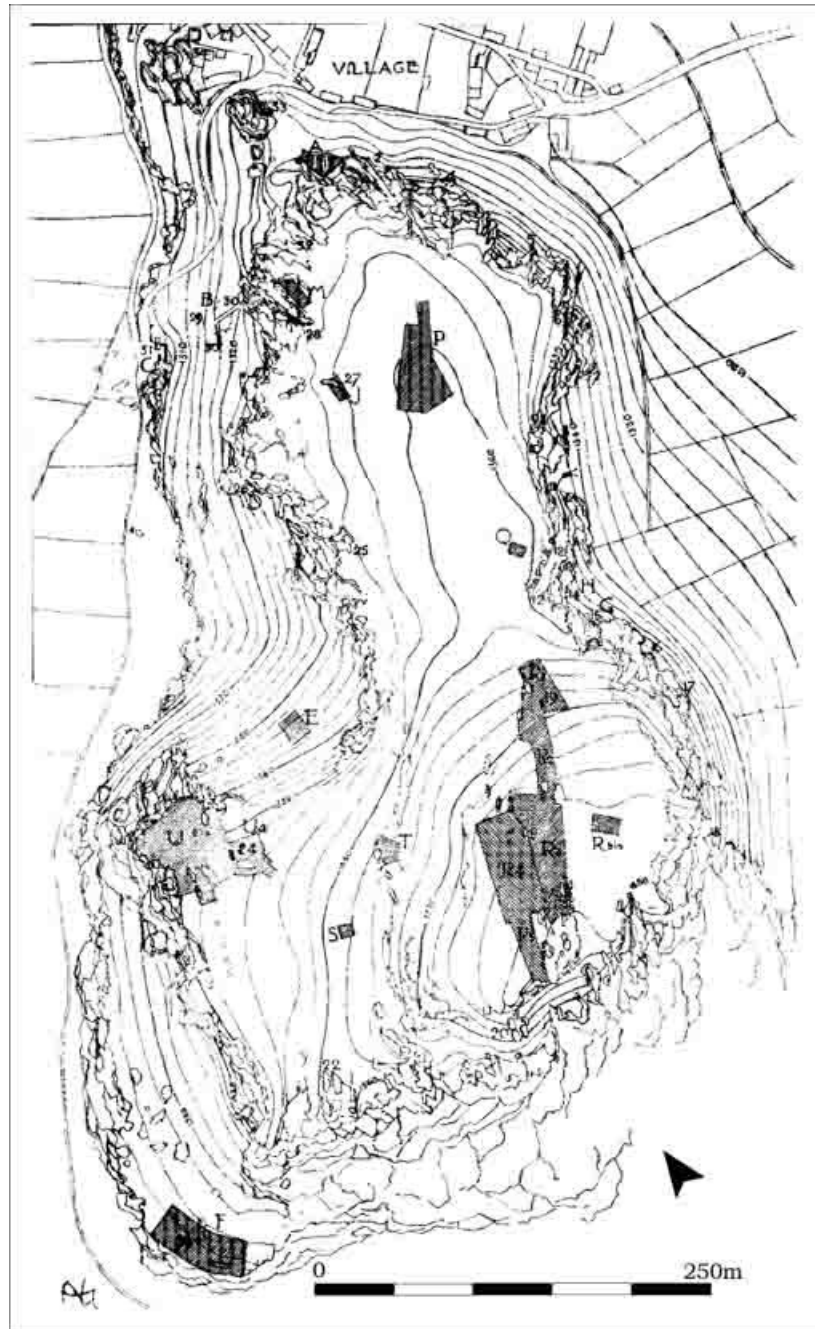

Pl. 12. Hypothèse de répartition des royaumes centraux anatoliens et d'extension territoriale des entités politiques⁹.

⁹D'après BITTEL, 1970.



Pl. 13. Emplacement de Tabal par rapport aux autres entités politiques de l'époque¹⁰.

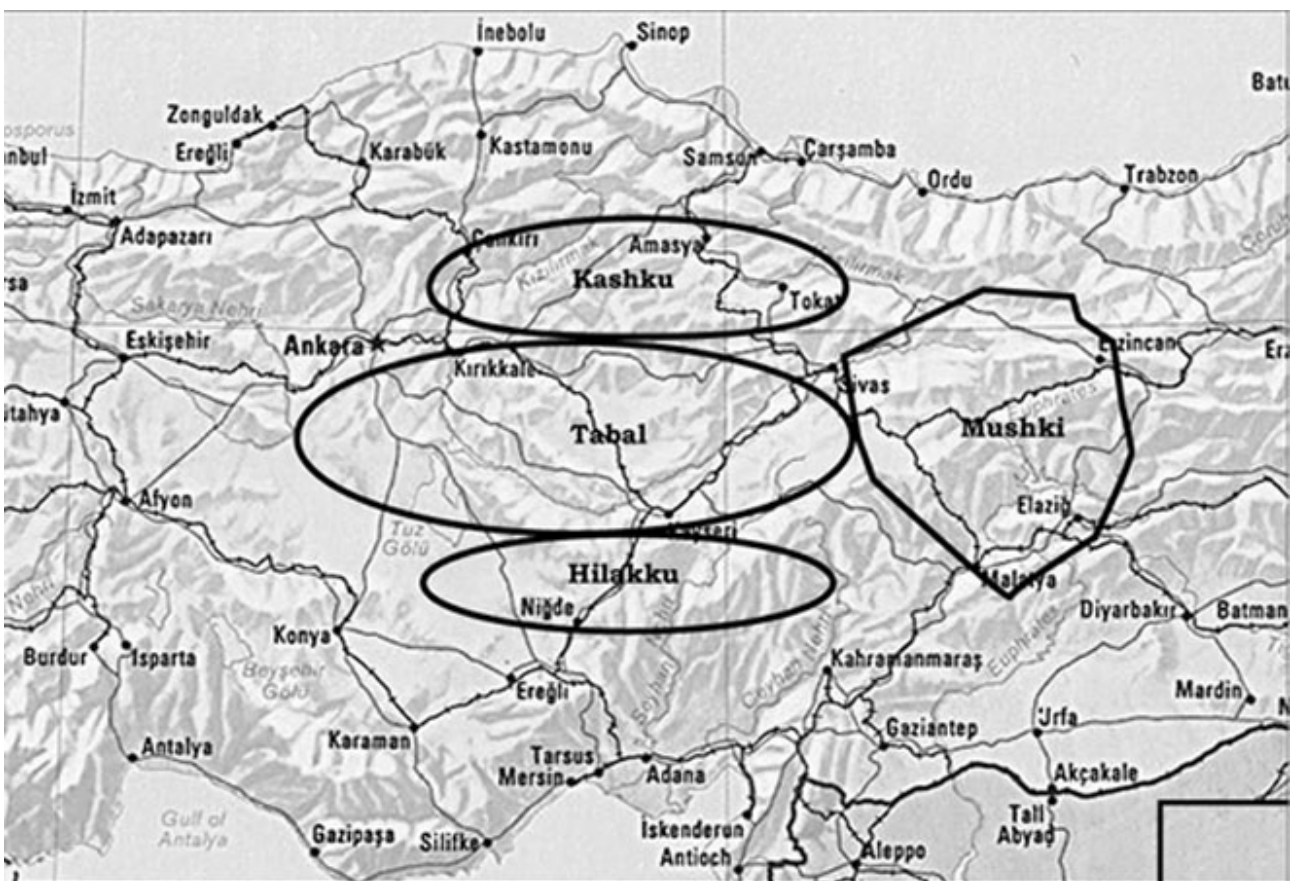

Pl. 14. Implantation des nouveaux sondages à Gordion¹¹.

¹⁰WÄFLER, 1983, 181-193.

¹¹HENRICKSON, VOIGT, 1998, 81, Fig. 2.

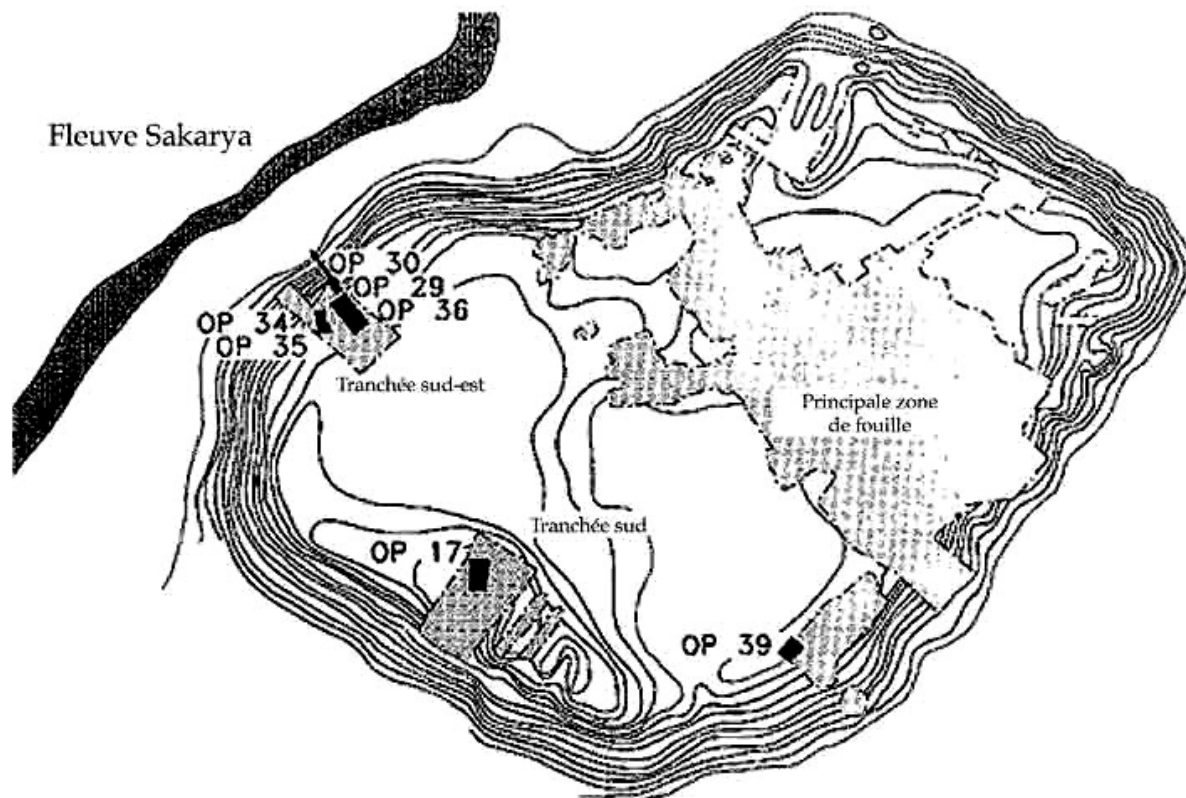

YASSIHÖYÜK/GORDION 1995

▨ Zones fouillées entre 1900 et 1995

■ Zones fouillées en 1995



Pl. 15. Tableau des mentions des Peuples de la Mer dans les textes égyptiens, par les différents pharaons¹².

¹²Extrait de MERTENS, 1960, 72.

PEUPLES SOUVERAINS	Loukou	Toursha	Shakalesh	Shardanes	Akaouash	Ouashash	Péléset	Thekker	Danouna	Mashaouash	Dardhy, etc.
	Aménophis IV Lettres el-Amarna (env. 1365)	■									
Ramsès II a) Vers 1297				■							
b) Kadesh (1294/3) du côté hittite	■										■
du côté égyptien				■							
Mineptah Bataille de Per-ir (1230)	■	■	■	■	■					■	
Ramsès III a) Médinet Habou an 5 (1194)							?	?		■	
an 8 (1191)			■			■	■	■	■		
du côté égyptien an 11 (1188)				■						■	
pavillon		■		■		■	■	■			
b) Papyrus Harris				■		■	■	■	■	■	
Ramsès XI Ounamon (1090)								■			

Pl. 16. Carte de répartition des inscriptions louvites¹³.

¹³PRAYON, 1994, Karte 18.

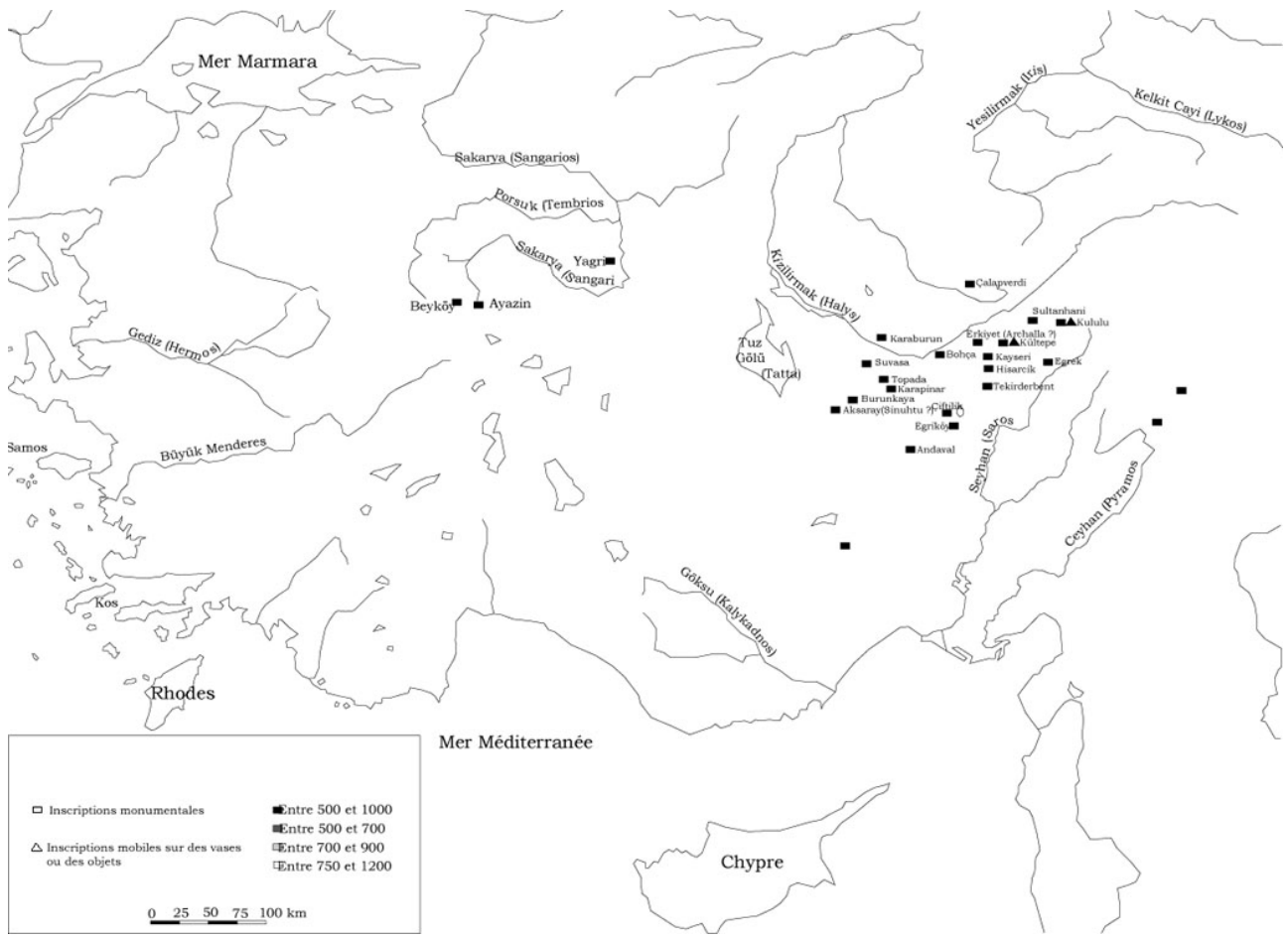

Pl. 17. Relief de Kızıldağ¹⁴.



Pl. 18. Chronologie des rois de Carchémish¹⁵.

¹⁴Extrait de BITTEL, 1976, 239.

¹⁵HAWKINS, 1988, 107.

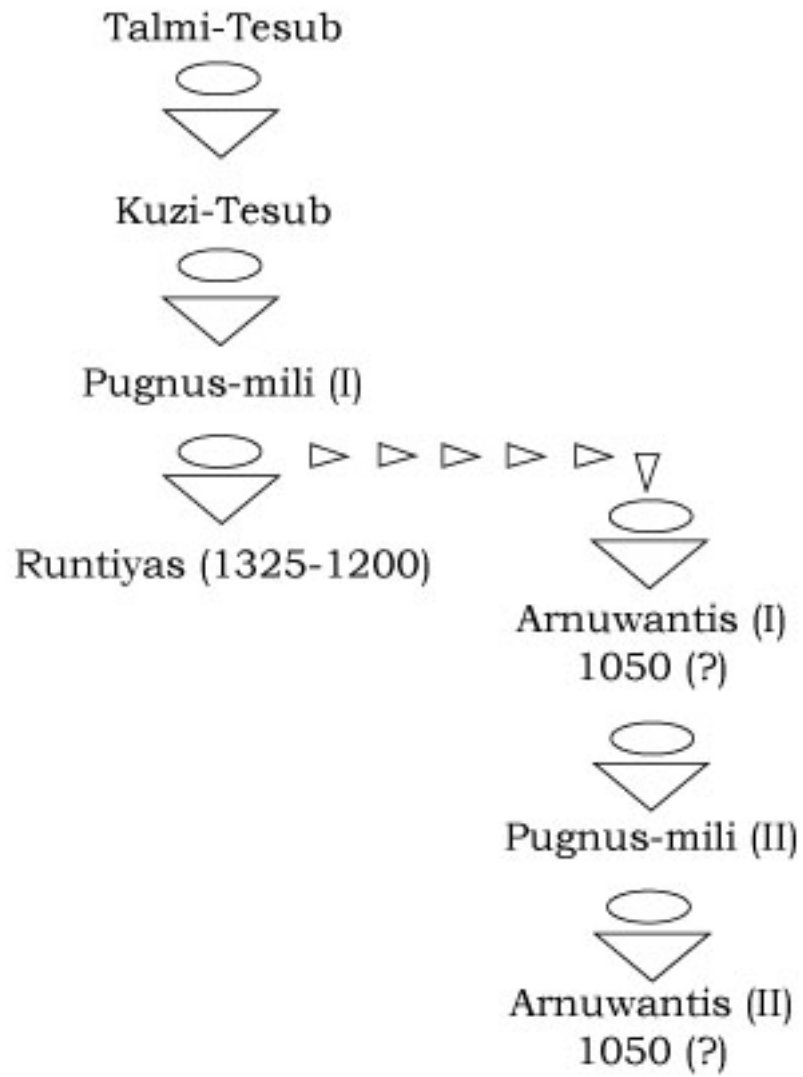

Pl. 19. Carte de répartition des inscriptions phrygiennes¹⁶.

¹⁶PRAYON, 1994, Karte 15.

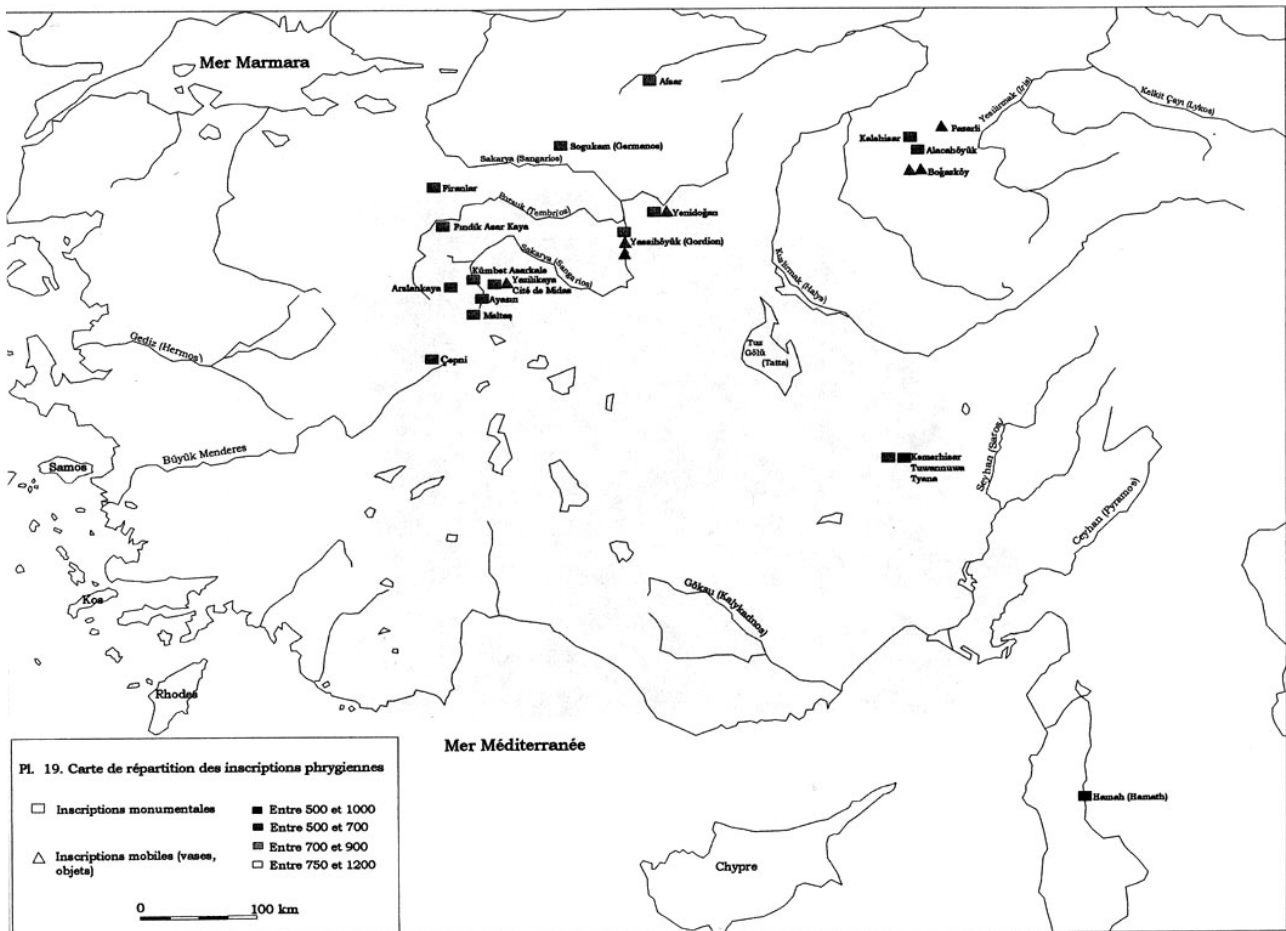

Pl. 20. Façade sculptée dite du "tombeau de Midas", ville de Midas¹⁷.



¹⁷Extrait de BRIXHE, LEJEUNE, 1984, pl. I.

Pl. 21. G-105, bol en bronze inscrit, Gordion¹⁸.



Pl. 22. Lion inscrit¹⁹.



Pl. 23. Fragment de stèle en basalte de Kemerhisar²⁰.

¹⁸Extrait de BRIXHE, LEJEUNE, 1984, pl. LII.

¹⁹Extrait de BRIXHE, LEJEUNE, 1984, CXXII. P-05.

²⁰Extraite de BRIXHE, LEJEUNE, 1984, T-03.



Pl. 24. Tableau de concordance.

ASSYRIE	TABAL	TUHANA	ATUNA	ISTUNDI	HUBISNA	SINUHTU	URARTU
Salmanazar III 858-824	Tuatti						
	Kikki						
	Tuwati(a)		Masaur-hisas				Argisti
Tiglat-Pileser III 744-727	Uassurme/ Wasu-sar(ru)ma 738-730	Urbal'a/ Warpalawas 738-710	Ushitti 738-732	Tuhamme 738-732	Uirime 738-732		
	Hulli 730-?						
Sargon II 721-705			Kurti 718-713			Kiakki 718	
	Ambaris ?-713		? 710	? 710			
	Ahat-abisa, Nabu-tec		Matti				

Pl. 25. Carte avec les hypothèses d'occupation territoriale²¹.



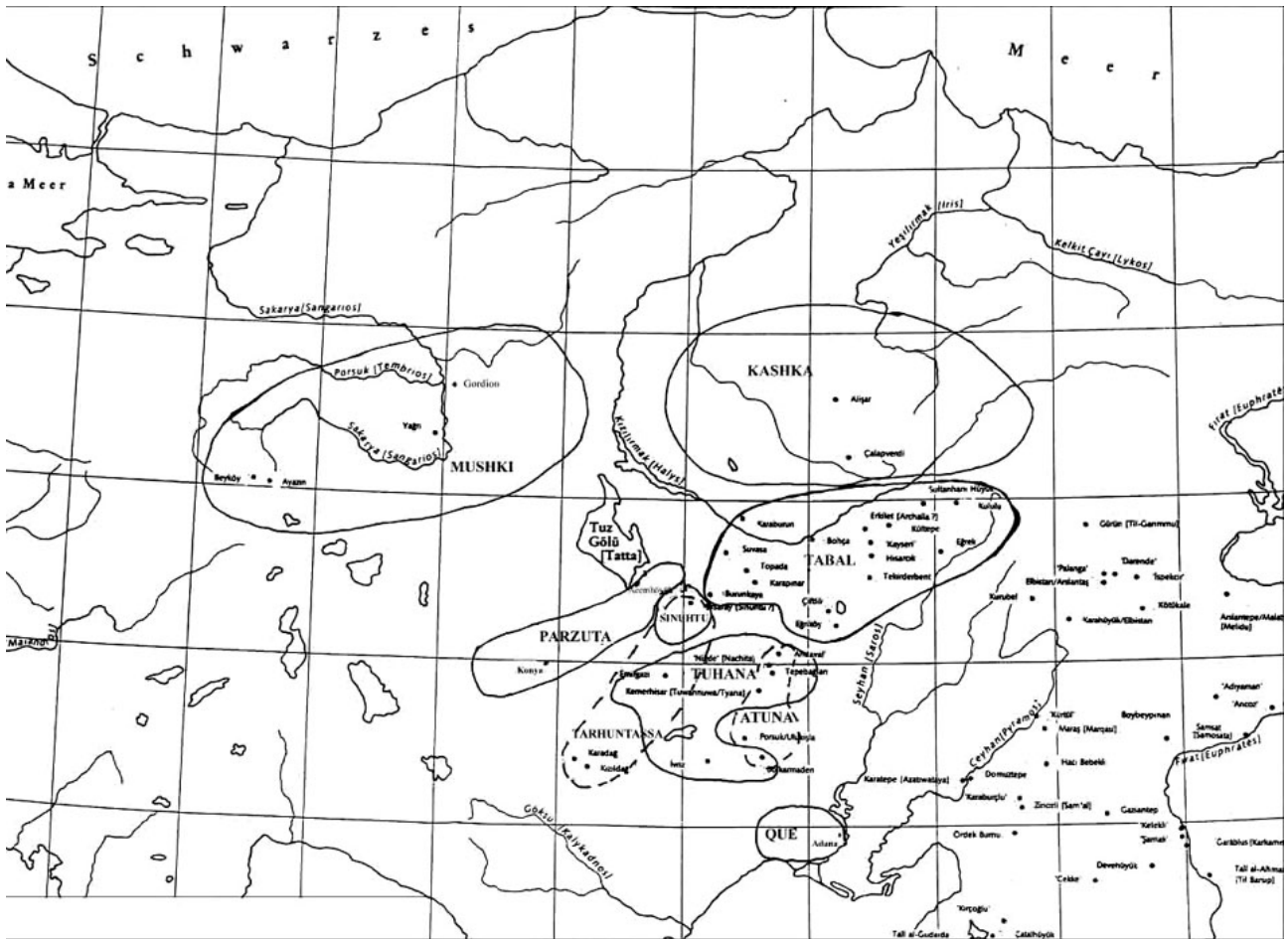









²¹D'après PRAYON, 1994, Karte 15.



Pl. 26. Structure CKD/CK, Gordion²².

²²VOIGT, 1994, 284, fig. 25. 2. 2.

YASSIHÖYÜK/GORDION

	Mur		Boue pour la construction		Pierre
	Trou de poteau		Argile brûlée		Fosse contemporaine
	DØnivelØe		Dépotoir		Fosse intrusive
	Pierres pour la construction		Dépression		Débris d'occupation
					Remplissage d'argile

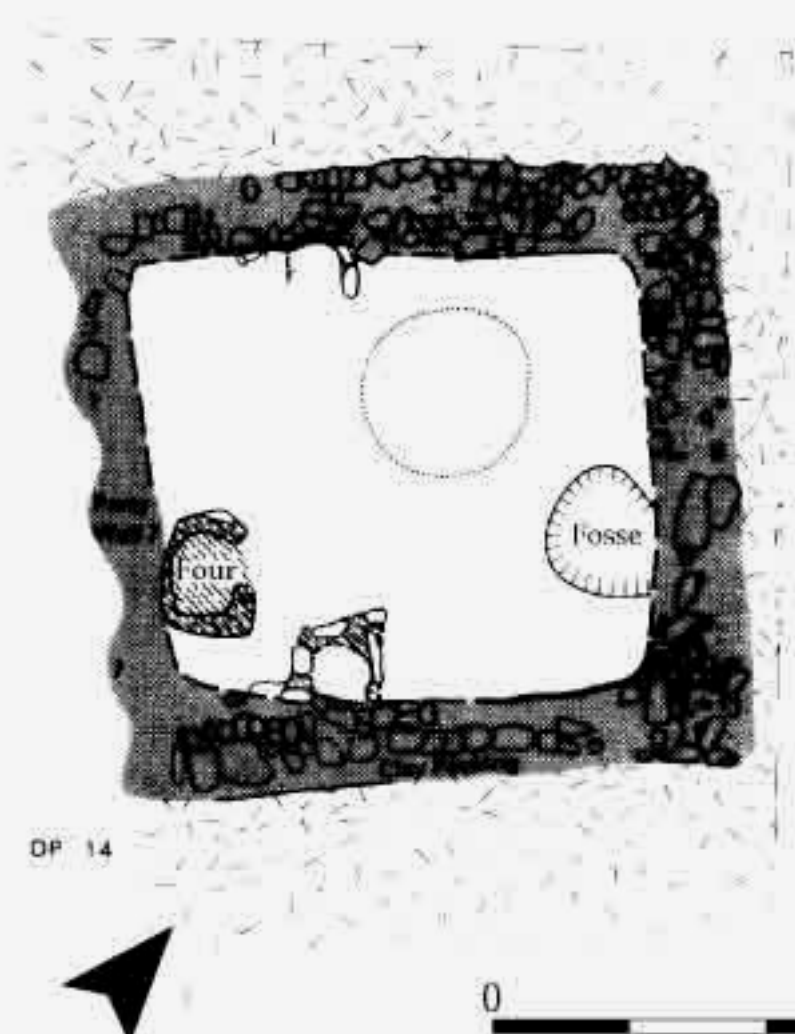

DP 14

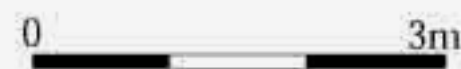

Pl. 27. La structure SSH/SHS, Gordion²³.



Pl. 28. La structure BRH/GBR, Gordion²⁴.

²³VOIGT, 1994, 288, Pl. 25.2.4. ; 289, Pl. 25. 3.1.

²⁴VOIGT, 1994, 285, Fig. 25. 3.1.

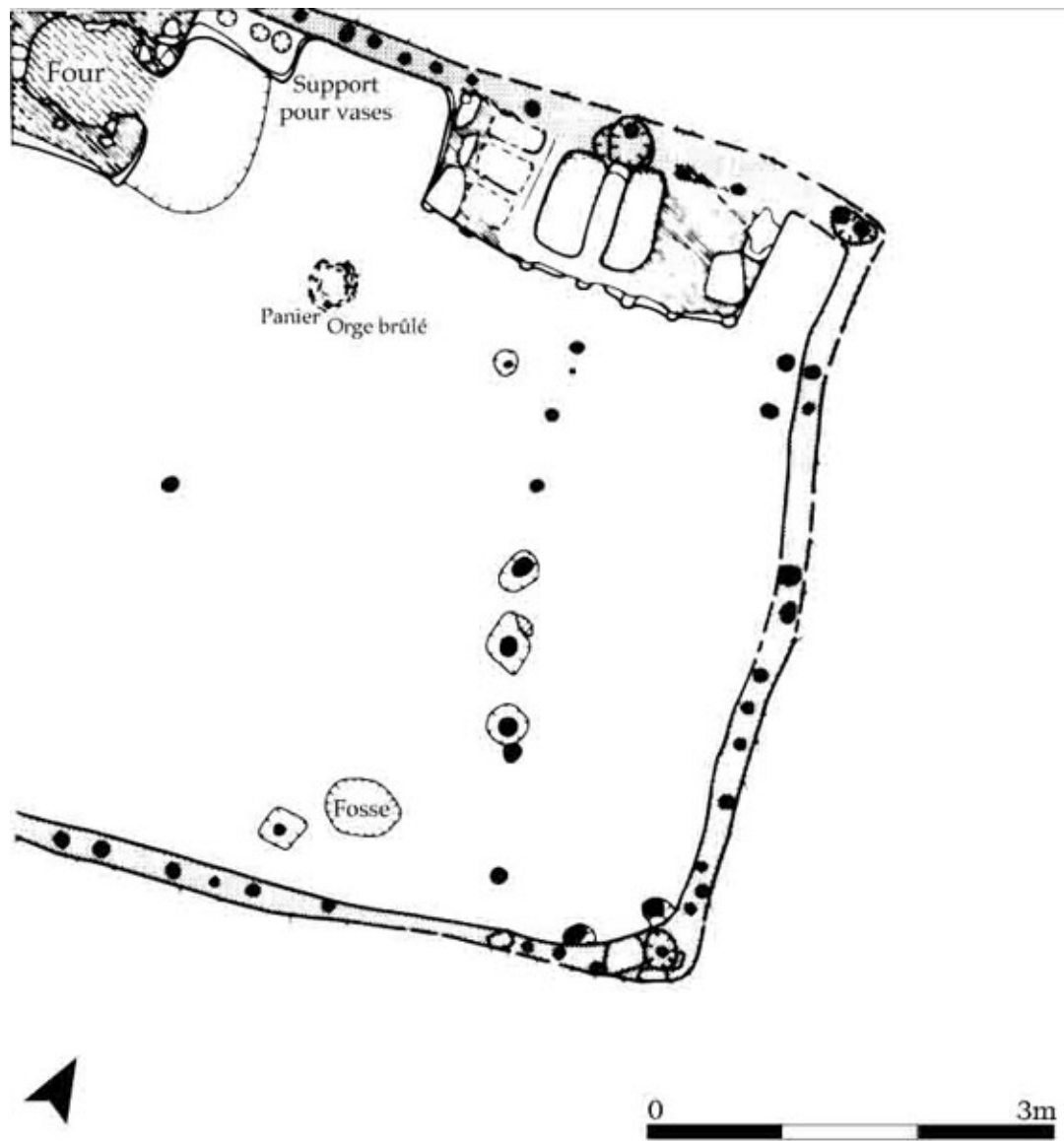

Pl. 29. Détail du four et des éléments âpretés de la structure BRH/GBR²⁵.

²⁵VOIGT, 1994, 289, Pl. 25. 3. 4. ; 290, Pl. 25.4. 2.



Pl. 30. Plan schématique de la phase récente, Büyükkaya²⁶.

²⁶SEEHER, 1996, Abb. 17.

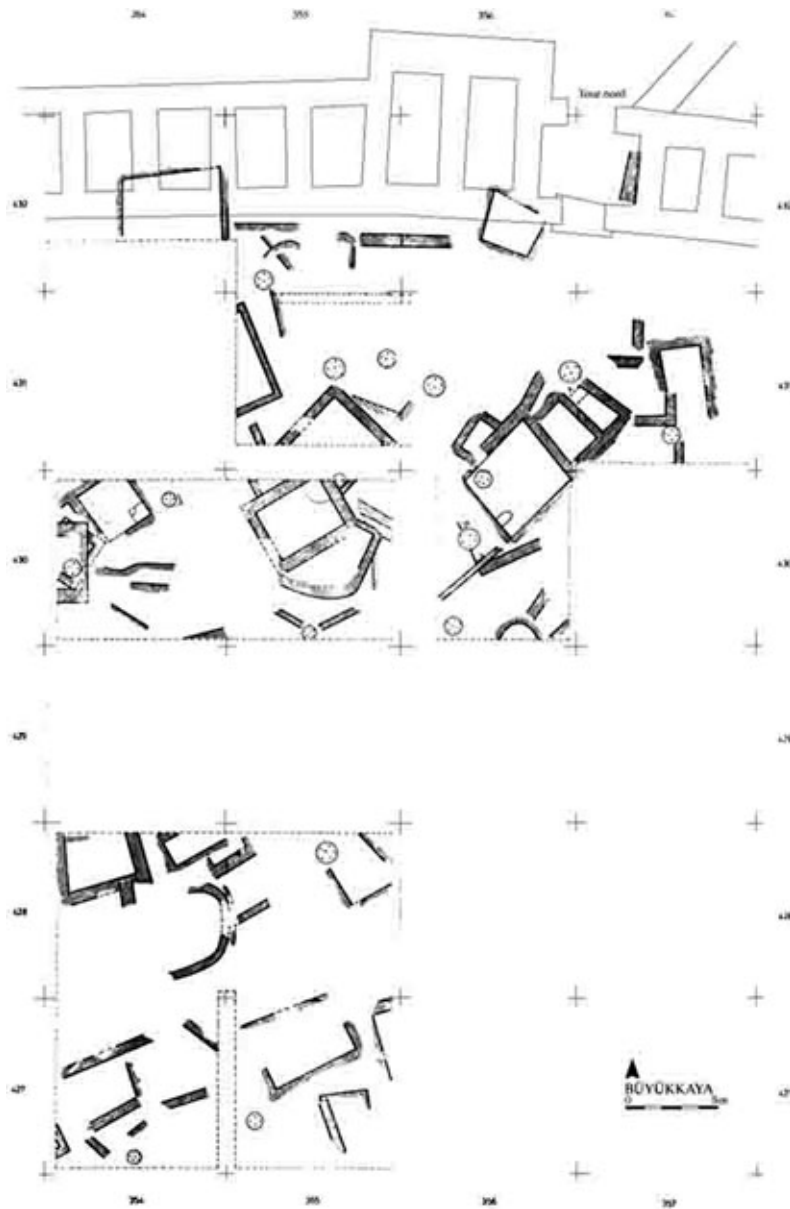

Pl. 31. Une pièce avec un appentis pour le stockage, Büyükkaya²⁷.



²⁷SEEHER, 1998b, 72.

Pl. 32. Enchevêtrement des constructions, Büyükkaya²⁸.



Pl. 33. Le carré 349-352/427-428, Büyükkaya²⁹.

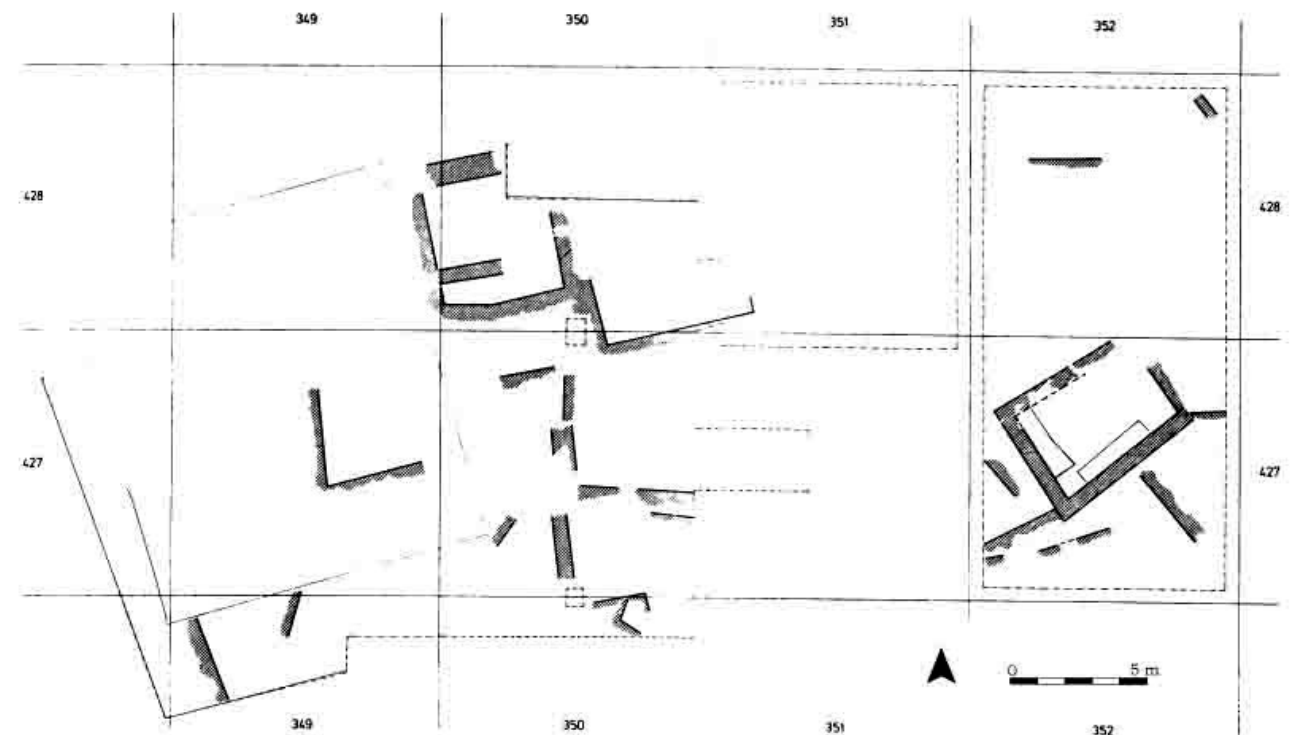

Pl. 34. Plan de situation de Gordion³⁰.

²⁸SEEHER, 1998b, 72.

²⁹SEEHER, 1996, Abb. 18.

³⁰HENRICKSON, VOIGT, 1998, 80, Fig. 1.

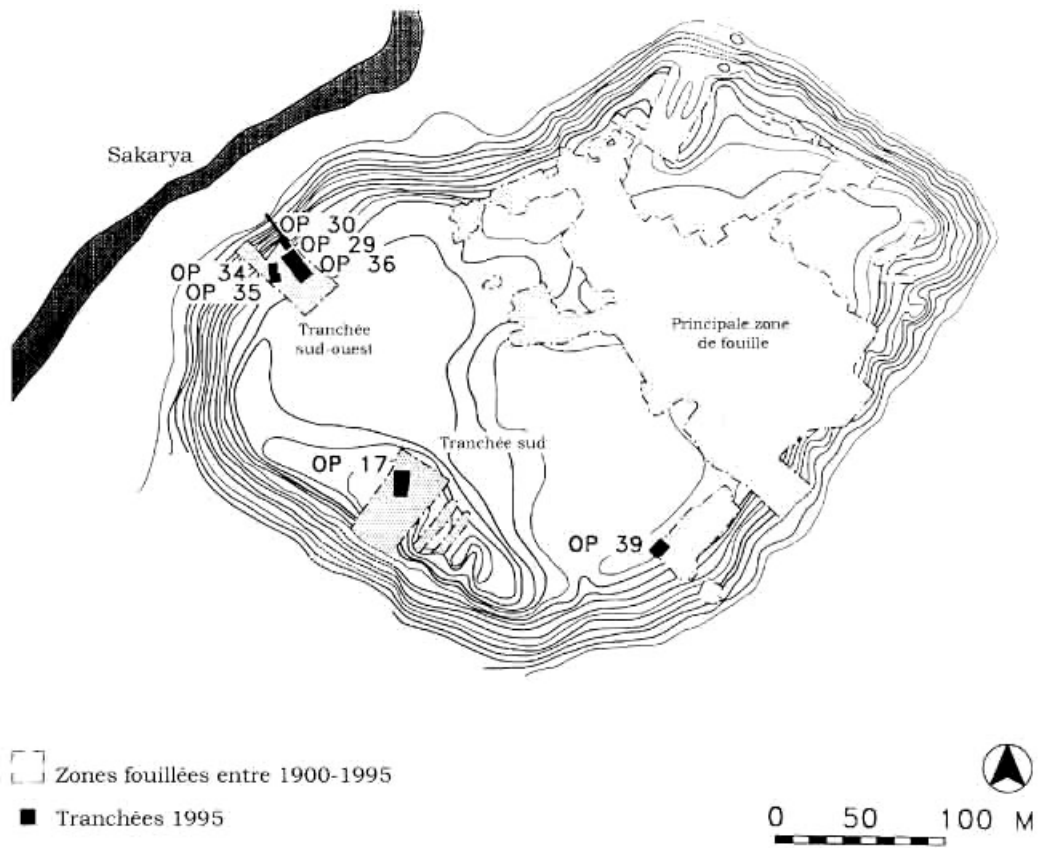

Pl. 35. Enceinte du premier niveau phrygien, Gordion³¹.

³¹DeVRIES, 1987, Fig. 3.

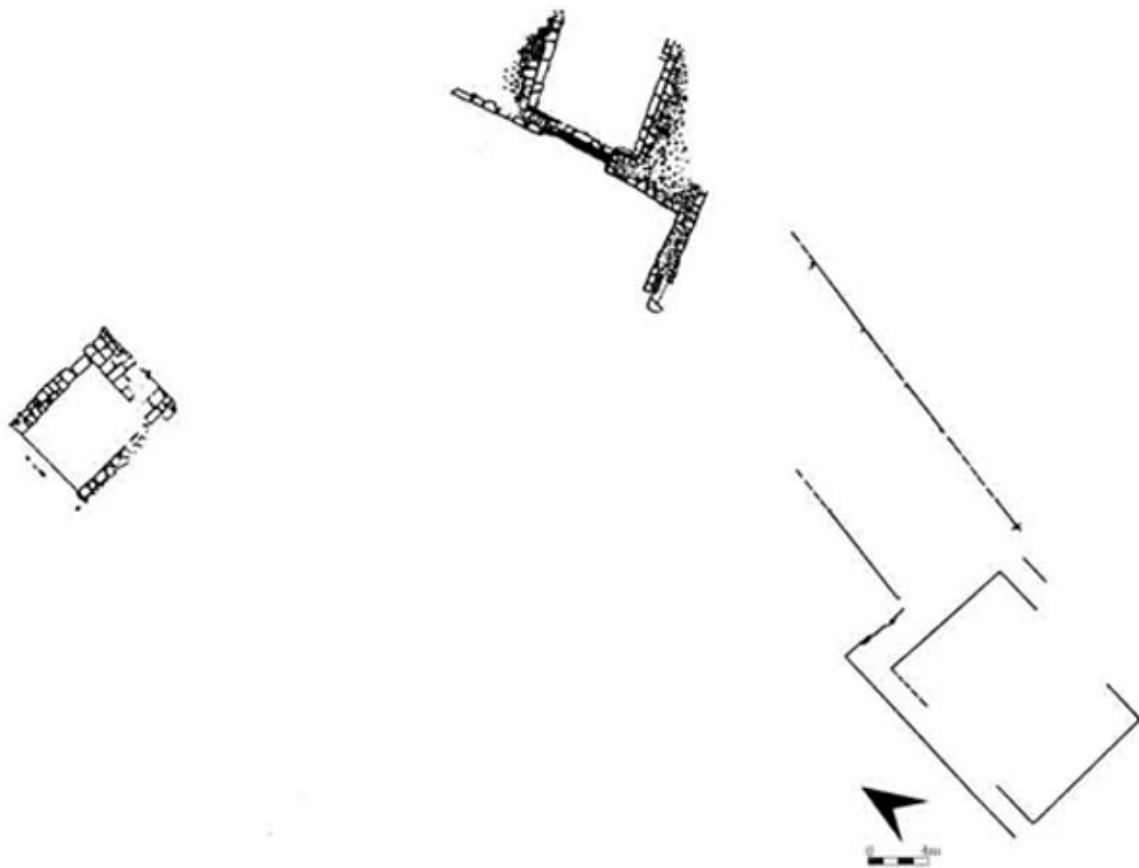

Pl. 36. Constructions des deuxième et troisième niveaux phrygiens, Gordion³².

³²DeVRIES, 1987, Fig. 4.

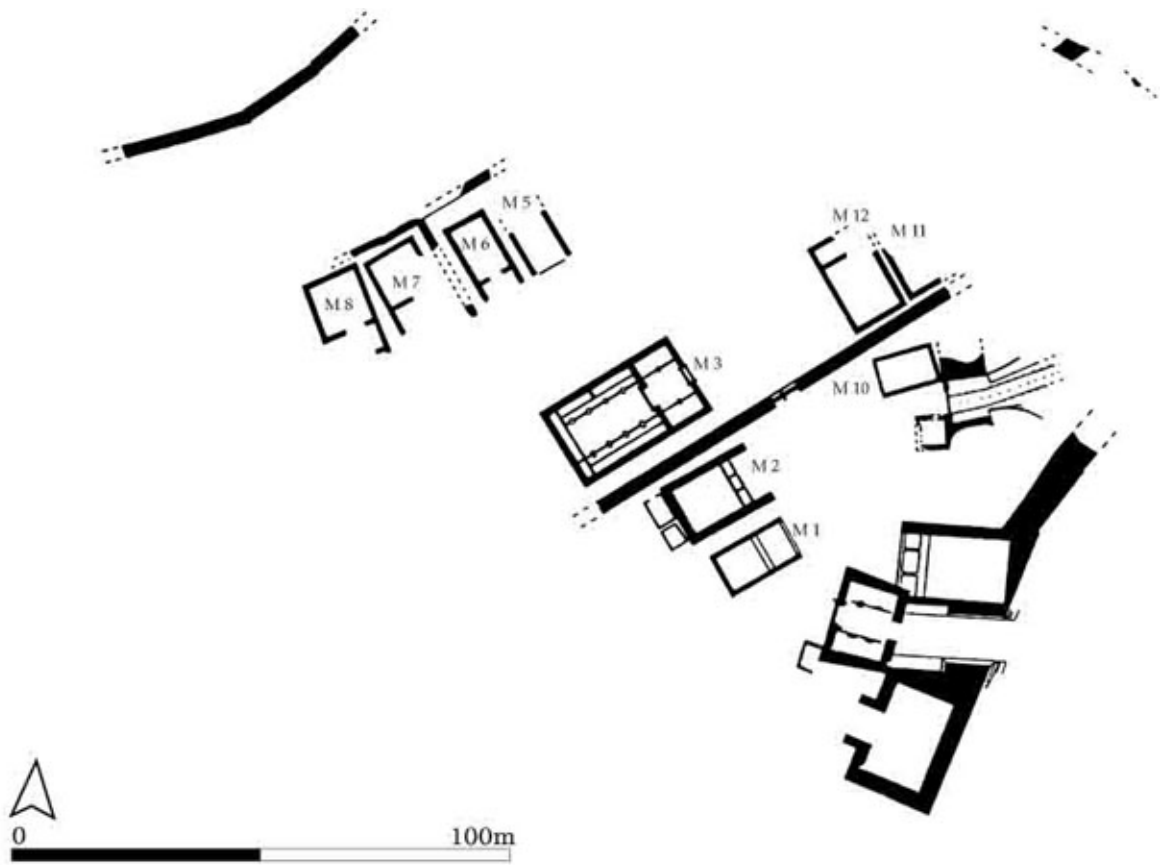

Pl. 37. Plan de détail des *Burned Phrygian Building-Burned Building* (M1) et *West Phrygian House-Mosaic Building* (M2), Gordion³³.

³³YOUNG, 1957a, pl. 88.

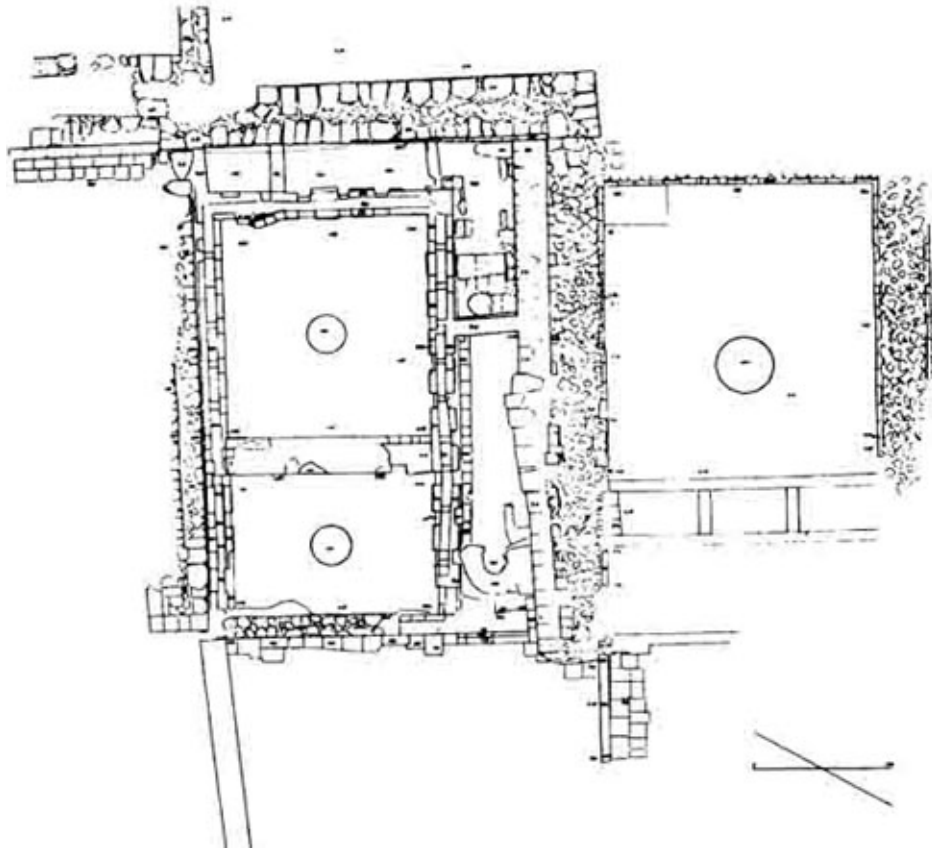

Pl. 38. Acrotère de M2³⁴.

³⁴SAMS, 1994b, Fig. 20. 2.

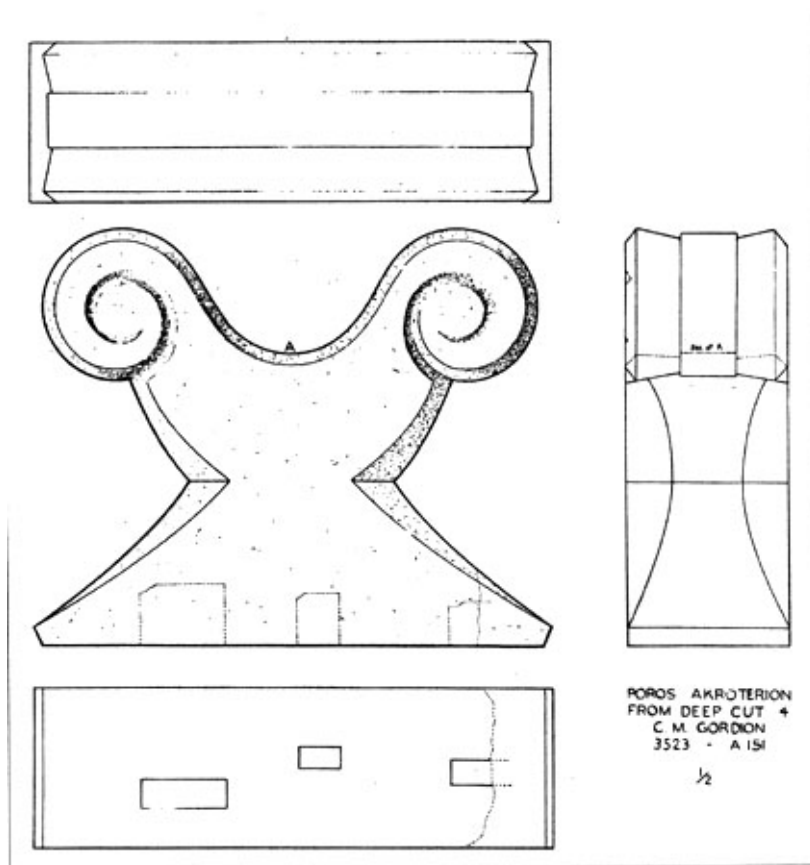

Pl. 39. Élément de toiture à double pente, Gordion³⁵.



Pl. 40. Acrotère du mégaron 9, Gordion³⁶.

³⁵SAMS, 1994b, Pl. 20. 3. 1.

³⁶SAMS, 1994b, Pl. 20. 3. 2.



Pl. 41. L'enceinte du troisième niveau phrygien, Gordion³⁷.

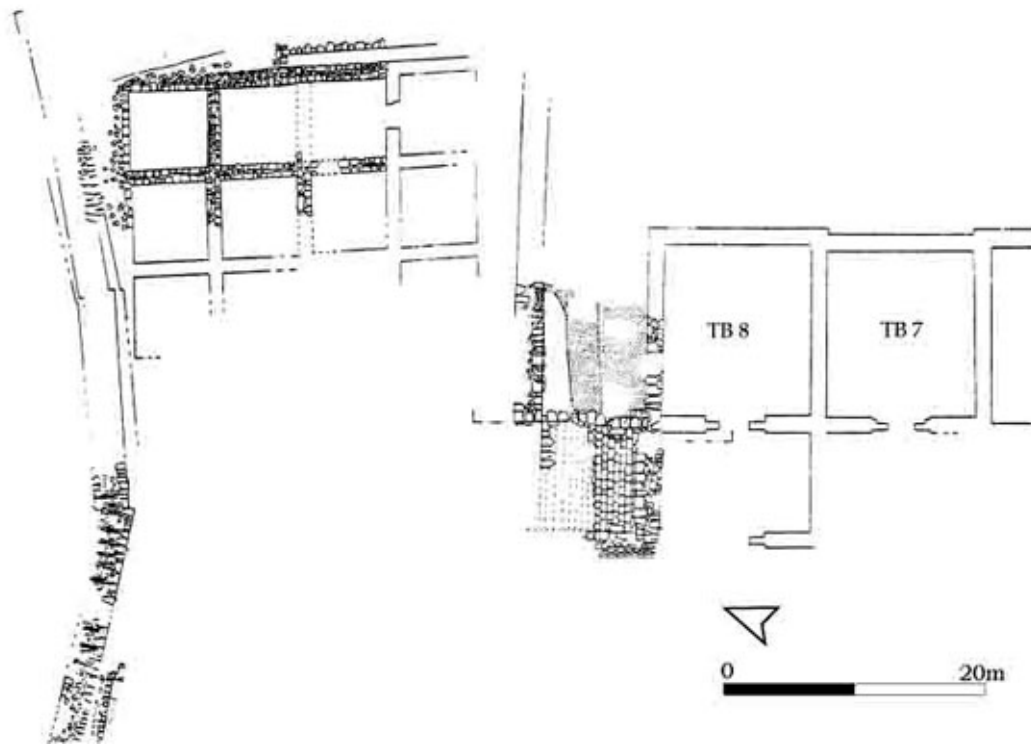

Pl. 42. Les constructions des dernières périodes (4, 5, 6), Gordion³⁸.

³⁷DeVRIES, 1987, Fig. 6.

³⁸DeVRIES, 1987, Fig. 7.

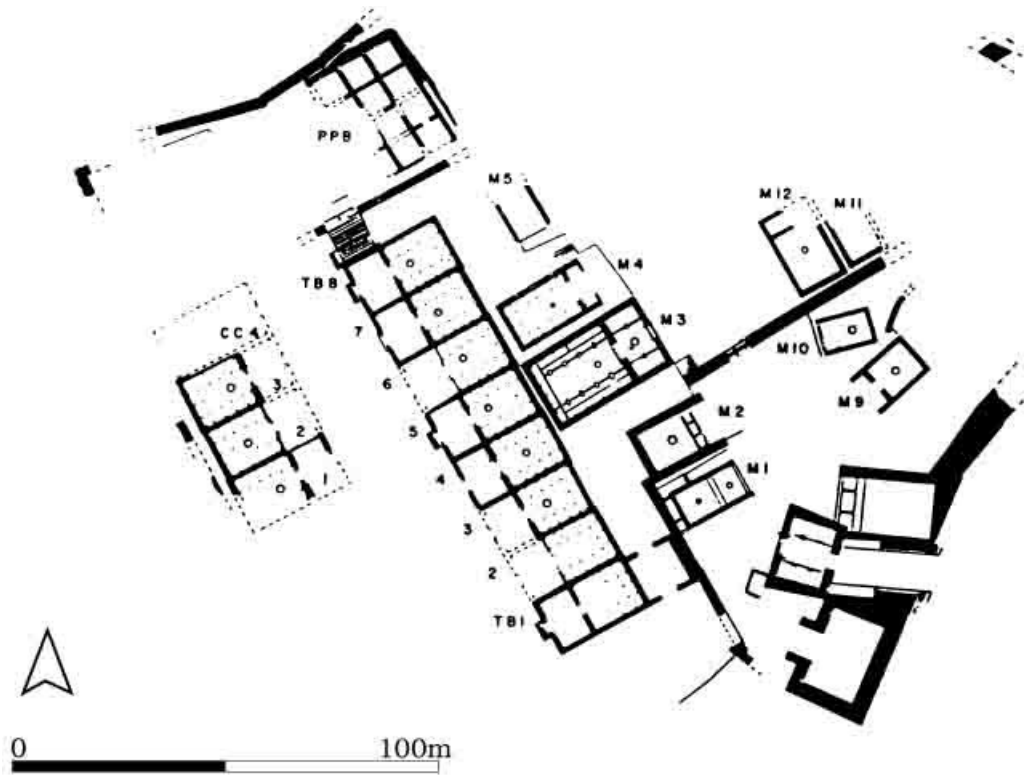

Pl. 43. Les derniers aménagements, la phase 7, Gordion³⁹.

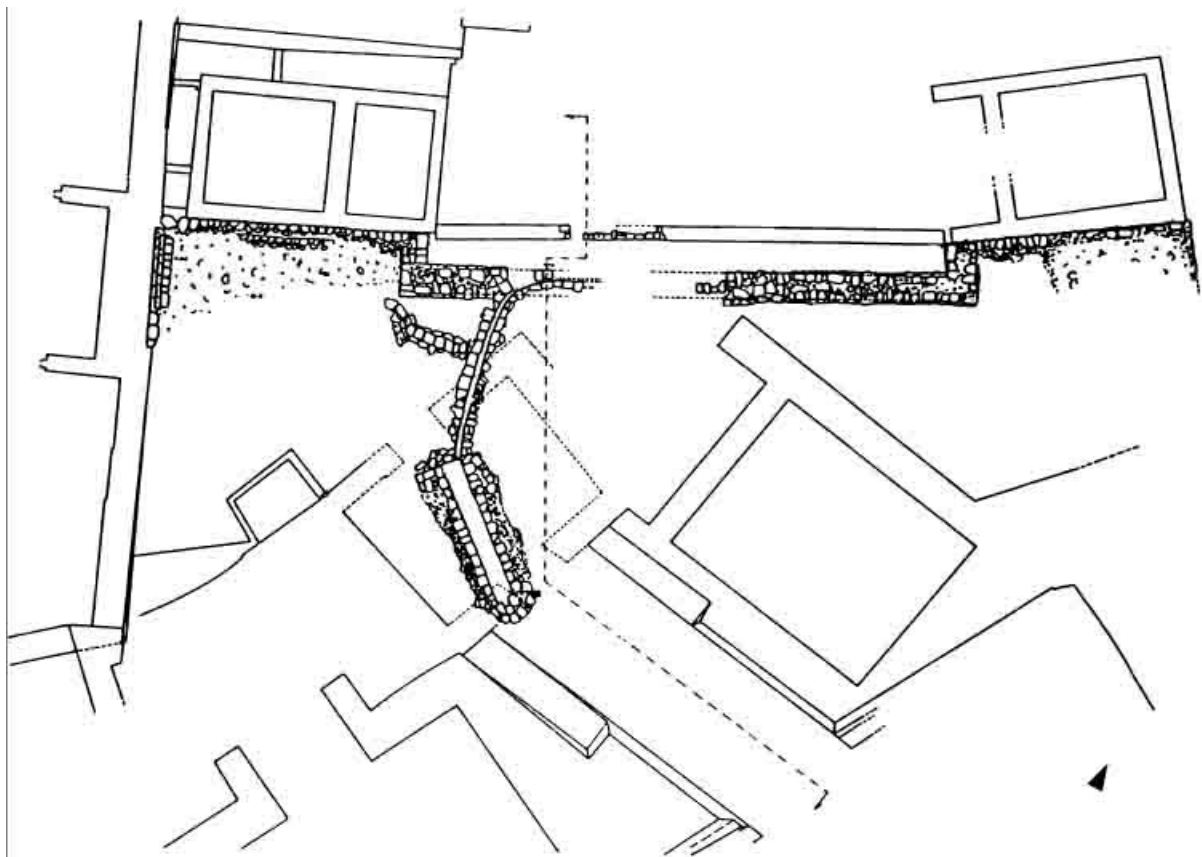

³⁹DeVRIES, 1987, Fig. 8.

Pl. 44. La citadelle sud, Boğazköy⁴⁰.

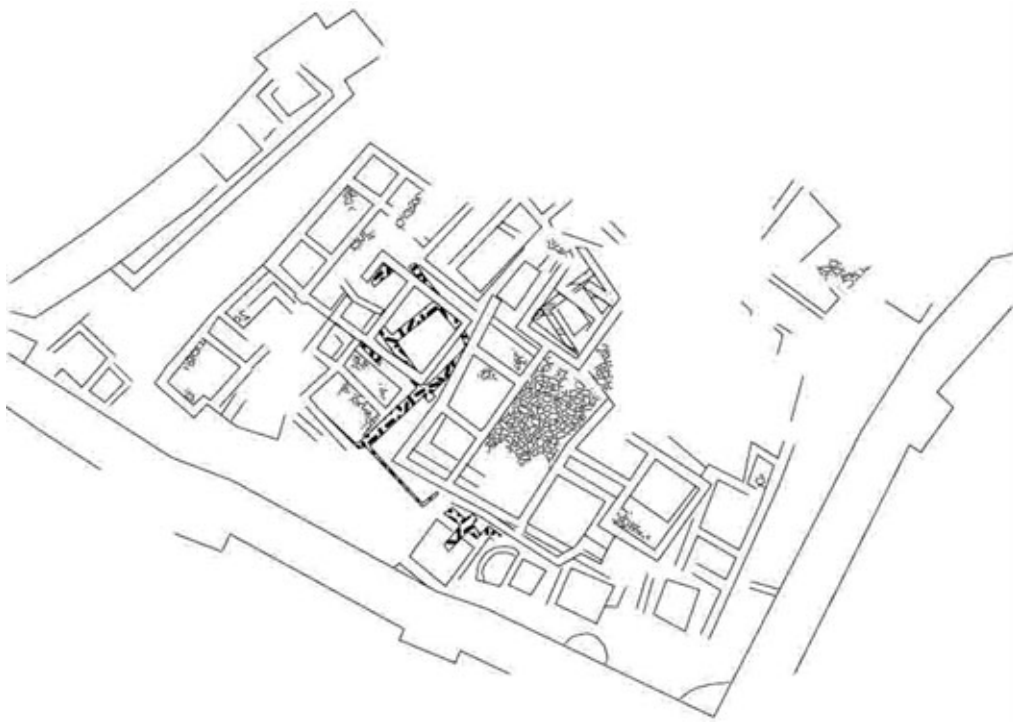

Pl. 45. Plan d'ensemble d'Alışar à la période 4c post-hittite sur la citadelle et à l'âge du Fer sur la terrasse⁴¹.

⁴⁰NEVE, 1990, abb.8.

⁴¹von der OSTEN, SCHMIDT, 1937, 287, Fig. 310.

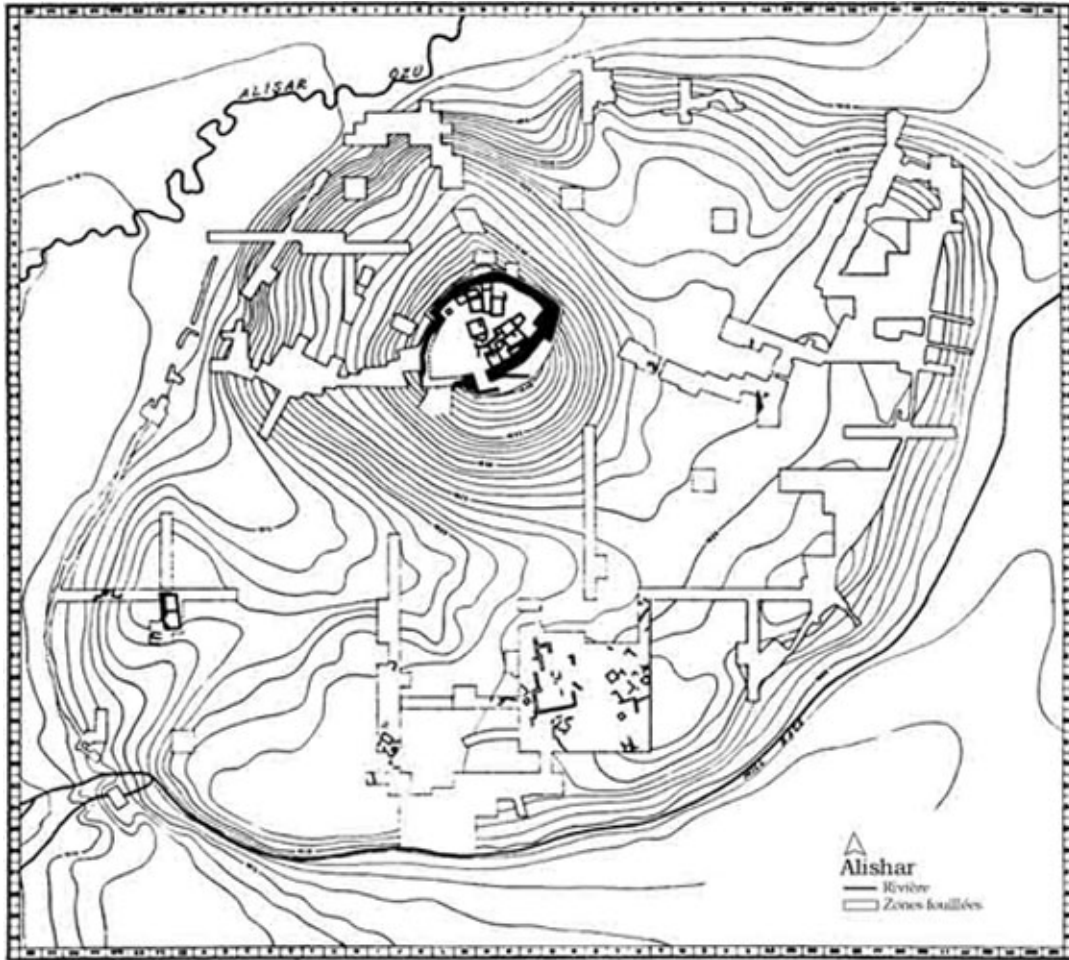

Pl. 46. Plan du site sur le höyük A, Alishar⁴².

⁴²von der OSTEN, MARTIN, MORRISON, 1933, fig. 12.

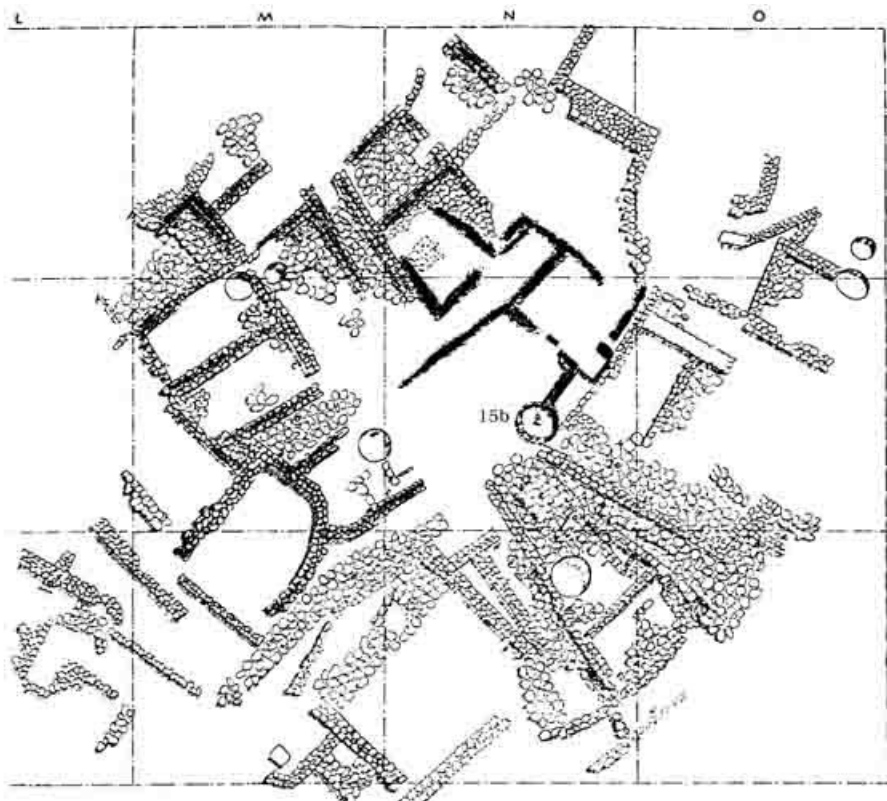

Pl. 47. Plan composite de tous les niveaux de la terrasse sud, Alisar⁴³.

⁴³von der OSTEN, MARTIN, MORRISON, 1933, fig. 28.

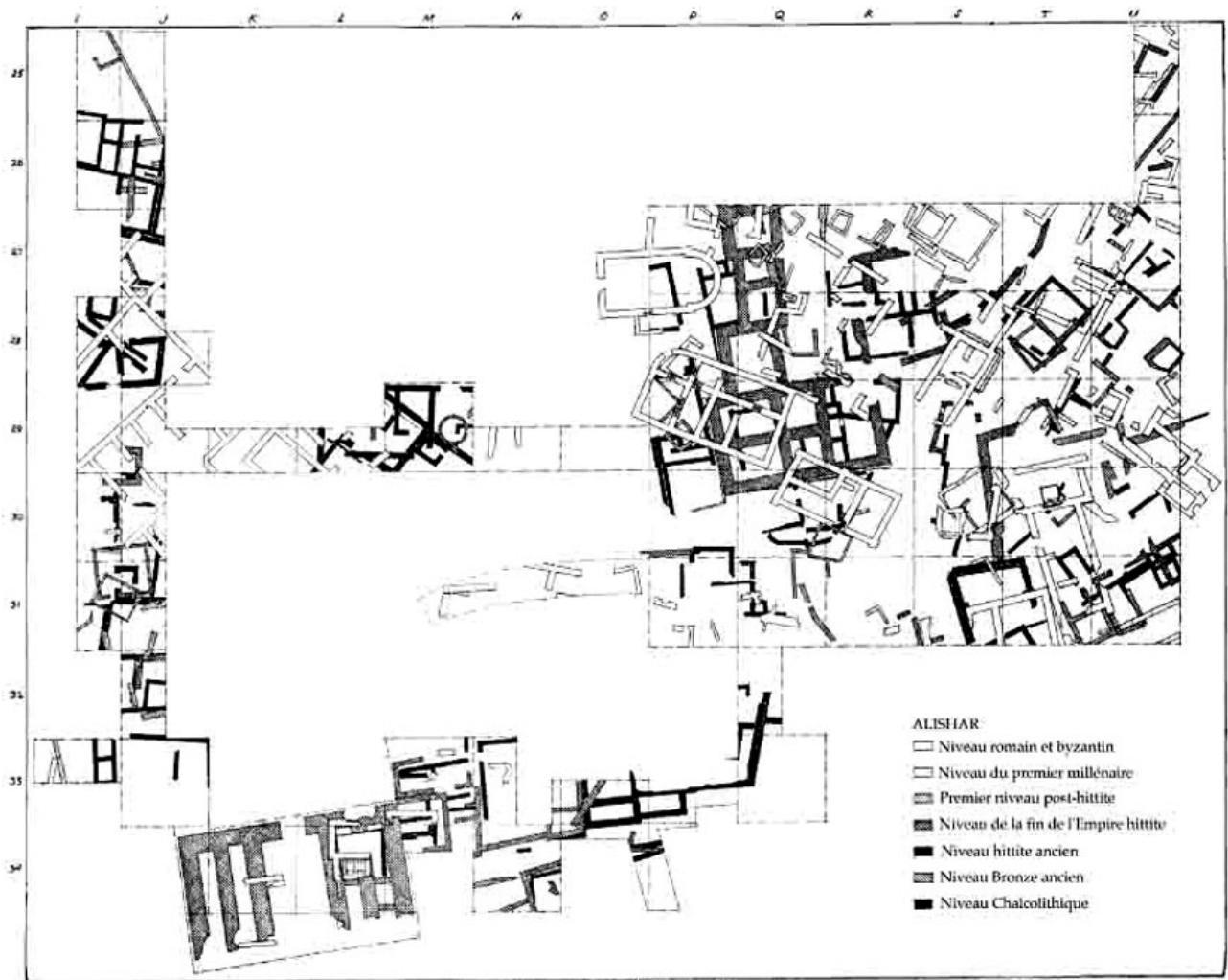

Pl. 48. Plan du niveau 4c sur la citadelle, Alisar⁴⁴.

⁴⁴von der OSTEN, SCHMIDT, 1937, Fig. 327.

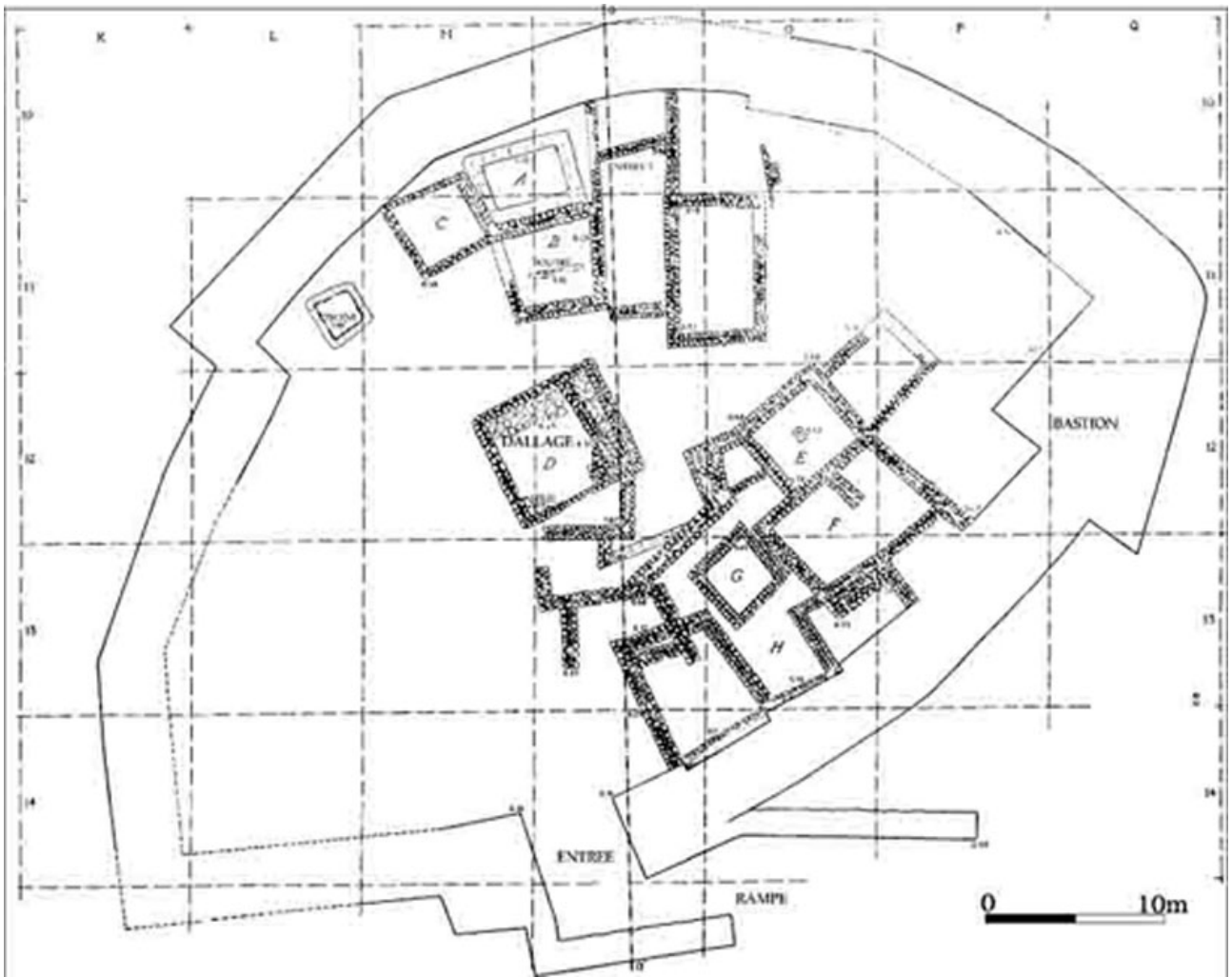

Pl. 49. Plan du niveau 4b sur la citadelle, Alisar⁴⁵.

⁴⁵von der OSTEN, SCHMIDT, 1937, Fig. 335.

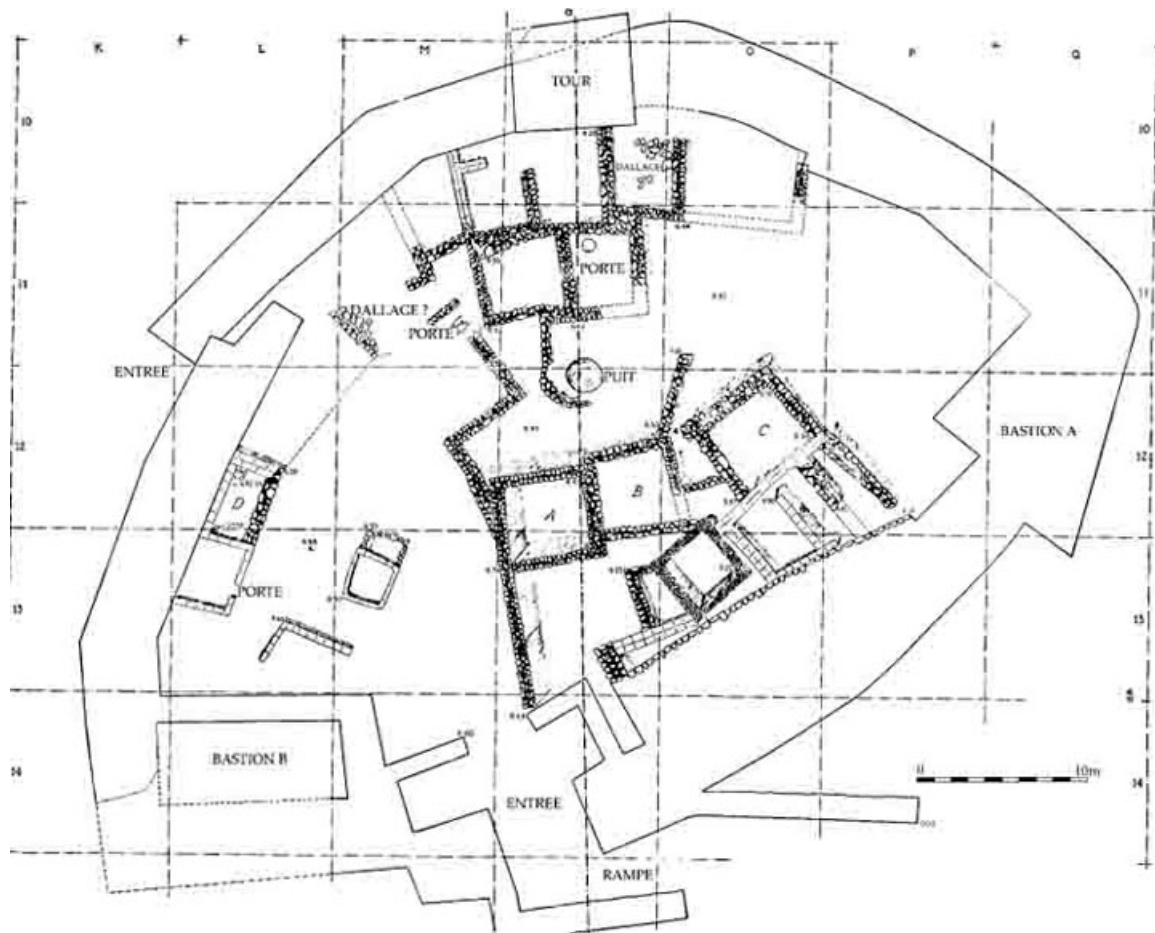

Pl. 50. Plan du niveau 4a sur la citadelle, Alisar⁴⁶.

⁴⁶von der OSTEN, SCHMIDT, 1937, Fig. 348.

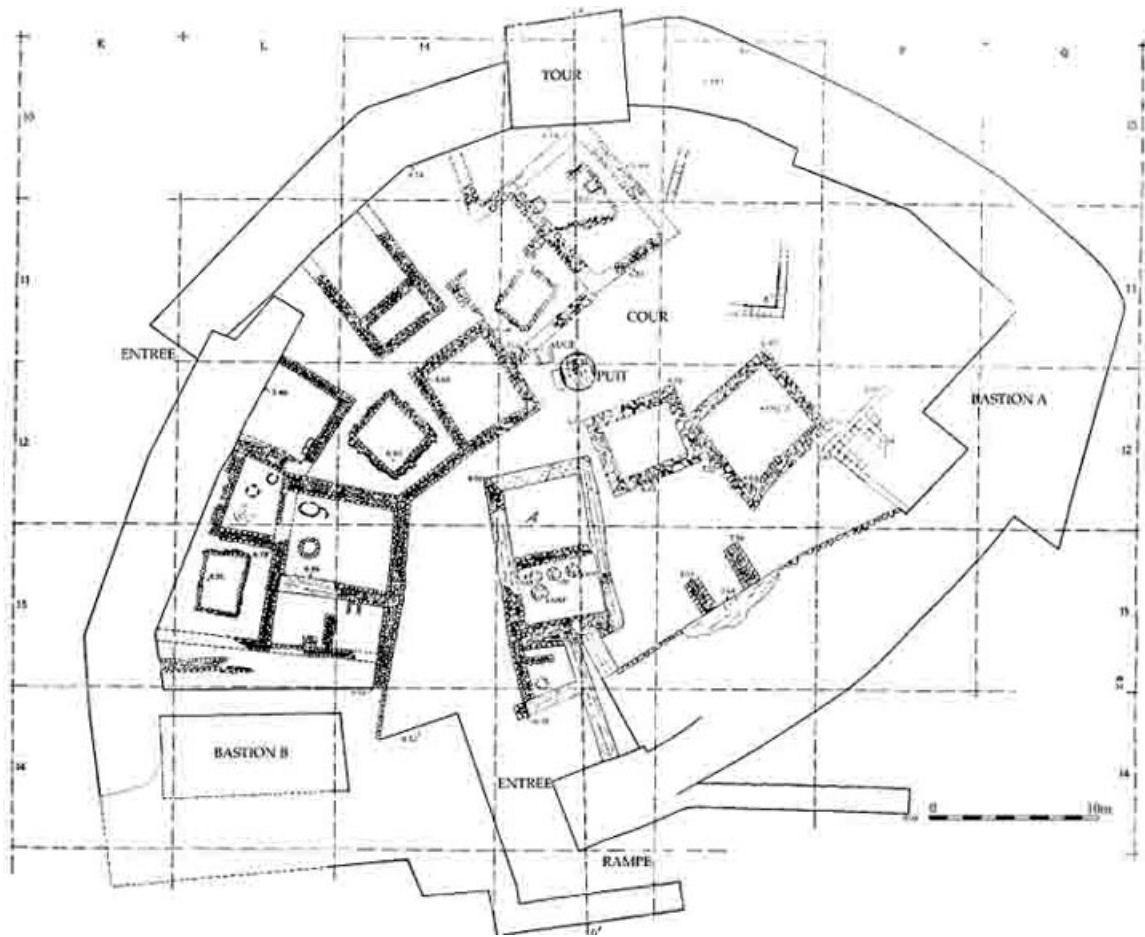

Pl. 51. Plan des structures phrygiennes (en foncé), Alaca⁴⁷.

⁴⁷KOŞAY, 1951, Fig. 5.

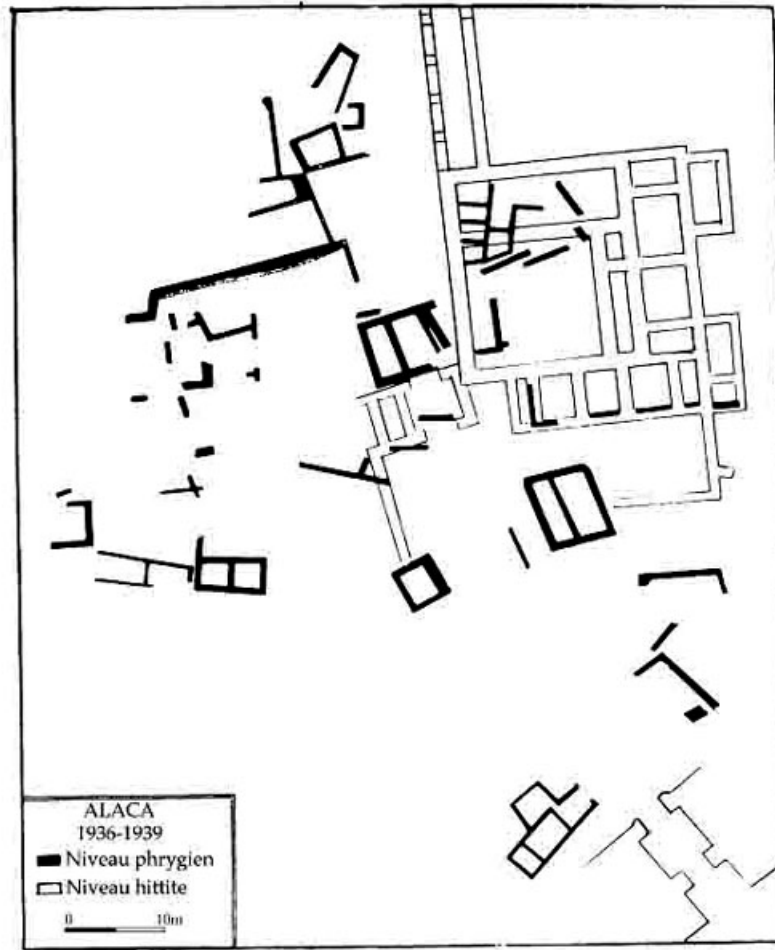

Pl. 52. Plan des murs phrygiens, Alaca⁴⁸.

⁴⁸KOŞAY, AKOK, 1966, Lev. 68.

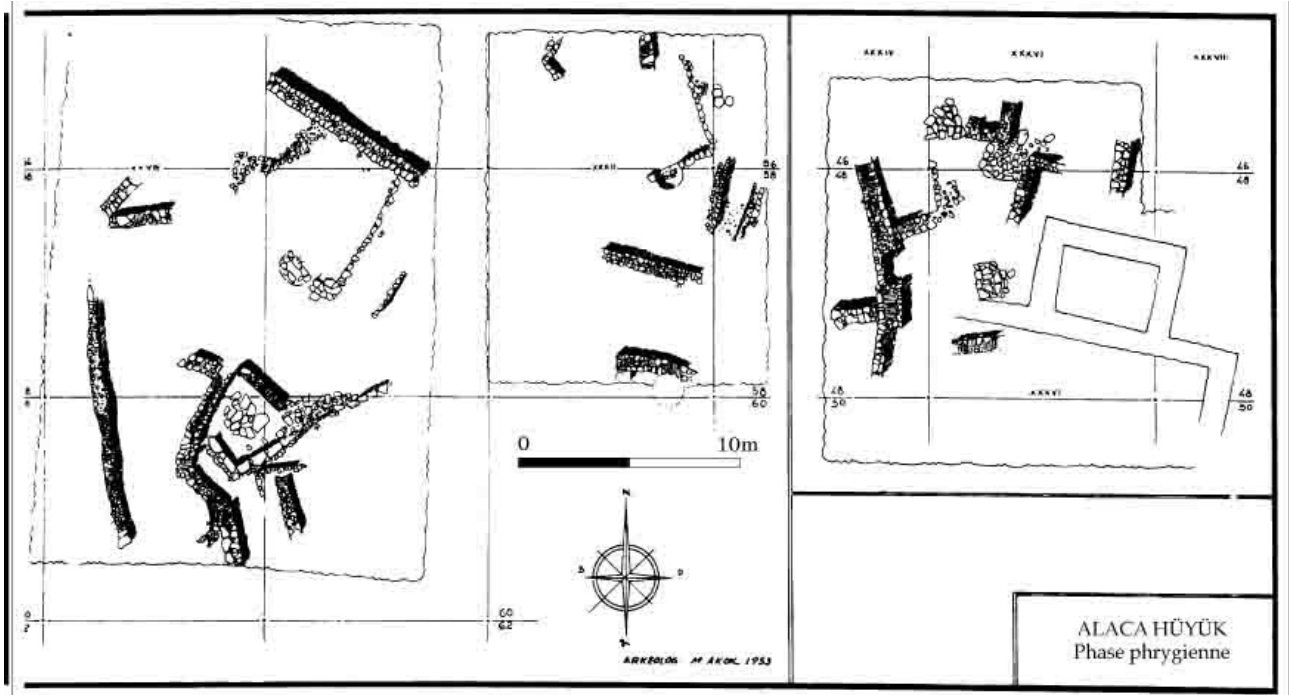

Pl. 53. Restes d'architecture phrygienne, Alaca⁴⁹.

⁴⁹ KOŞAY, 1951, Plan 1.

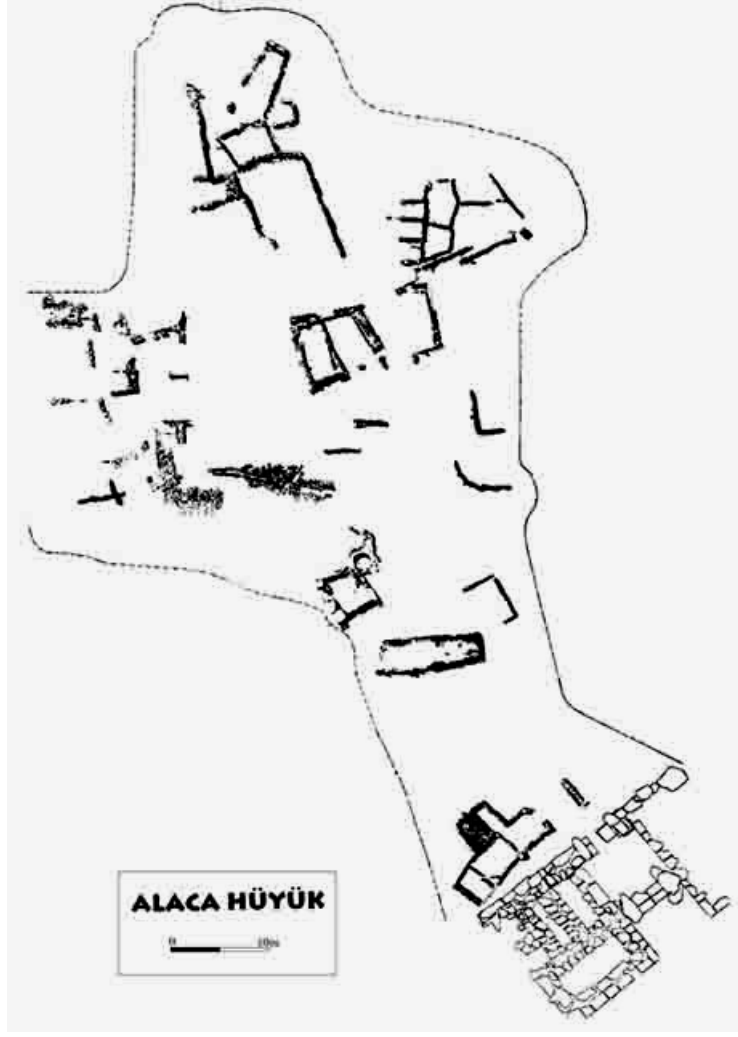

Pl. 54. Plan, Büyük Güllücek⁵⁰.

⁵⁰ KOŞAY, 1957, Taf. IV.

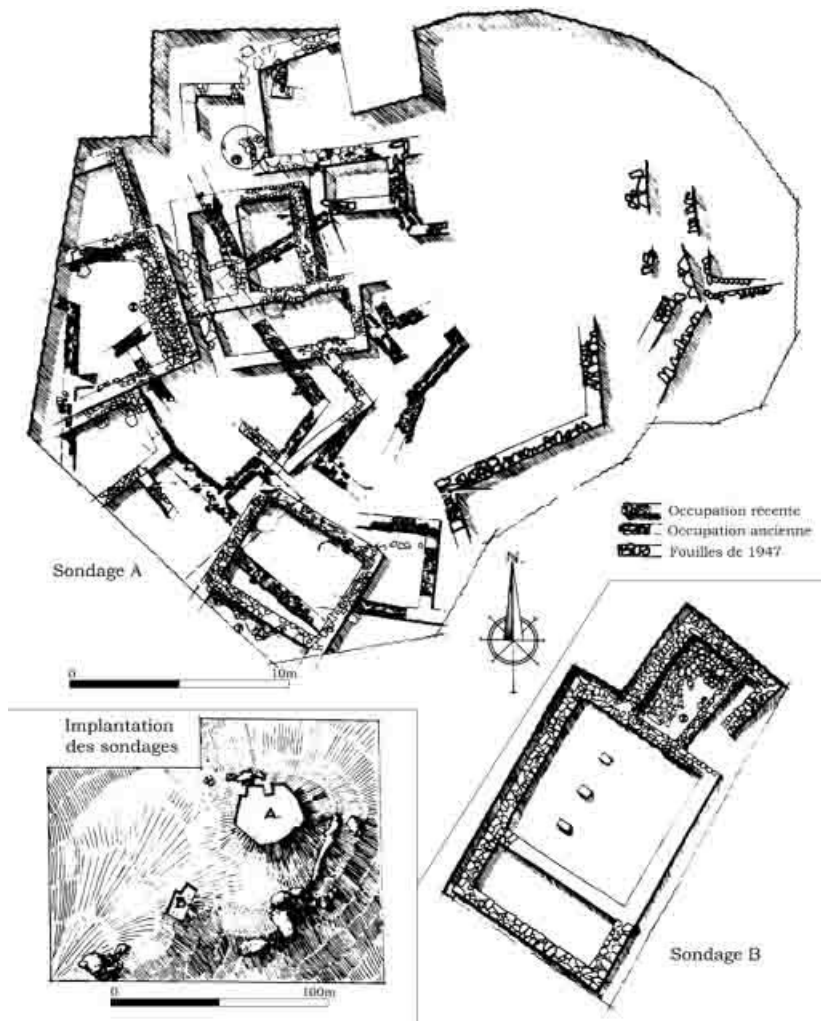

Pl. 55. Plan de Çevre Kale⁵¹.

⁵¹SUMMERS, 1992, 185, Fig. 3.

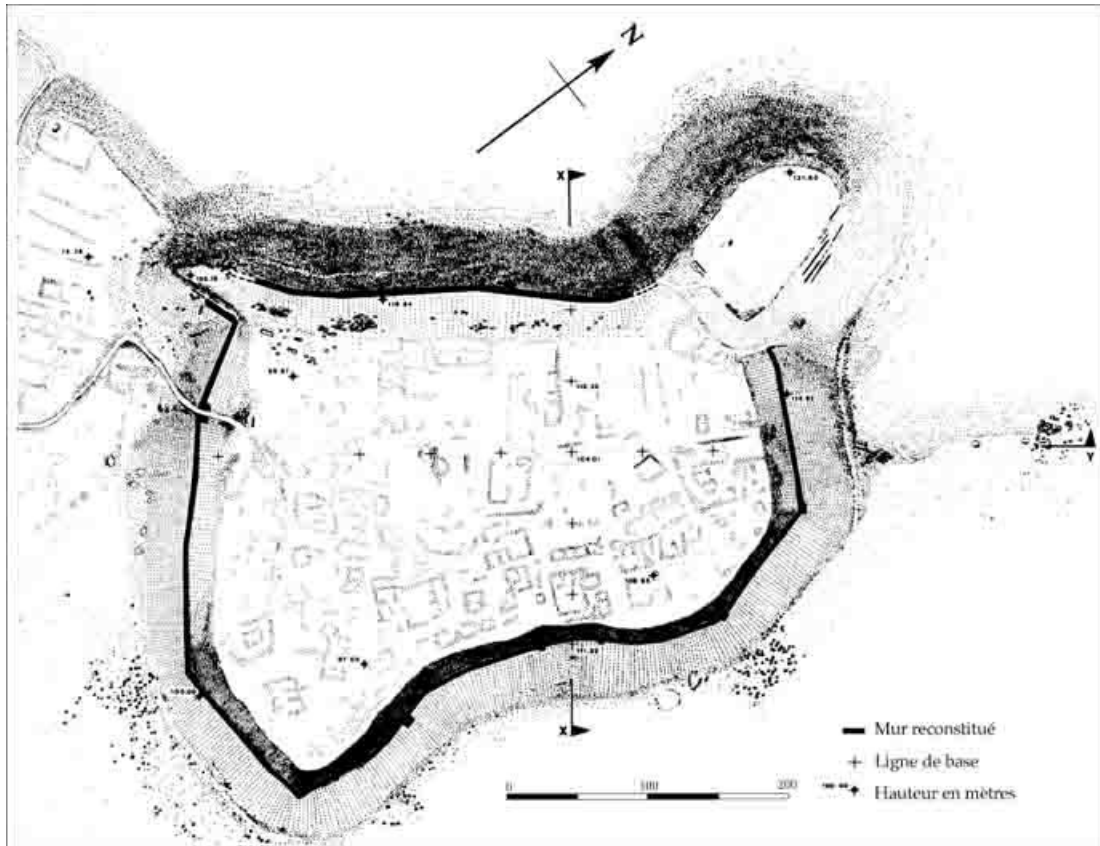

Pl. 56. Niveau 1 des carrés Ü et V/12-13-14, Eskiypar⁵².

⁵²BAYBURTLUOĞLU, 1976, 169.

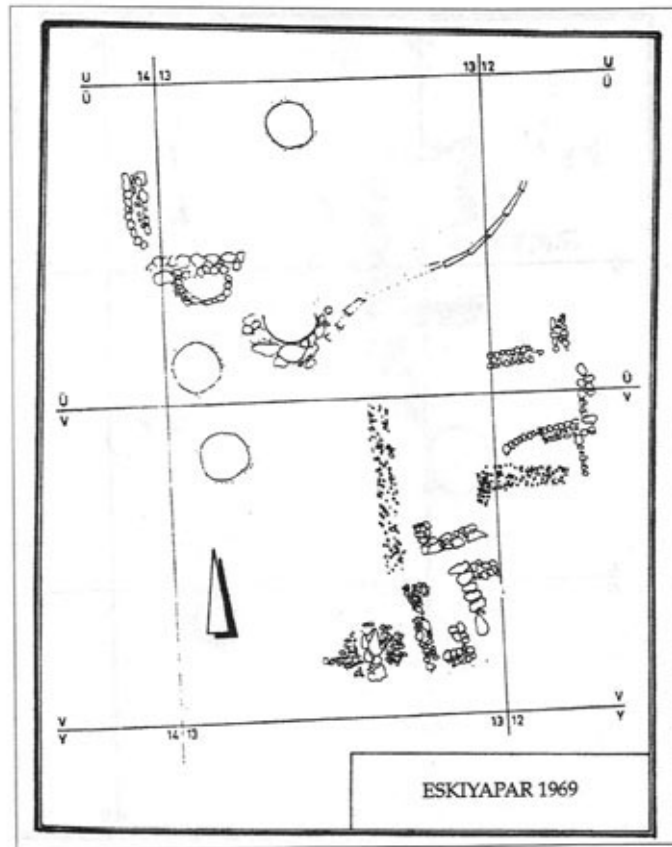

Pl. 57. Niveau 2 des carrés Ü et V/12-13-14, Eskiypar⁵³.

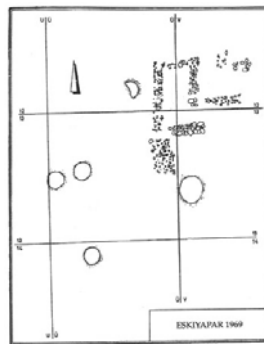

Pl. 58. Niveau des carrés M-N-O/7-8-9, Eskiypar⁵⁴.

⁵³BAYBURTLUOĞLU, 1976, 170.

⁵⁴BAYBURTLUOĞLU, 1976, 171.



Pl. 59. Plan du site, Göllüdağ⁵⁵.

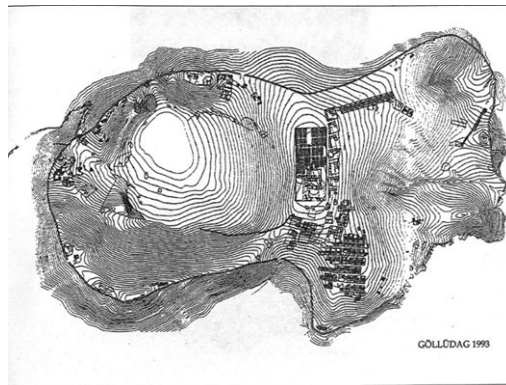

Pl. 60. Deux lions provenant de Göllüdağ, trouvés avant les recherches de Tezcan⁵⁶.

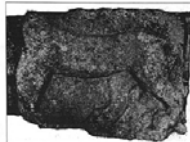

Pl. 61. Les niveaux 1, 3 et 4, Karahöyük⁵⁷.

⁵⁵GATES, 1995, 229, fig. 16.

⁵⁶BITTEL, SCHNEIDER, 1940, 570, Abb. 5.

⁵⁷ÖZGÜÇ, 1949, Plân 5.

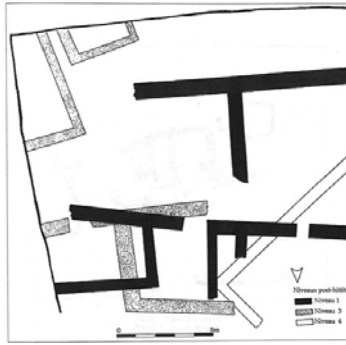

Pl. 62. Plan, Kültepe⁵⁸.

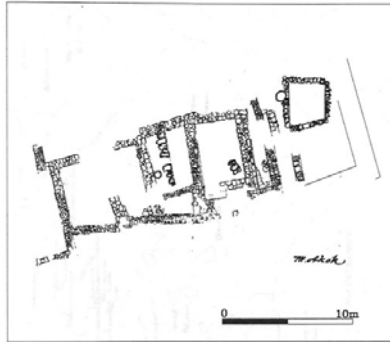

Pl. 63. Carte de répartition des tombes⁵⁹.

⁵⁸ÖZGÜÇ, 1971, Res. 2.

⁵⁹PRAYON, WIRKKE, 1994, Karte 3.

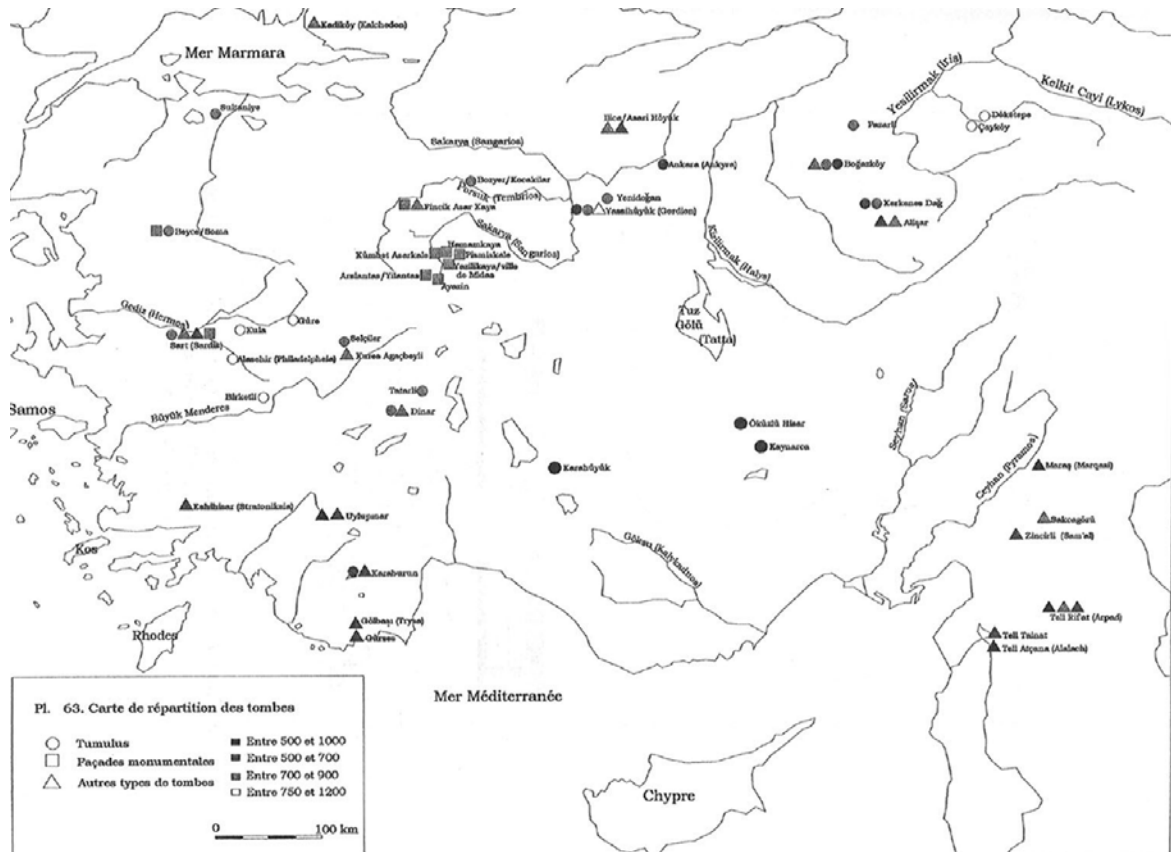

Pl. 64. Section, plan du tumulus ; section, plan de la chambre, Tumulus P, Gordion⁶⁰.

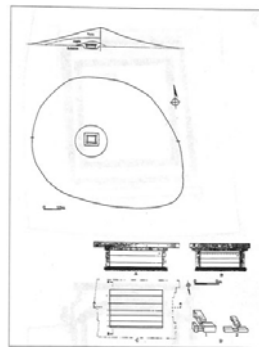

Pl. 65. Plan et section est-ouest de la chambre avec restauration de la superstructure, tumulus MM, Gordion⁶¹.

⁶⁰YOUNG, 1981, fig. 3-4.

⁶¹*Ibid.*, fig. 61-62.

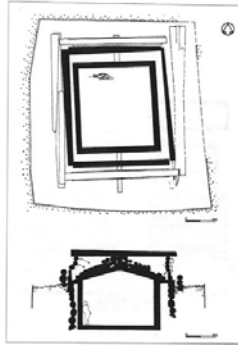

Pl. 66. Section, plan du tumulus ; section, plan de la chambre, Tumulus W, Gordion⁶².

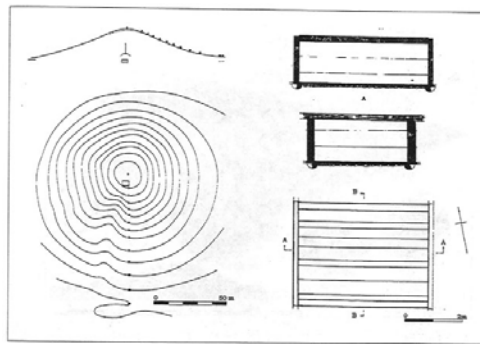

Pl. 67. Tumulus 1, proximité du mausolée d'Atatürk, Ankara⁶³.

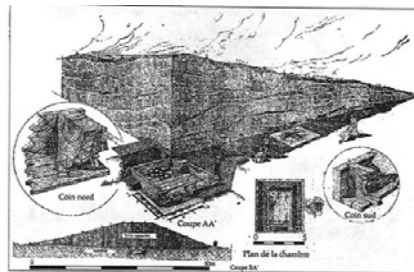

Pl. 68. Tumulus 2, proximité du mausolée d'Atatürk, Ankara⁶⁴.

⁶² *Ibid.*, fig. 114-115.

⁶³ ÖZGÜÇ, AKOK, 1947, Res. 5.

⁶⁴ ÖZGÜÇ, AKOK, 1947, Res. 27.

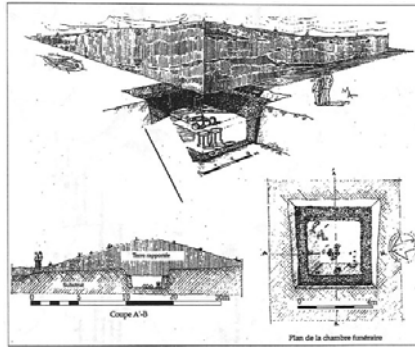

Pl. 69. Carte de répartition des sculptures⁶⁵.

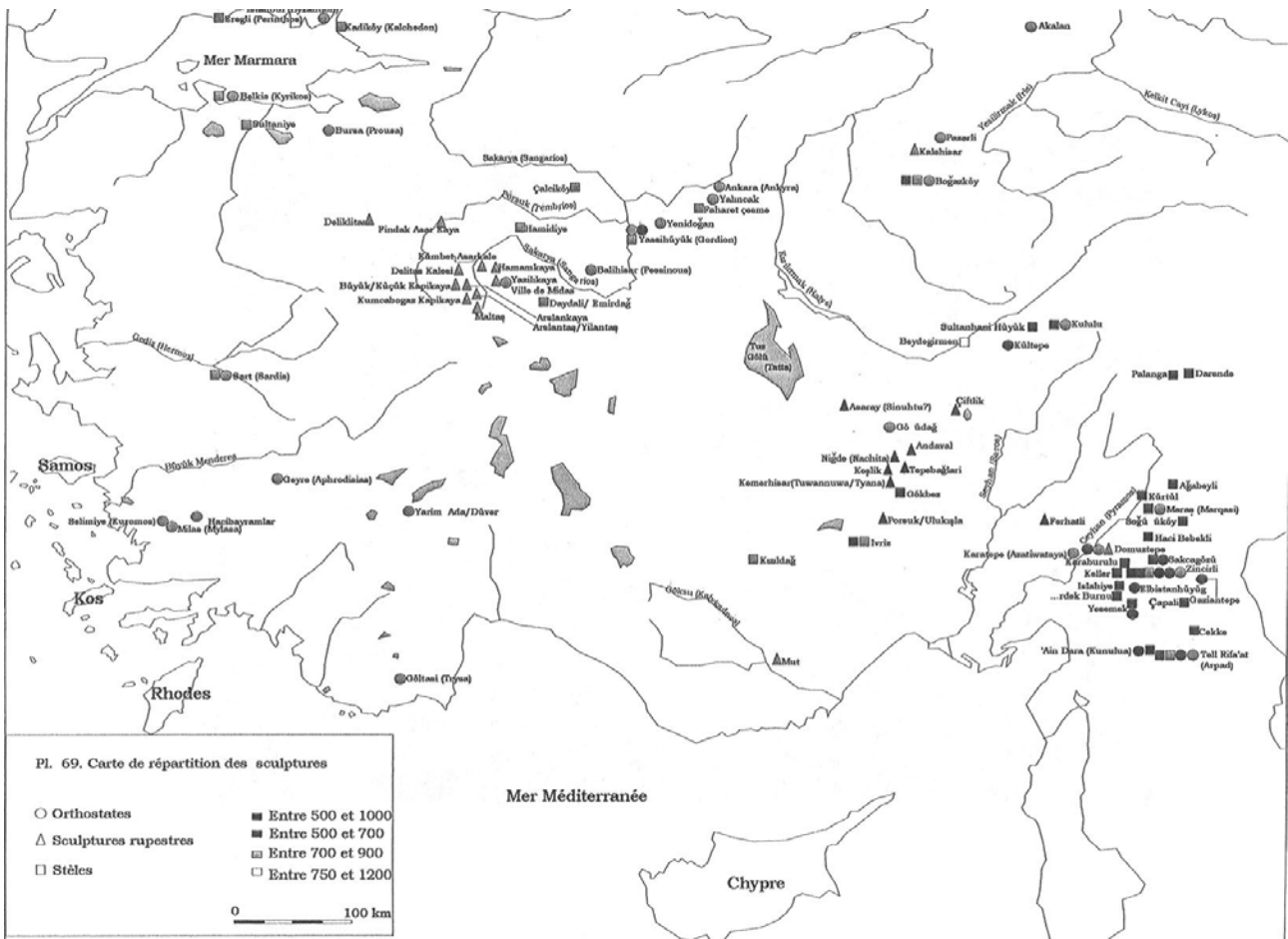

Pl. 70. Relief, Ivriz⁶⁶.

⁶⁵ PRAYON, WIRKKE, 1994,

⁶⁶BITTEL, 1976, fig. 328.



Pl. 71. Relief, Ivriz-Ambardesi⁶⁷.



Pl. 72. Relief, Gökbez⁶⁸.



Pl. 73. Stèle, Babylone⁶⁹.

⁶⁷BITTEL, 1976, fig. 329.

⁶⁸FAYDALI, 1974, fig.1.

⁶⁹BITTEL, 1976, fig. 322.



Pl. 74. Stèle, Niğde⁷⁰.



Pl. 75. Stèle détail, Niğde⁷¹.



Pl. 76. Région, Keşlik⁷².

⁷⁰KALAÇ, 1976, Res. 6.

⁷¹KALAÇ, 1976, Res. 6.

⁷²ÇINAROĞLU, 1989, Fig. I. 1.

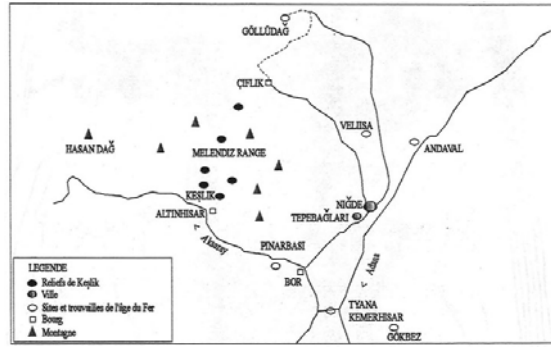

Pl. 77. Stèle, Keşlik⁷³.



Pl. 78. Stèle, Bor⁷⁴.



Pl. 78 bis. Relief, Çiflik⁷⁵.

⁷³ÇINAROĞLU, 1989, fig. II.1.

⁷⁴BITTEL, 1976, fig. 330.

⁷⁵ORTHMANN, 1971, Tafel 5.



Pl. 78 ter. Relief, Andaval⁷⁶.



Pl. 79. Orthostate avec un taureau, Ankara⁷⁷.



Pl. 80. Orthostate avec un lion, Ankara⁷⁸.



Pl. 81. Orthostate avec un griffon, Ankara⁷⁹.

⁷⁶USSISHKIN, 1967, CIII, fig. 2.

⁷⁷BITTEL, 1976, fig. 335.

⁷⁸BITTEL, 1976, fig. 336.



Pl. 82. Deux lions d'une porte monumentale, Göllüdağ⁸⁰.



Pl. 83. Orthostate, Kültepe⁸¹.



Pl. 84. Statue en pied et tête, Kululu⁸².



Pl. 85. Bol incisé, Gordion⁸³.

⁷⁹BITTEL, 1976, fig. 337.

⁸⁰BITTEL, 1976, fig. 323.

⁸¹BITTEL, 1976, Fig. 321.

⁸²BITTEL, 1976, fig. 325 et 320.

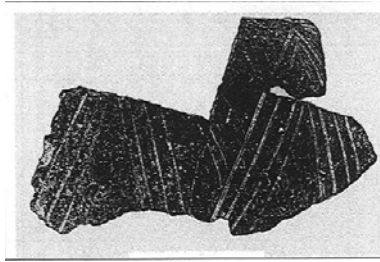

Pl. 86. Tableau des technologies et de l'organisation de la production, Gordion⁸⁴.

Observations	YHSS 7B Non-tournée	YHSS 7A Chamois	YHSS 6-5 Commune	YHSS 6-5 Fine
Répertoire des formes/des techniques de finition	Limité	Relativement limité	Large	Limité
Méthodes de formation de base	Fait à la main (colombin, plaquette, moulé?)	Fait à la main (colombin, plaquette), tourné ?	Tourné ou fait à la main (selon le vase)	Tourné
Méthodes de finition de base	Bruni sur engobe ou <i>self slip</i> ¹	Lissé, engobe ou <i>self slip</i>	Lissé, engobe ou <i>self slip</i>	Engobe ou <i>self slip</i> , bruni, poli
Atmosphère de cuisson	Réductrice	Incertain à cause de l'incendie	Généralement réductrice	Généralement réductrice
Effort déployé par vase	Modéré à élevé	Bas à modéré	Bas à modéré	Elevé
Complexité des outils/investissement [*]	Brunisseur	Tournette (tour ?)	Tournette Tour	Tour
Assemblage, typologie Formes basiques	Peu, simple	Relativement peu ?	Relativement peu, simple, standardisé	Peu, souvent élaboré
Variabilité	Marquée	Modérée ?	Relativement mineure à modéré	Mineure à modérée

¹ Selon la définition de DUPRE, 1983, 18, qui se fonde lui-même sur SHEPARD, 1965, 192.

Pl. 87. Comparaison des techniques utilisées à l'âge du Bronze et au début de l'âge du Fer, Gordion⁸⁵.

Observations	YHSS 8 Céramique chamois	YHSS 8 cuisine	YHSS 7B Non tournée
Techniques d'élaboration et de formation	Large	Très limitées	Limitées
Elaboration basique	Tour, Tournette, faite à la main	Faite à la main (enroulée ?)	Faite à la main (enroulée, tablettes, moulée)
Finition basique	Lissage (<i>self slip</i>)	Grossièrement lissé, (<i>self slip</i>)	Brunissage, (<i>self slip</i>)
Atmosphère de cuisson	Oxydante	Oxydante	Réductrice
Effort pour chaque vase	Bas à modéré	Bas	Modéré à haut
Complexité des outils / Investissement	Tour, Tournette, Aire de travail (atelier ?)	Tournette ?	Brunissoir
Assemblage de la Typologie	Peu, simple, standardisé	Une forme basique	Peu, simple
Variabilité	Mineure	Mineure	Marquée

Pl. 88. Tableau des technologies et de l'organisation de la production, Gordion⁸⁶.

⁸³SAMS, 1992, fig. 8.1.

⁸⁴HENRICKSON, 1994, 101.

⁸⁵HENRICKSON, 1994, 104.

Conclusions	YHSS 7B Non-tournée	YHSS 7A Chamois	YHSS 6-5 Commune	YHSS 6-5 Fine
Organisation de la production	Simple dans la maisonnée	Simple atelier ?	Relativement complexe (ateliers)	Complexe (atelier)
Type de potiers	Amateur	Spécialiste ?	Spécialistes	Spécialistes selon les compétences
Nombre de potiers	Nombreux	Relativement peu	Relativement peu	Peu
Echelle de production	Petite, selon les besoins	Inconnue	Probable	Probable
Division du travail	Peu probable	Possible	Temps partiel/complet	Temps partiel/complet
Temps	<i>Ad hoc</i>	Au moins à temps partiel ?	Tournette Tour	Tour
Saisonnalité	<i>Ad hoc</i>	Quand c'est possible	Quand c'est possible	Quand c'est possible
Marché/utilisateur de base	Maisonnée	Site et alentours ?	Local ou régional	Local ou régional pour une partie de la société

Pl. 89. YHSS 7A, céramique provenant d'une fosse, Gordion⁸⁷.

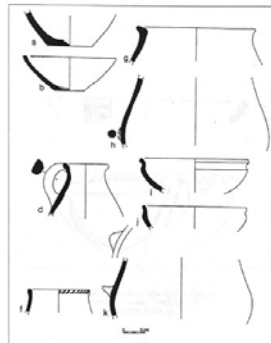

Pl. 90. Tessons incisés, Çadir, Kaman⁸⁸.

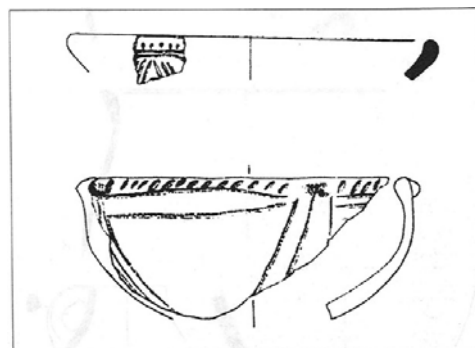

⁸⁶HENRICKSON, 1994, 102.

⁸⁷HENRICKSON, 1994, fig. 10.4.

⁸⁸GORNY *et alii.*, 1995, fig. 19. OMURA, 1992, pl. 8.

Pl. 91. Céramique provenant d'une fosse, Gordion⁸⁹.

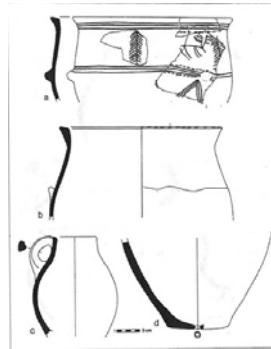

Pl. 92. Céramique provenant de BRH, Gordion⁹⁰.

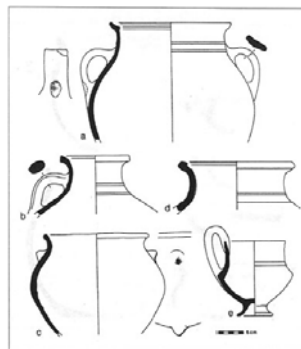

Pl. 93. Poterie du Fer ancien, Gordion⁹¹.



Pl. 94. Bols et vases fermés, Büyükkaya⁹².

⁸⁹HENRICKSON, 1994, fig. 10.3.

⁹⁰HENRICKSON, 1994, fig. 10.5.

⁹¹HENRICKSON, 1994, fig. 10.6.

⁹²SEEHER, 1997, Abb. 12.

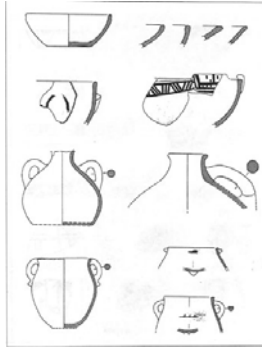

Pl. 95. Vases peints, Büyükkaya⁹³.

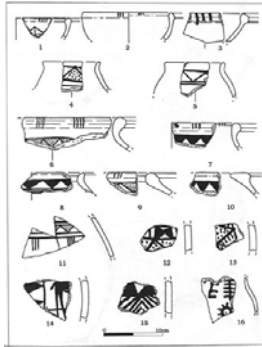

Pl. 96. Bols, pichets et jarres, Büyükkaya⁹⁴.



Pl. 97. Pichets, jarres, Eskiypar⁹⁵.

⁹³SEEHER, 1996, Abb. 21.

⁹⁴SEEHER, 1998, Abb. 23.

⁹⁵BAYBURTLUOĞLU, 1976, Res. 1-3.



Pl. 98. Motifs de triangles pendants hachurés ou à pointillés, pichet à bec latéral, Eskiypar⁹⁶.

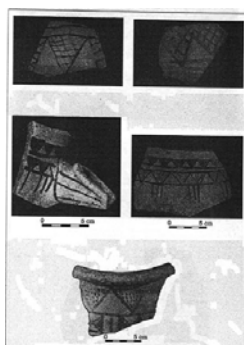

Pl. 99. Tessons, vases peints, Büyükkaya⁹⁷.

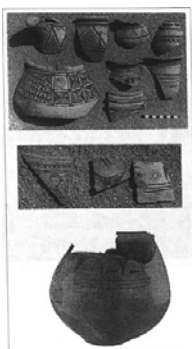

Pl. 100. Tessons, Büyükkaya⁹⁸.

⁹⁶BAYBURTLUOĞLU, 1976, Res. 4-7.

⁹⁷SEEHER, 1995, Abb. 20-22.

⁹⁸SEEHER, 1995, Abb. 24.



Pl. 101. Pichets, jarres, Büyükkaya⁹⁹.

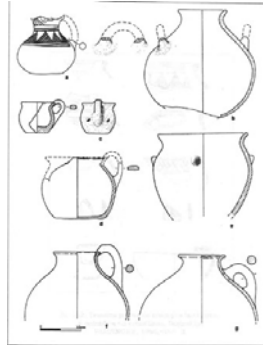

Pl. 102. Céramique, Boğazköy¹⁰⁰.



Pl. 103. Céramique peinte, Boğazköy¹⁰¹.

⁹⁹ SEEHER, 1995, Abb. 19.

¹⁰⁰ PARZINGER, 1995, Abb.2.

¹⁰¹ PARZINGER, 1995, Abb. 1.

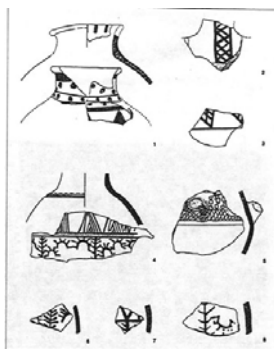

Pl. 104. Vase non tourné, Kuşaklı¹⁰².

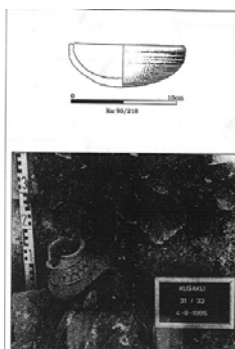

Pl. 105. Bols carénés, Gordion¹⁰³.

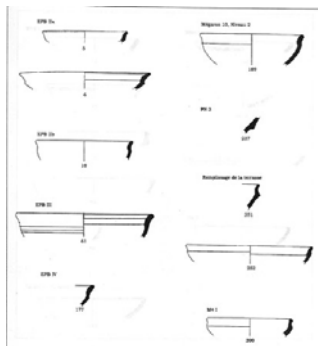

Pl. 106. Bols simples, Gordion¹⁰⁴.

¹⁰² MÜLLER-KARPE, 1996, Abb. 14-16.

¹⁰³ SAMS, 1994a, fig. 1.

¹⁰⁴ SAMS, 1994a, fig. 2.

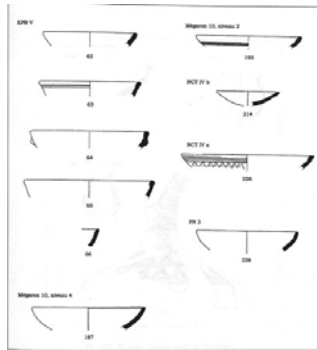

Pl. 107. Bassin et pichets, Gordion¹⁰⁵.

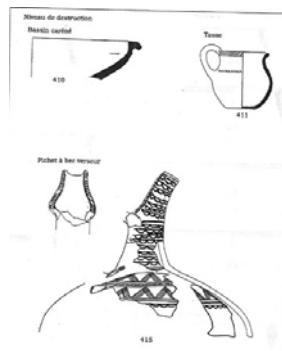

Pl. 108. Vases fermés, Groupe 1, Gordion¹⁰⁶.

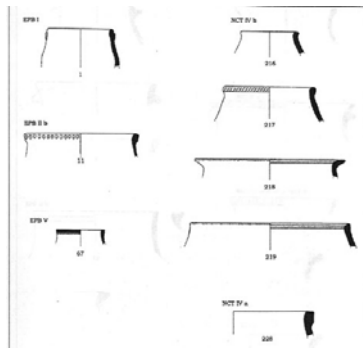

Pl. 109. Vases fermés, Groupe 2, Gordion¹⁰⁷.

¹⁰⁵ SAMS, 1994a, fig. 5.

¹⁰⁶ SAMS, 1994a, fig. 3.

¹⁰⁷ SAMS, 1994a, fig. 4.

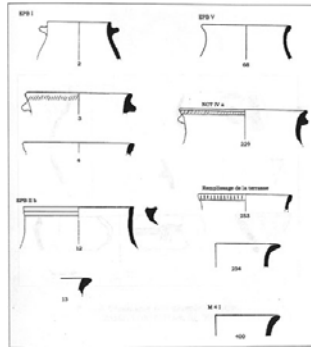

Pl. 110. Céramique non-tournée, Gordion¹⁰⁸.

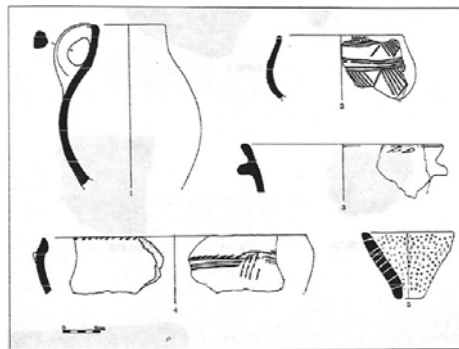

Pl. 111. Vases fermés non-tournés, Groupe 1, Gordion¹⁰⁹.

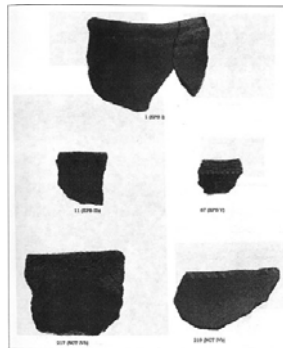

Pl. 112. Vases fermés non-tournés, Groupe 2, Gordion¹¹⁰.

¹⁰⁸ SAMS, VOIGT, 1989, fig. 20.

¹⁰⁹ SAMS, 1994a, Pl. 4

¹¹⁰ SAMS, 1994a, Pl. 6.

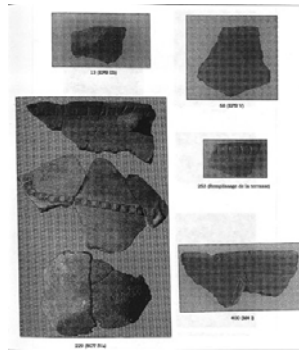

Pl. 113. Vases fermés non-tournés, Gordion¹¹¹.

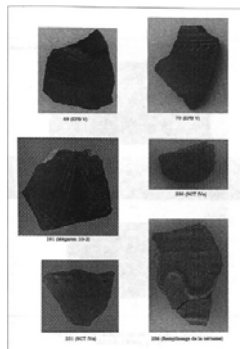

Pl. 114. Bols carénés incisés et à pied, Gordion¹¹².

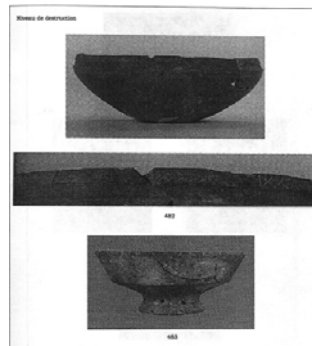

Pl. 115. *Fine-Line Buff*, Gordion¹¹³.

¹¹¹ SAMS, 1994a, pl. 7.

¹¹² SAMS, 1994a, pl. 23.

¹¹³ SAMS, 1994a, pl. 37.

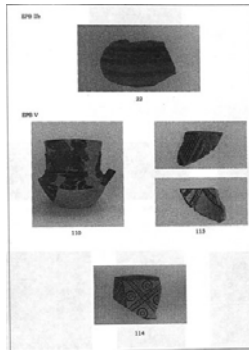

Pl. 116. Groupe de la *Polychrome House*, Gordion¹¹⁴.

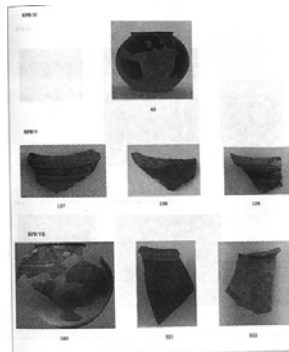

Pl. 117. *Ladders and Zigzags*, Gordion¹¹⁵.

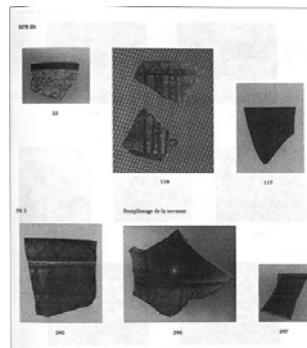

Pl. 118. *Wavy-Line Style*, Gordion¹¹⁶.

¹¹⁴ SAMS, 1994a, pl. 135.

¹¹⁵ SAMS, 1994a, Pl. 56.

¹¹⁶ SAMS, 1994a, pl. 50.

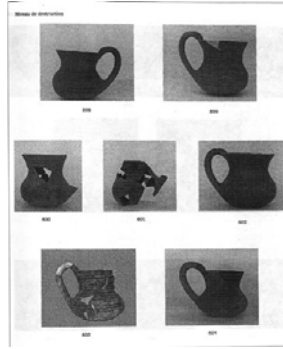

Pl. 119. *Wavy-Line* et *Chevron-Triangle*, Gordion¹¹⁷.

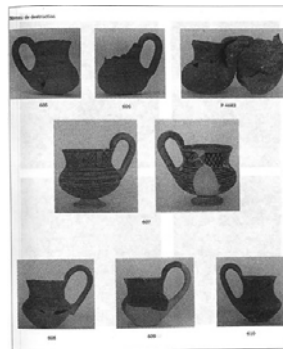

Pl. 120. *Brown-on-Buff*, Gordion¹¹⁸.



Pl. 121. Motifs imprimés, Gordion¹¹⁹.

¹¹⁷ SAMS, 1994a, pl. 51.

¹¹⁸ SAMS, 1994a, pl. 97.

¹¹⁹ SAMS, 1994a, fig. 60.

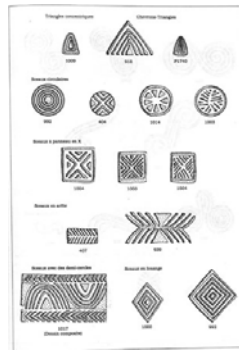

Pl. 122. Motifs imprimés, Gordion¹²⁰.

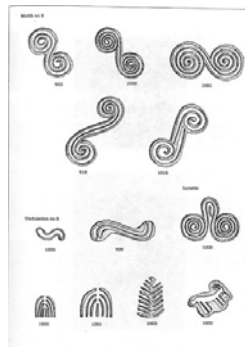

Pl. 123. Jarres à bec, Gordion¹²¹.

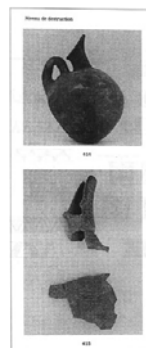

Pl. 124. Motifs peints, Gordion¹²².

¹²⁰ SAMS, 1994a, fig. 61.

¹²¹ SAMS, 1994a, pl. 9.

¹²² SAMS, 1994a, fig. 62-63.

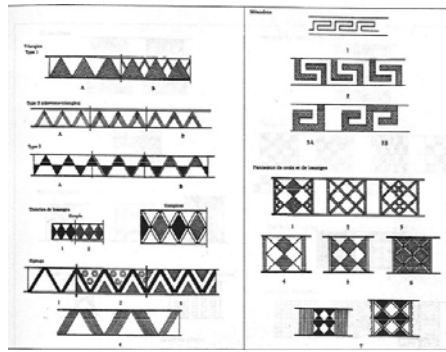

Pl. 125. Motifs peints, Gordion¹²³.

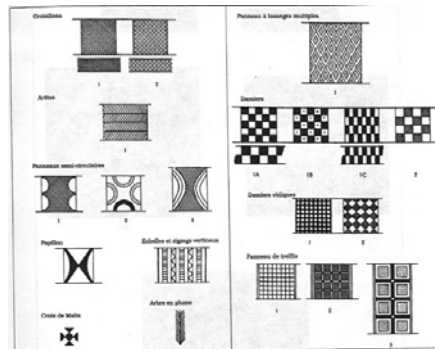

Pl. 126. *Wavy-Line* et *Fine-Line Buff Ware*, Gordion¹²⁴.

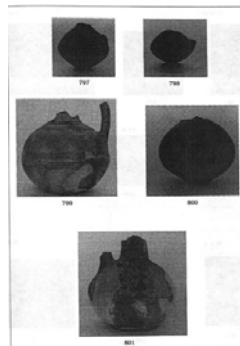

Pl. 127. *Fine-Line Buff Ware*, *Brown-on-Buff ware*, Gordion¹²⁵.

¹²³ SAMS, 1994a, fig. 64-65.

¹²⁴ SAMS, 1994a, pl. 90.

¹²⁵ SAMS, 1994a, pl. 158.

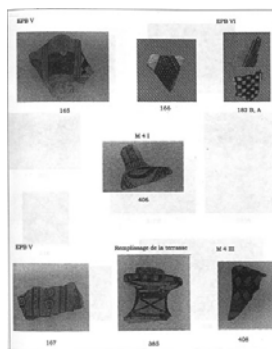

Pl. 128. Ladders-and-Zigzags, Gordion¹²⁶.

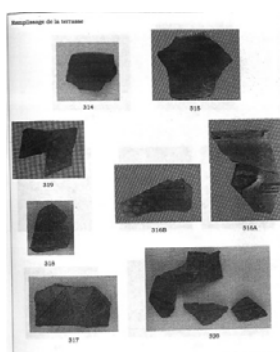

Pl. 129. Cratères-Kanthares, Gordion¹²⁷.

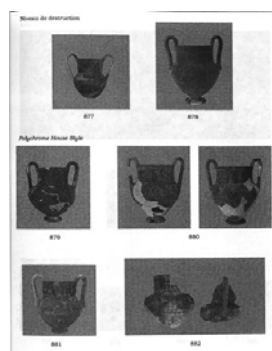

Pl. 130. Amphores à col étroit et décor de type Alişar, Gordion¹²⁸.

¹²⁶ SAMS, 1994a, pl. 117.

¹²⁷ SAMS, 1994a, pl. 110.

¹²⁸ SAMS, 1994a, pl. 113.

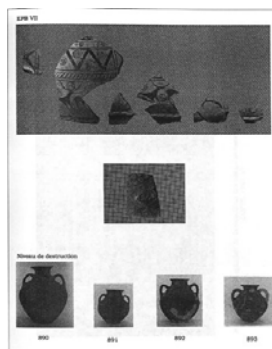

Pl. 131. Tableau récapitulatif de la répartition des catégories dans la production du niveau IV, Porsuk¹²⁹.

Catégories		Ex		Pourcentages	
Unica (33)	Cooking ware	1		1,02%	33,67%
	Céramique orange	21		21,42%	
	Céramique à enduit blanc	7		7,14%	
	Céramique à enduit rouge	4		4,08%	
Vases (65)	Céramique à décor monochrome	Sur fond orange	24	24,48%	44,89%
		Sur enduit blanc	17	17,34%	
		Sur enduit rouge	3	3,06%	
	Céramique à décor bichrome	Sur fond orange	13	13,26%	18,36%
		Sur enduit blanc	5	5,10%	
	Céramique à décor trichrome	Sur fond orange	2	2,04%	3,06%
		Sur enduit blanc	1	1,02%	
Total		98			

Pl. 132. Tableau récapitulatif de la répartition des formes dans la production du niveau IV, Porsuk¹³⁰.

Catégories		Ex		Pourcentages	
Vases Ouverts (12)	Petits bols hémisphériques	3		3,22%	45,16%
	Petits bols carénés	4		4,30%	
	Grands bols à bord épais	11		11,82%	
	Grands bols à lèvre épaisse	22		23,55%	
	Bols profonds	2		2,15%	
Vases fermés (50)	Tasses	12		12,90%	53,76%
	Grands pots	4		4,30%	
	Jarres à col tronconique	7		7,32%	
	Jarres à col cylindrique	18		18,12%	
	Jarres à épaule convexe	12		12,90%	
Divers (1)	Vase aconorhpie	1		1,02%	
Total		93			

Pl. 133. Tableau synoptique des motifs peints, Porsuk¹³¹.

¹²⁹ DUPRE, 1983, 59.

¹³⁰ DUPRE, 1983, 64.

¹³¹ DUPRE, 1983, pl. 101.

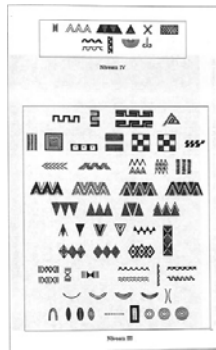

Pl. 134. Tableau récapitulatif de la répartition des catégories dans la production du niveau III, Porsuk¹³².

	Catégories	Nx	Pourcentages	
Ustens (104)	Cooking ware	19	6,98%	38,23%
	Céramique jaunâtre	31	11,39%	
	Céramique orange	32	11,76%	
	Céramique à enduit blanc	11	4,04%	
	Céramique à engobe jaune	11	4,04%	
Peintés (62)	Céramique à décor monochrome	43	15,80%	66,32%
	Sur fond orange	15	5,51%	
	Sur engobe blanc	9	3,20%	
	Sur engobe jaune	89	32,72%	
	Céramique à décor bichrome	3	1,10%	
	Sur engobe chamois	2	0,73%	
	Sur fond orange	2	0,73%	
Inscrites (7)	Céramique grise ou noire lissée	2	0,73%	2,57%
	Céramique Black-on-Red	4	1,47%	
	Céramique rhodienne	1	0,36%	
Total		272		

Pl. 135. Tableau récapitulatif de la répartition des formes dans la production du niveau III, Porsuk¹³³.

	Catégories	Nx	Pourcentages	
Vases Ouverts (52)	Bols à bord épais	26	11,13%	65,23%
	Bols à lèvre saillante	44	18,88%	
	Bols carreaux	16	6,86%	
	Bols à lèvre élargie	11	4,72%	
	Bols à lèvre ovale	10	4,29%	
	Bols à colserette	10	4,29%	
	Assiettes	18	7,72%	
	Jattes	17	7,20%	
	Vases Fermés (75)	Tasses ou cruches	14	
Vases à parois sphériques		10	6,86%	
Vases à col cylindrique		9	3,43%	
Vases à col cannelé		5	2,14%	
Cruches à bec pointu		8	3,43%	
Cooking pots		19	8,10%	
Cratères		5	3,63%	
Grands pithos		1	0,40%	
Divers (2)	Trépied	1	0,42%	0,84%
	Vase monochrome	1	0,42%	
Total		233		

Pl. 136. Tableau récapitulatif de la répartition des motifs peints du niveau III, Porsuk¹³⁴.

¹³² DUPRE, 1983, 84.

¹³³ DUPRE, 1983, 94.

¹³⁴ DUPRE, 1983, 107.

	Motif	Exemplaires	Pourcentages	
DÉCORATIONS (11%)	Orléans	2	1,23%	96,29%
	Méandre	5	5,59%	
	Échelle	1	0,61%	
	Carrés concentriques	1	0,61%	
	Carrés pointés	6	3,70%	
	Quadrilobe	8	4,93%	
	Damier	4	2,46%	
	Chevron	2	1,23%	
	Méandre fleuri	3	1,85%	
	Zigzag	16	9,87%	
	Triangle	12	7,49%	
	Losange	4	2,46%	
	Croix Saint-André	1	0,61%	
	Défilé	19	11,72%	
	Ligne ondulée	1	0,61%	
	Clous creux	1	0,61%	
Figurales (1%)	Fleur	37	22,83%	
	Ligulette	4	2,46%	
	Médaillon hexagone	3	1,85%	
	Boule de pointa	10	6,17%	
	Cercles concentriques	9	5,59%	
Total		162		

Pl. 137. Bols simples de type I, Gordion¹³⁵.

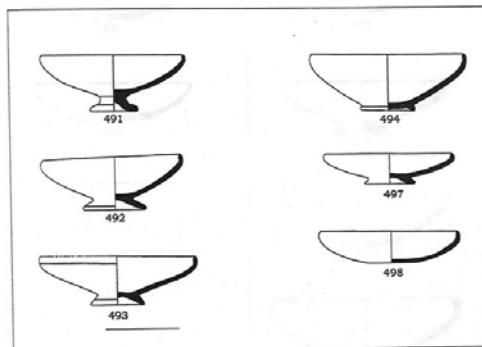

Pl. 138. Bols simples de types II et III, Gordion¹³⁶.

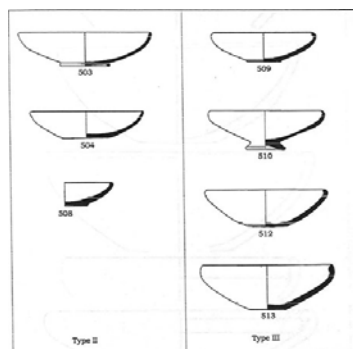

Pl. 139. Bols simples, Kaman Kalehöyük¹³⁷.

¹³⁵ SAMS, 1994a, fig. 19.

¹³⁶ SAMS, 1994a, fig. 20.

¹³⁷ OMURA, 1992, fig. 8. 2-7.

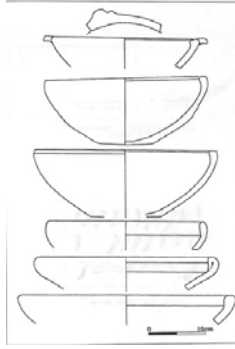

Pl. 140. Bols, Pazarlı, Alişar¹³⁸.

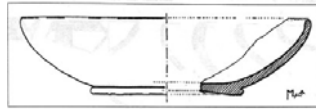

Bol simple en céramique grise, Pazarlı.
KOŞAY, 1938, 17.



Bols simples et à lèvres saillantes, échelle 1/4, Alişar.
von der OSTEN, 1937, fig. 432.

Pl. 141. Bols simples peints, Maşat Höyük¹³⁹.

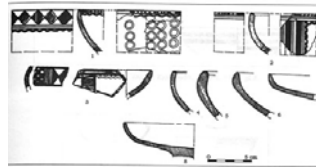

Bols simples peints, Maşat Höyük.
ÖZGÜÇ, 1982, fig. H.

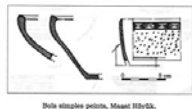

Bols simples peints, Maşat Höyük.
ÖZGÜÇ, 1982, fig. H.

Pl. 142. Bols simples peints, Kaman, Porsuk¹⁴⁰.

¹³⁸ KOŞAY, 1938, 17. von der OSTEN, 1937, fig. 432.

¹³⁹ ÖZGÜÇ, 1982, fig. H.

¹⁴⁰ OMURA, 1992, pl. 2. DUPRE, 1983, pl. 60.



Bols simple peints, Karahöyük, Omura, 1993, pl.2.



Bols simple peints, Maşat, Omura, 1993, pl.2.

Pl. 143. Bols simples, Karahöyük, Maşat, Pazarlı¹⁴¹.

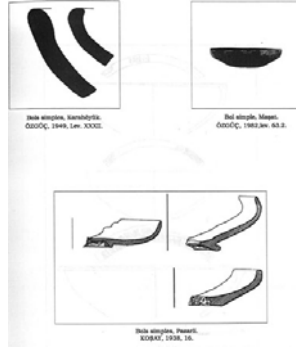

Bols simples, Karahöyük, ÖZGÜÇ, 1949, Lev. XXXII.

Bols simple, Maşat, ÖZGÜÇ, 1982, Lev. 63.2.

Bols simples, Pazarlı, KOŞAY, 1938, 16.

Pl. 144. Bols simples peints, Kaman¹⁴².

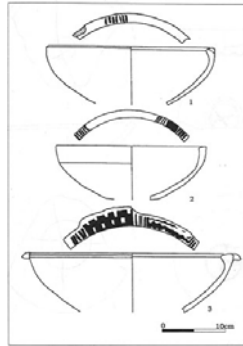

Pl. 145. Bols simples incisés, Kaman¹⁴³.

¹⁴¹ ÖZGÜÇ, 1949, Lev. XXXII ; 1982, Lev. 63. 2. KOŞAY, 1938, 16.

¹⁴² OMURA, 1993, pl. 7.

¹⁴³ OMURA, 1993, pl. 2. 4-6.

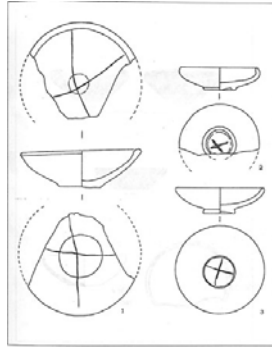

Pl. 146. Bols simples, Alişar¹⁴⁴.



Pl. 147. Bols simples, à lèvre saillante et à marli, Büyük Güllücek¹⁴⁵.

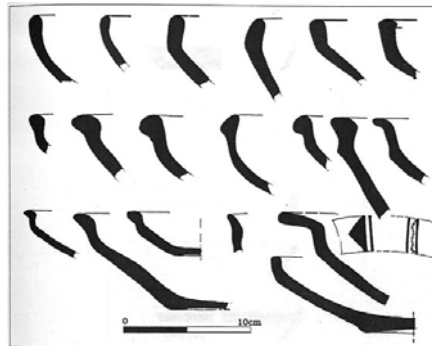

Pl. 148. Bols hémisphériques et carénés, niveau IV, Porsuk¹⁴⁶.

¹⁴⁴ von der OSTEN, 1928-29, pl. XXVIII.

¹⁴⁵ KOŞAY, 1957, Taf. IX.

¹⁴⁶ DUPRE, 1983, pl. 44.

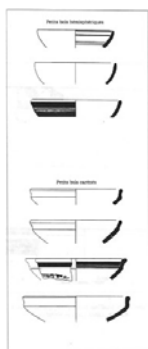

Pl. 149. Bols simples, à bord saillant et bassin, Çadir¹⁴⁷.

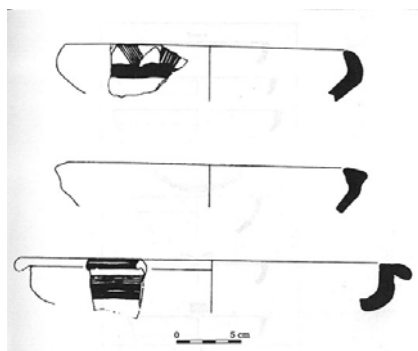

Pl. 150. Bols carénés, types a et b, Porsuk¹⁴⁸.

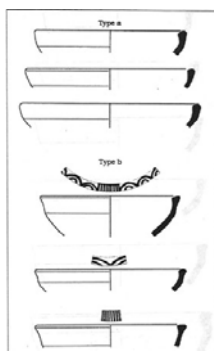

Pl. 151. Bols carénés de type b, Porsuk¹⁴⁹.

¹⁴⁷ GORNY *et alii.*, 1995, fig. 19.

¹⁴⁸ DUPRE, 1983, pl. 69.

¹⁴⁹ DUPRE, 1983, pl. 70.

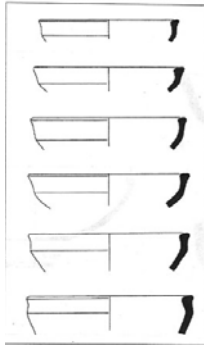

Pl. 152. Bols carénés à bord évasé ou droit, Karahöyük¹⁵⁰.

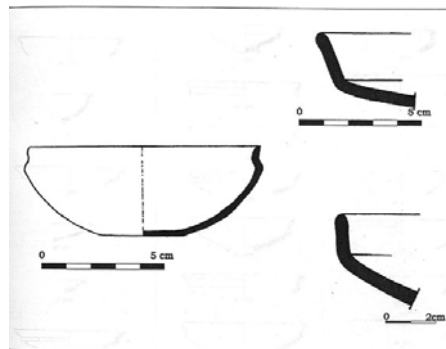

Pl. 153. Bols carénés de types I, II et III, Gordion¹⁵¹.

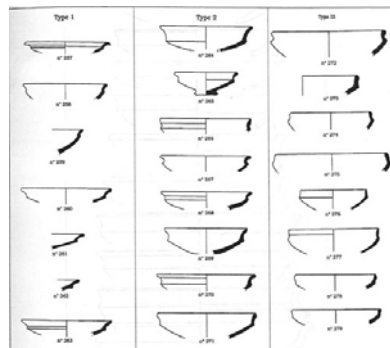

Pl. 154. Bols carénés, Kaman¹⁵².

¹⁵⁰ ÖZGÜÇ, 1949, Lev. XI.

¹⁵¹ SAMS, 1994a, fig. 10.

¹⁵² OMURA, 1992, fig. 10.

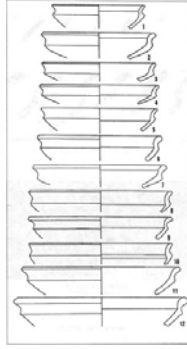

Pl. 155. Bols carénés, Alishar, Karahöyük¹⁵³.

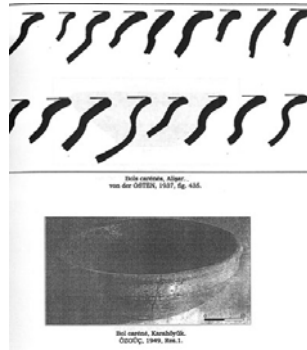

Pl. 156. Bols carénés, Alishar, Maşat Höyük¹⁵⁴.



Pl. 157. Bols carénés peints, Kaman Kalehöyük¹⁵⁵.

¹⁵³ von der OSTEN, 1937, fig. 435. ÖZGÜÇ, 1949, Res. 1.

¹⁵⁴ von der OSTEN, 1928-29, fig. 55. ÖZGÜÇ, 1982, pl. 63.

¹⁵⁵ OMURA, 1992, fig. 9.



Pl. 158. Bols carénés, Pazarlı¹⁵⁶.

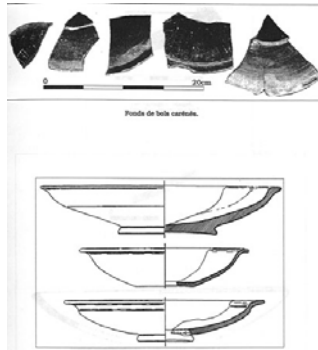

Pl. 159. Bols coniques¹⁵⁷.

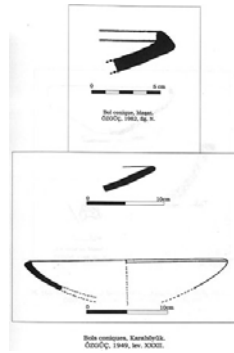

Pl. 160. Bols coniques à bord droit ou saillant, Karahöyük, Maşat¹⁵⁸.

¹⁵⁶ KOŞAY, 1938, 17.

¹⁵⁷ ÖZGÜÇ, 1982, fig. N. ÖZGÜÇ, 1949, Lev. XXXII.

¹⁵⁸ ÖZGÜÇ, 1949, Lev. XI. ÖZGÜÇ, 1982, fig. H.

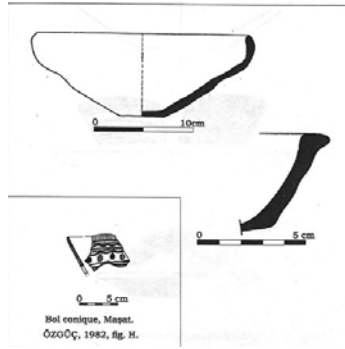

Pl. 161. Bols coniques, Kaman¹⁵⁹.

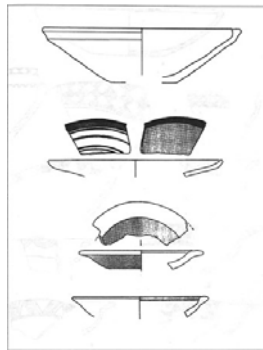

Pl. 162. Bols simples et à marli, Büyükkaya¹⁶⁰.



Pl. 163. Bols à marli, Alişar, Maşat¹⁶¹.

¹⁵⁹ OMURA, 1993, pl. 1. 1-4.

¹⁶⁰ SEEHER, 1995, Abb. 23.

¹⁶¹ von der OSTEN, 1937, fig. 434-435. ÖZGÜÇ, 1982, pl. 63.



Pl. 164. Bol caréné à marli, Kaman¹⁶².

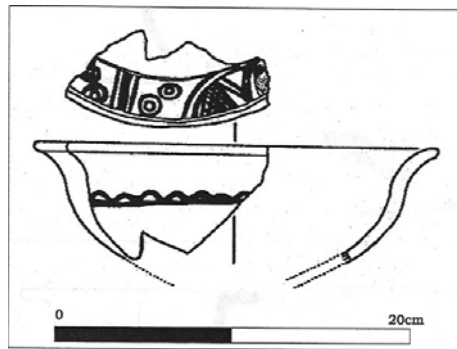

Pl. 165. Bols à marli, Aktepe, Çadir¹⁶³.

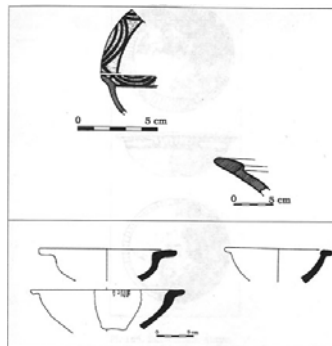

Pl. 166. Bol à marli, Alişar¹⁶⁴.

¹⁶² OMURA, 1995, fig. 19.

¹⁶³ ÖZGÜÇ, 1978, 103. GORNY *et alii.*, 1995, fig. 19.

¹⁶⁴ von der OSTEN, 1937, fig. 404.



Pl. 167. Bols à marli, Karahöyük¹⁶⁵.

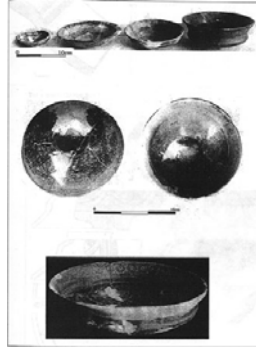

Pl. 168. Bols à marli, Kültepe, Göllüdağ¹⁶⁶.

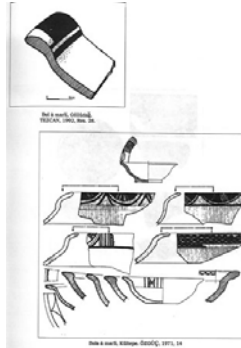

Pl. 169. Bols à marli, Kültepe¹⁶⁷.

¹⁶⁵ ÖZGÜÇ, 1949, Lev. XIV.

¹⁶⁶ TEZCAN, 1992, Res. 28. ÖZGÜÇ, 1971, 14.

¹⁶⁷ ÖZGÜÇ, 1971, pl. XIV.

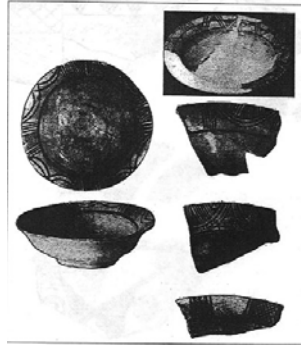

Pl. 170. Bols à marli, Kayapınar¹⁶⁸.

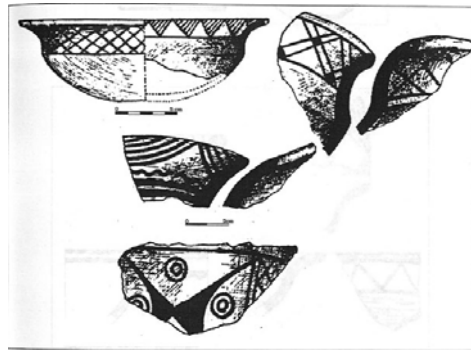

Pl. 171. Bols à marli, Maşat Hüyük¹⁶⁹.

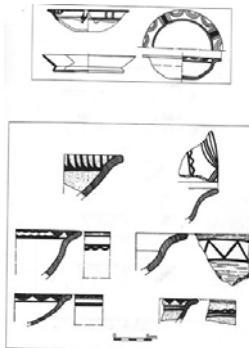

Pl. 172. Bols à marli, série 1 et 2, Porsuk¹⁷⁰.

¹⁶⁸ TEMIZER, 1954, Resim 2.

¹⁶⁹ ÖZGÜÇ, 1982, fig. H.

¹⁷⁰ DUPRE, 1983, pl. 72.

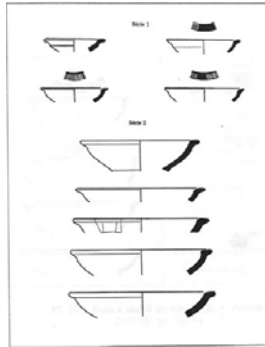

Pl. 173. Bols à marli, série 3 et 4, Porsuk¹⁷¹.

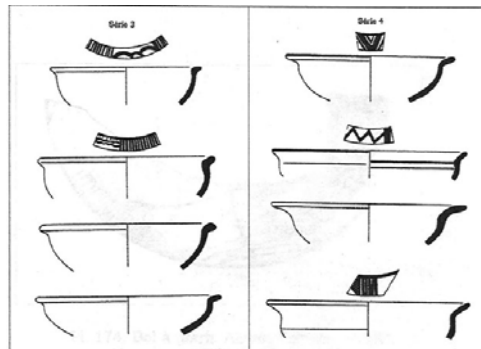

Pl. 174. Bols à marli, Alişar¹⁷².

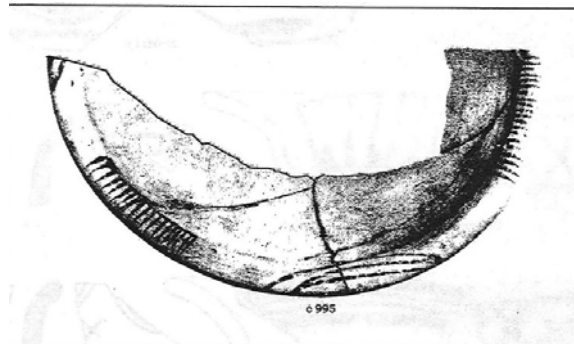

Pl. 175. Décors peints de bols à marli, Alişar¹⁷³.

¹⁷¹ DUPRE, 1983, pl. 73-74.

¹⁷² von der OSTEN, 1937, fig. 405.

¹⁷³ von der OSTEN, 1928-29, pl. XXXI.

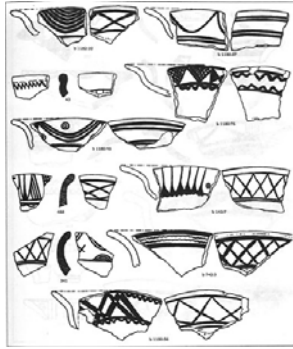

Pl. 176. Décors peints de bols à marli, Alişar¹⁷⁴.



Pl. 177. Bols à marli, Alişar, Pazarlı¹⁷⁵.

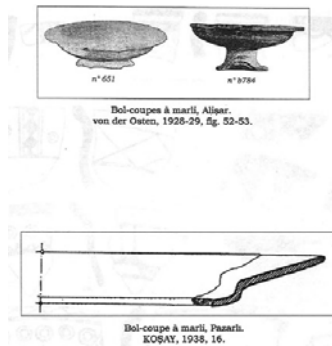

Pl. 178. Décors peints sur des bols à lèvre saillante, simple et à marli, Alişar¹⁷⁶.

¹⁷⁴ von der OSTEN, 1928-29, pl. XXXII.

¹⁷⁵ von der OSTEN, 1928-29, fig. 52-53. KOŞAY, 1938, 16.

¹⁷⁶ von der OSTEN, 1930, pl. XXX.



Pl. 179. Bols à marli et à lèvre saillante gris, Alişar¹⁷⁷.

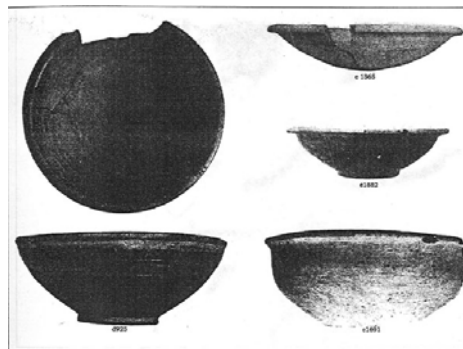

Pl. 180. Bols simples et à marli, Karahöyük¹⁷⁸.

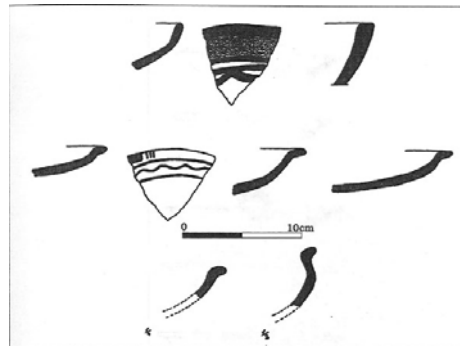

Pl. 181. Bols-assiettes à marli, Porsuk¹⁷⁹.

¹⁷⁷ von der OSTEN, 1937, 356.

¹⁷⁸ ÖZGÜÇ, 1949, Lev. XXIII.

¹⁷⁹ DUPRE, 1983, pl. 77.

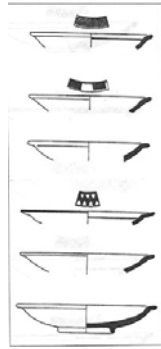

Pl. 182. Bols-Assiettes à marli, Porsuk¹⁸⁰.



Pl. 183. Bols coniques, jattes, Porsuk¹⁸¹.

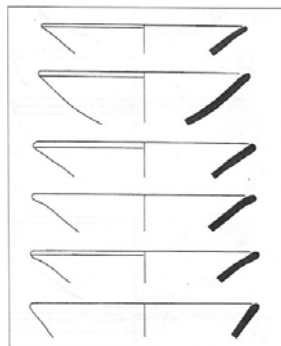

Pl. 184. Bols à lèvre saillante, Kaman Kalehöyük¹⁸².

¹⁸⁰ DUPRE, 1983, pl. 78.

¹⁸¹ DUPRE, 1983, pl. 80.

¹⁸² OMURA, 1992, pl. 6.

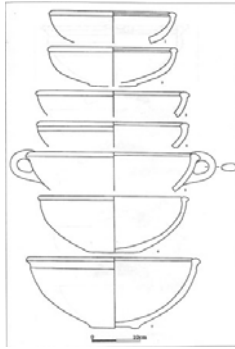

Pl. 185. Bols à lèvre saillante, Kaman¹⁸³.



Pl. 186. Bols à lèvre saillante de type a, Porsuk¹⁸⁴.

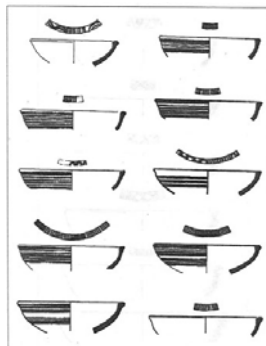

Pl. 187. Bols à bord saillant de type b, Porsuk¹⁸⁵.

¹⁸³ OMURA, 1993, pl. 6, 40.

¹⁸⁴ DUPRE, 1983, pl. 63.

¹⁸⁵ DUPRE, 1983, pl. 61.

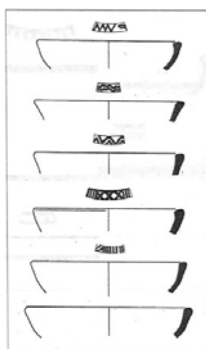

Pl. 188. Grands bols à lèvre épaisse, série a, niveau IV, Porsuk¹⁸⁶.



Pl. 189. Grands bols à bord épaissi, série a et b, niveau IV, Porsuk¹⁸⁷.

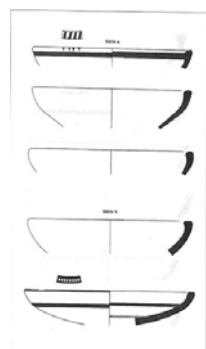

Pl. 190. Grands bols à bord épaissi, série a et b, niveau IV, Porsuk¹⁸⁸.

¹⁸⁶ DUPRE, 1983, pl. 47.

¹⁸⁷ DUPRE, 1983, pl. 46.

¹⁸⁸ DUPRE, 1983, pl. 48.

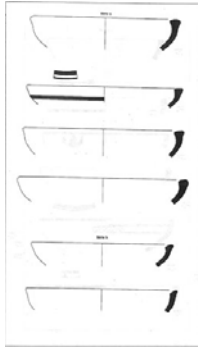

Pl. 191. Grands bols à bord épaissie, série a, niveau IV, Porsuk¹⁸⁹.



Pl. 192. Bols à lèvre saillante, Karahöyük, Maşat Höyük¹⁹⁰.

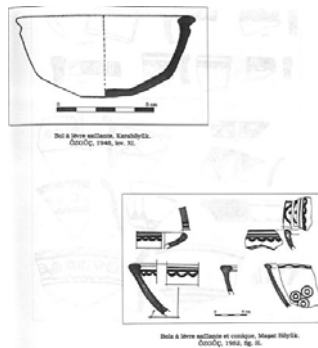

Pl. 193. Décors peints sur des bols à lèvre saillante, simple et évasée, Alişar¹⁹¹.

¹⁸⁹ DUPRE, 1983, pl. 45.

¹⁹⁰ ÖZGÜÇ, 1948, Lev. XI. ÖZGÜÇ, 1982, fig. H.

¹⁹¹ von der OSTEN, 1930, pl. XXX.



Pl. 194. Bols à lèvre saillante et à marli peintes, Alişar¹⁹².



Pl. 195. Bols simples et à bord saillant, Kültepe et Alişar¹⁹³.

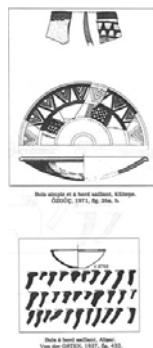

Pl. 196. Bols à lèvre saillante, Kültepe¹⁹⁴.

¹⁹² von der OSTEN, 1937, 353.

¹⁹³ ÖZGÜÇ, 1971, fig. 26a, b. von der OSTEN, 1937, fig. 432.

¹⁹⁴ ÖZGÜÇ, 1971, 14.

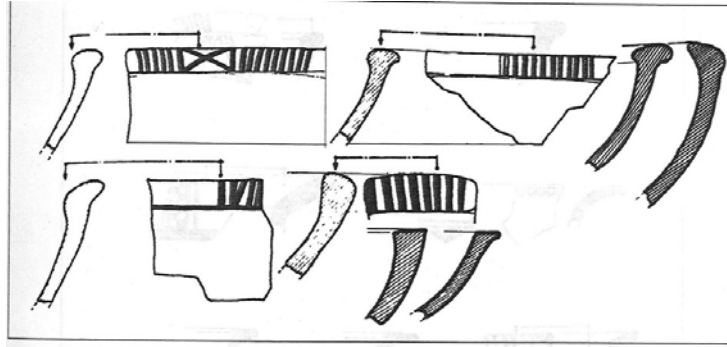

Pl. 197. Bols à lèvres saillante et à marli, Kululu¹⁹⁵.



Pl. 198. Bols à lèvres saillante, Gordion¹⁹⁶.

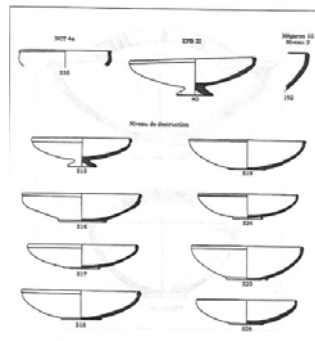

Pl. 199. Bols à lèvres saillante, Göllüdağ¹⁹⁷.

¹⁹⁵ ÖZGÜÇ, 1971, 40.

¹⁹⁶ SAMS, 1994a, fig. 21.

¹⁹⁷ TEZCAN, 1992, Res. 25-27.

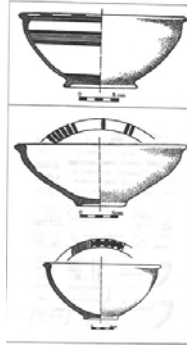

Pl. 200. Décors peints de bols, Alişar¹⁹⁸.

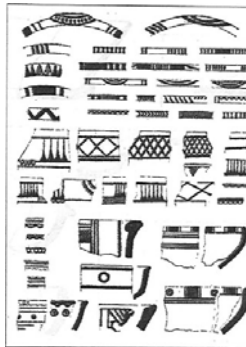

Pl. 201. Bols à marli, lèvre saillante et collerette, Pazarlı¹⁹⁹.

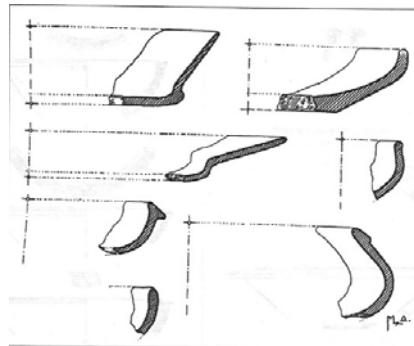

Pl. 202. Bols à collerette, Porsuk, Alişar, Kaman²⁰⁰.

¹⁹⁸ von der OSTEN, 1937, fig. 433.

¹⁹⁹ KOŞAY, 1938, 16.

²⁰⁰ DUPRE, 1983, pl. 75. von der OSTEN, 1937, fig. 432. OMURA, 1992, fig. 9.

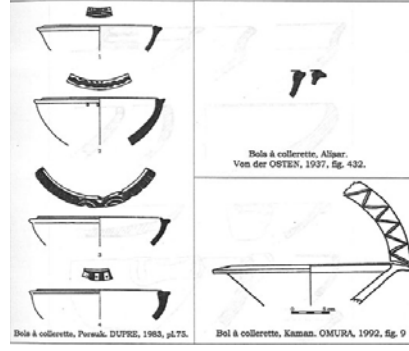

Pl. 203. Bols simples, carénés, coniques, Küçük Höyük²⁰¹.

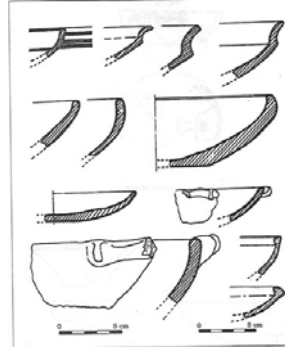

Pl. 204. Bols, Kaman²⁰².

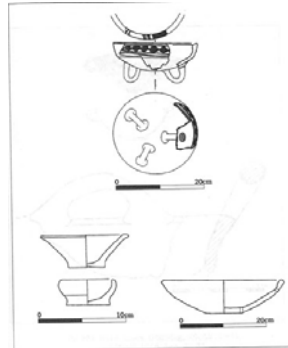

Pl. 205. Bol à anses, Göllüdağ, Küçük Höyük²⁰³.

²⁰¹ ÖZKAN, 1990, fig. 23-32, 39-40.

²⁰² OMURA, 1995, fig. 19.

²⁰³ TEZCAN, 1968, Res. 32-33. ÖZKAN, 1990, fig. 38.

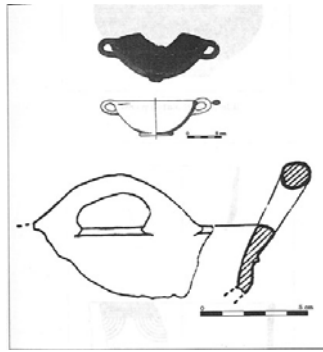

Pl. 206. Gobelets, Alişar, Porsuk²⁰⁴.



Pl. 207. Tasses à col haut évasé et à col bas, Gordion²⁰⁵.

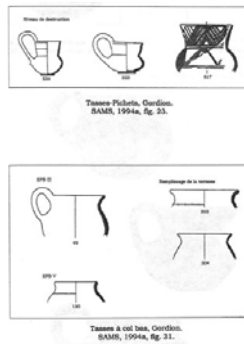

Pl. 208. Tasses à col bas, grossières, Hacibektaş, Alişar²⁰⁶.

²⁰⁴ von der OSTEN, 1928-29, pl. I. DUPRE, 1983, pl. 50.

²⁰⁵ SAMS, 1994a, fig. 23, 31.

²⁰⁶ BALKAN, SÜMER, 1969, Resim 17-20. von der OSTEN, 1937, fig. 408.



Pl. 209. Tasses à col bas, Sultanhan, Alişar²⁰⁷.

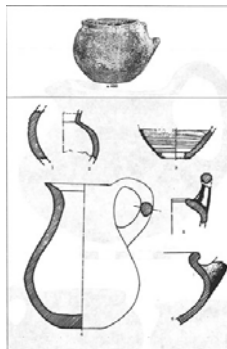

Pl. 210. Tasses à embouchure trilobée et à col bas, Kayapınar²⁰⁸.

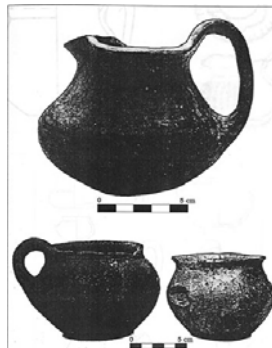

Pl. 211. Tasses à col bas, trilobé et bec latéral, Kaman²⁰⁹.

²⁰⁷ EMRE, 1971, fig. 89-91, 93-95. von der OSTEN, 1928-29, 50, fig. 61.

²⁰⁸ TEMIZER, 1954, Resim 5-6.

²⁰⁹ OMURA, 1992, fig. 13.1-2 ; 1993, fig. 10. 3-4.

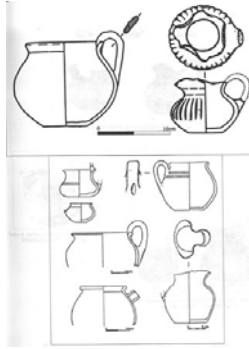

Pl. 212. Pichets-Tasses à embouchure trilobée, Boğazköy²¹⁰.

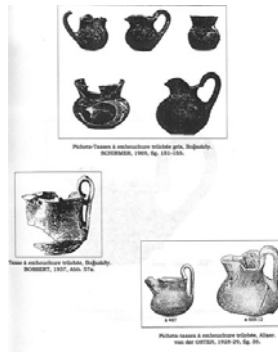

Pl. 213. Tasse à embouchure trilobée, Kayapınar²¹¹.

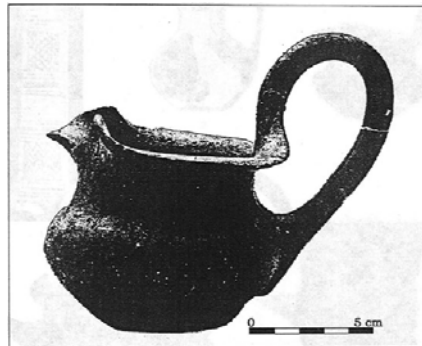

Pl. 214. Pichets et tasses à embouchure trilobée, Kültepe²¹².

²¹⁰ SCHIRMER, 1969, fig. 151-155. BOSSERT, 1957, Abb. 57a. von der OSTEN, 1928-29, fig. 56.

²¹¹ TEMIZER, 1954, Resim 4.

²¹² ÖZGÜÇ, 1971, pl. XVI.



Pl. 215. Tasses à embouchure trilobée, Konya²¹³.



Pl. 216. Tasses à col haut évasé, Alişar²¹⁴.



Pl. 217. Tasses à col haut, Çalapverdi, Alişar²¹⁵.

²¹³ ALP, 1976, 328 a-b.

²¹⁴ von der OSTEN, 1937, fig. 409.

²¹⁵ ÖZGÜÇ, 1971, 68, fig. 162. von der OSTEN, 1928-29, pl. I.



Pl. 218. Tasses à col haut évasé et à panse godronnée, Alişar²¹⁶.



Pl. 219. Tasses à col évasé et bas, Alişar²¹⁷.

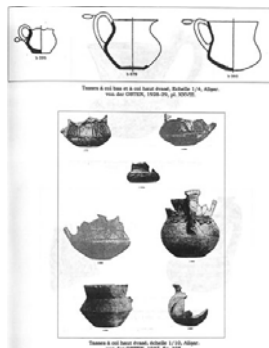

Pl. 220. Tasses à panse surbaissée et à col haut évasé, Boğazköy, Maşat Höyük²¹⁸.

²¹⁶ von der OSTEN, 1937, fig. 410.

²¹⁷ von der OSTEN, 1928-29, pl. XXVIII ; 1937, fig. 408.

²¹⁸ NEVE, 1975, 20, Abb. 8. ÖZGÜÇ, 1982, pl. 63.



Tasse à panse sphérique et col haut évasé, Mésopotamie.
REVUE, 1973, 30, Ann. 6.



Tasses à panse sphérique et col évasé, Mésopotamie.
CDOG, 1981, 40, 40.

Pl. 221. Tasses, Porsuk²¹⁹.

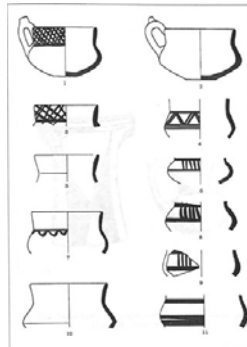

Pl. 222. Tasse à col haut évasé et détail de l'anse, Kayapınar²²⁰.

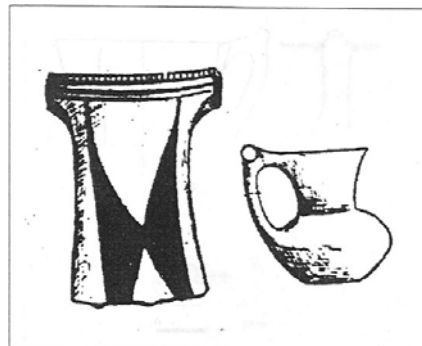

Pl. 223. Tasses à col haut et panse sphérique, Kaman²²¹.

²¹⁹ DUPRE, 1983, pl. 51.

²²⁰ TEMIZER, 1954, Resim. 2.

²²¹ MIKAMI, OMURA, 1992, fig. 9.

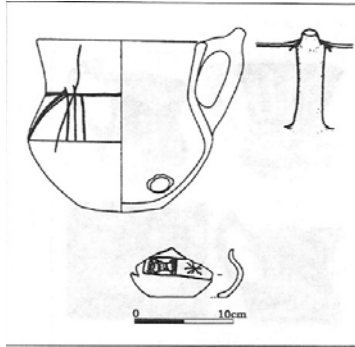

Pl. 224. Tasses, Kültepe²²².



Pl. 225. Jarre à embouchure ronde ou tasse, Kültepe²²³.



Pl. 226. Pichets-tasses à embouchure ronde et trilobée, Kültepe²²⁴.

²²² ÖZGÜÇ, 1971, fig. 100, pl. XV.

²²³ ÖZGÜÇ, 1971, pl. XXVII.

²²⁴ ÖZGÜÇ, 1971, 16.



Pl. 227. Tasses et pichets, Boğazköy, Kültepe²²⁵.



Pl. 228. Tasses et pichets peints, Gordion²²⁶.

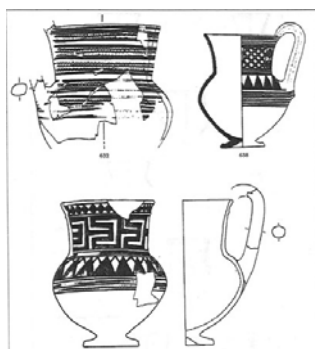

Pl. 229. Tasses-Pichets à embouchure ronde, Gordion²²⁷.

²²⁵ BOSSERT, 1957, Abb. 56b. ÖZGÜÇ, 1971, 17, fig. 56-57.

²²⁶ SAMS, 1994a, fig. 24.

²²⁷ SAMS, 1994a, fig. 22.

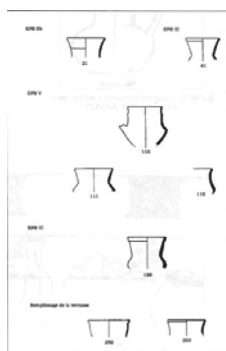

Pl. 230. Tasses, Göllüdağ, Gordion²²⁸.

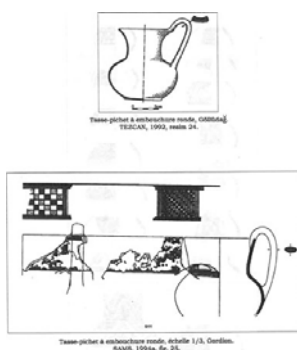

Pl. 231. Jarres à panse sphérique, séries a et b, Porsuk²²⁹.



Pl. 232. Tasses à embouchure ronde, Göllüdağ²³⁰.

²²⁸ TEZCAN, 1992, Resim 24. SAMS, 1994a, fig. 25.

²²⁹ DUPRE, 1983, pl. 83-84.

²³⁰ TEZCAN, 1992, Resim 20-22.

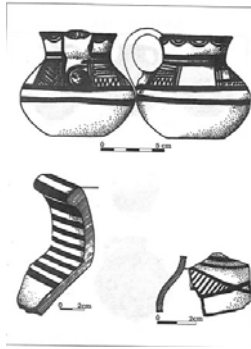

Pl. 233. Pichets à embouchure trilobée et ronde, Alişar²³¹.

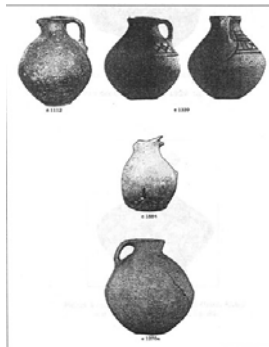

Pl. 234. Pichets à embouchure trilobée, Alişar²³².

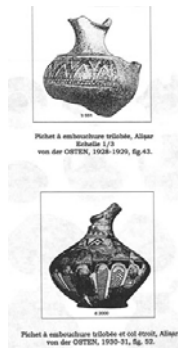

Pl. 235. Pichets à embouchure trilobée, Alişar²³³.

²³¹ von der OSTEN, 1937, fig. 416.

²³² von der OSTEN, 1928-29, fig. 43 ; 1930-31, fig. 52.

²³³ von der OSTEN, 1937, fig. 411.



Pl. 236. Pichets à embouchure trilobée, Alişar²³⁴.

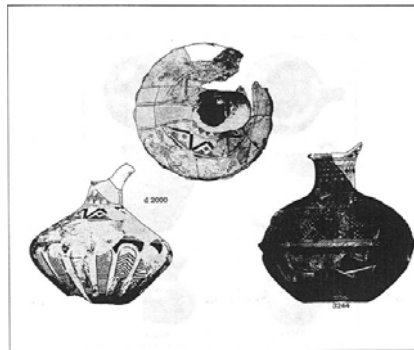

Pl. 237. Pichets à embouchure trilobée à cols étroit ou large, Alişar²³⁵.

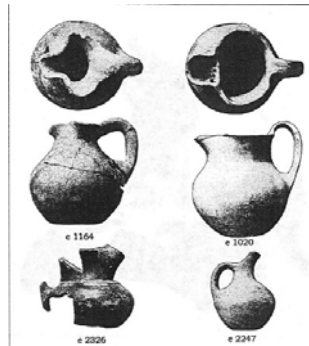

Pl. 238. Pichet à embouchure trilobée complexe, Büyükkale II²³⁶.

²³⁴ von der OSTEN, 1937, fig. 412.

²³⁵ von der OSTEN, 1937, fig. 413.

²³⁶ BOSSERT, 1957, Abb. 55.



Pl. 239. Pichets, Tasses à embouchure trilobée et ronde, Maşat²³⁷.

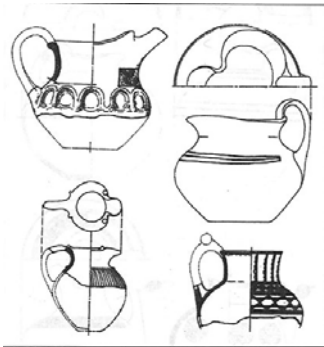

Pl. 240. Pichets à col large et embouchure trilobée, Maşat²³⁸.

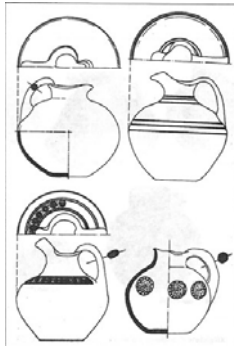

Pl. 241. Pichets à embouchure trilobée, Karahöyük²³⁹.

²³⁷ ÖZGÜÇ, 1982, fig. 124-127.

²³⁸ ÖZGÜÇ, 1982, fig. 128-131.

²³⁹ ÖZGÜÇ, 1949, Lev. XXX.



Pl. 242. Pichet à embouchure trilobée, Karahöyük²⁴⁰.



Pl. 243. Pichet à embouchure trilobée et bouteille à col étroit, Karahöyük²⁴¹.



Pl. 244. Pichets à embouchure trilobée, Karahöyük²⁴².

²⁴⁰ ÖZGÜÇ, 1949, Lev. XXII.

²⁴¹ ÖZGÜÇ, 1949, Lev. XVI.

²⁴² ÖZGÜÇ, 1949, Lev. XV.



Pl. 245. Pichets à embouchure trilobée, Sultanhan²⁴³.

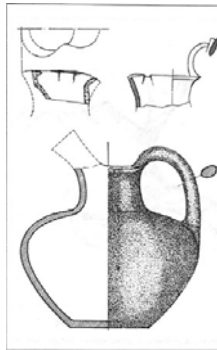

Pl. 246. Pichet à embouchure trilobée, Sultanhan²⁴⁴.

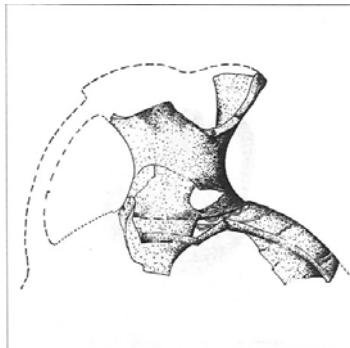

Pl. 247. Pichet à col étroit, Kayapınar²⁴⁵.

²⁴³ EMRE, 1971, fig. 25-27.

²⁴⁴ EMRE, 1971, fig. 29.

²⁴⁵ TEMIZER, 1954, Res. 3.

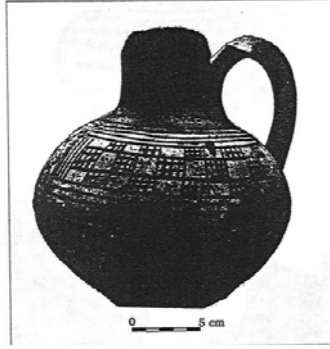

Pl. 248. Pichets à embouchure trilobée, Kültepe et Kayapınar²⁴⁶.

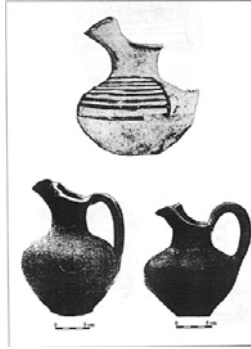

Pl. 249. Pichets à embouchure trilobée, Kültepe²⁴⁷.



Pl. 250. Pichet à embouchure trilobée, jarre à anse et embouchure ronde, tasse, Hacibektaş²⁴⁸.

²⁴⁶ ÖZGÜÇ, 1971, 2. TEMIZER, 1954, Res. 7-8.

²⁴⁷ ÖZGÜÇ, 1971, Res. 60, pl. XVIII. 1a-b.

²⁴⁸ BALKAN, SÜMER, 1967, Res. 36-38.

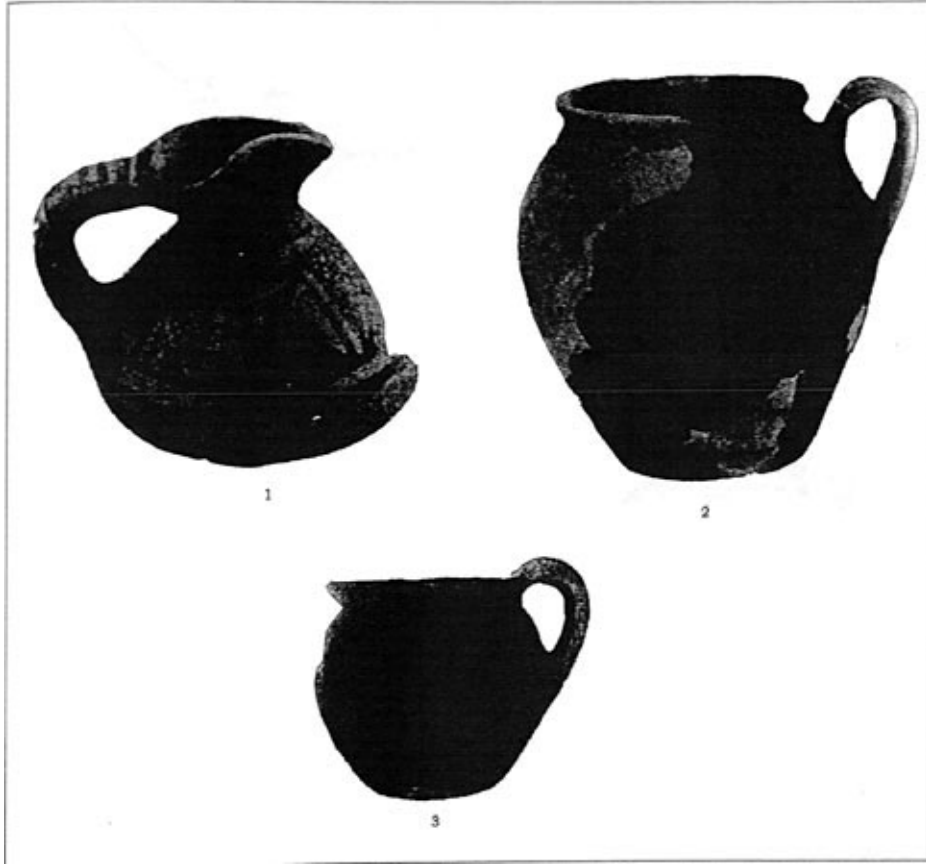

Pl. 251. Pichets à embouchure trilobée, Çalapverdi, Tepebağları, Hacibektaş²⁴⁹.

²⁴⁹ ÖZGÜÇ, 1971, fig. 165. ÇINAROĞLU, 1976, 125. BALKAN, SÜMER, 1957, 2-3.



Fichet à embouchure trilobée, Çalaperdi.
ÖZGÜÇ, 1971, fig. 165.

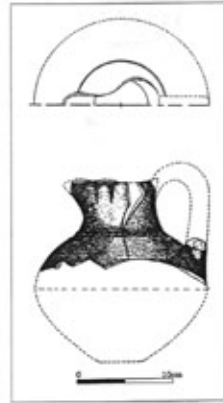

Fichet à embouchure trilobée, Tepebağlan.
ÇINAROĞLU, 1976, 125.

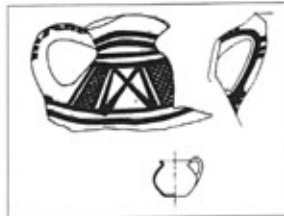

Fichet à embouchure trilobée et tasse, Hacibektaş.
BALKAN, SÜMER, 1957, 2-3.

Pl. 252. Pichets-jarres à embouchure ronde, séries a, b et c, Porsuk²⁵⁰.

²⁵⁰ DUPRE, 1983, pl. 81-82.

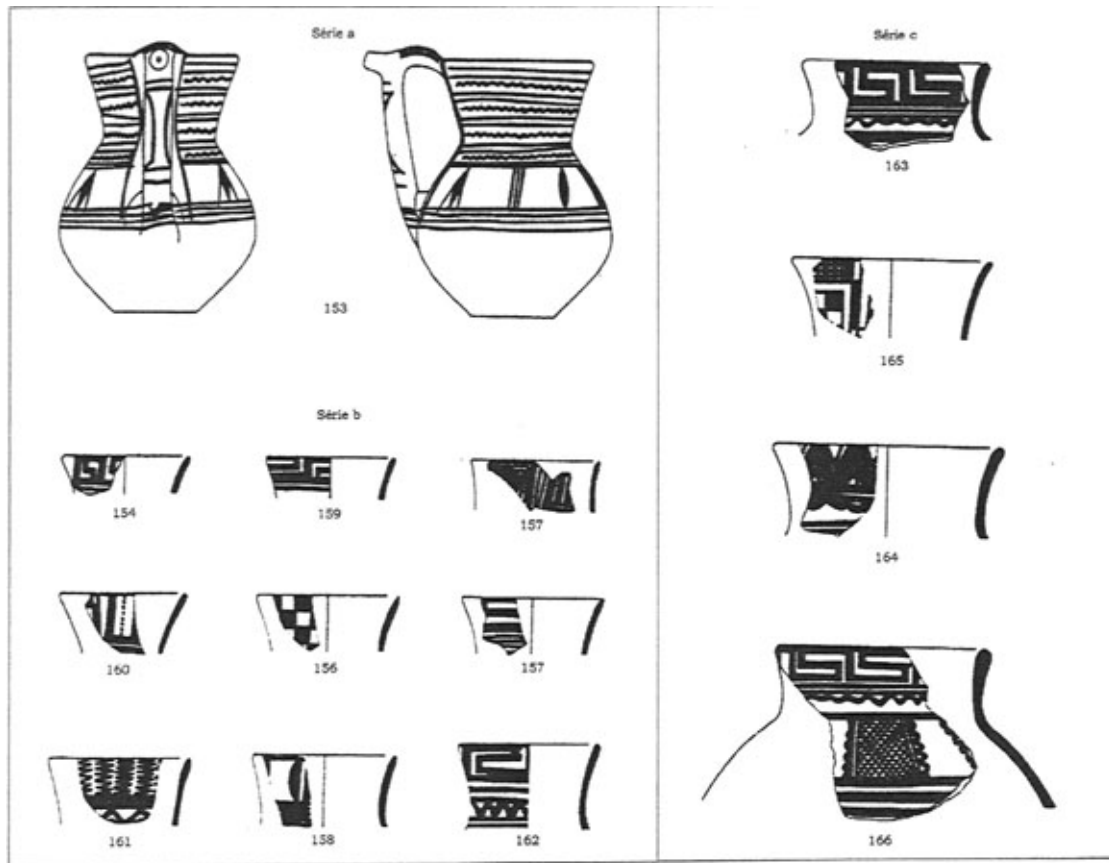

Pl. 253. Pichets à col étroit ou large et à embouchure trilobée, Gordion²⁵¹.

²⁵¹ SAMS, 1994a, fig. 26.

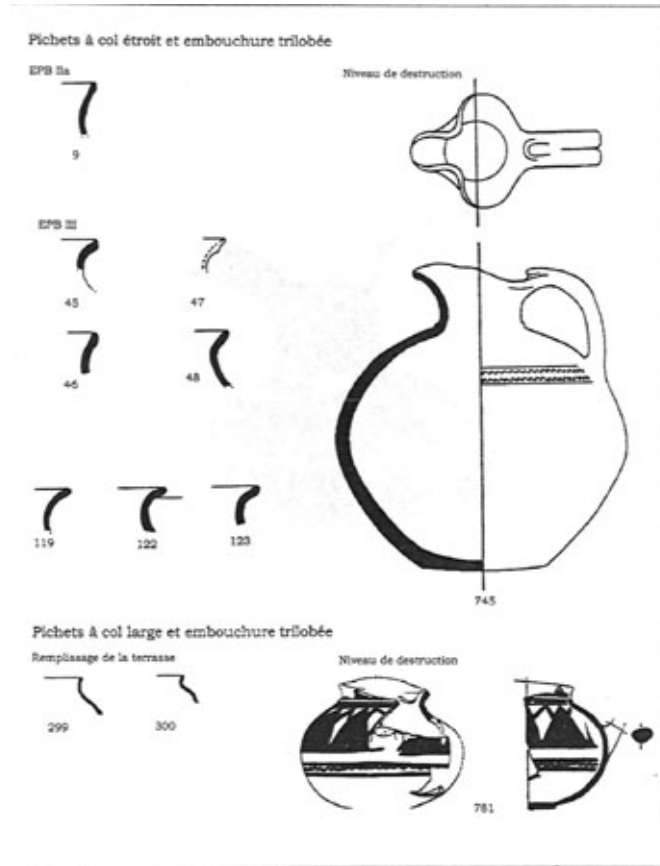

Pl. 254. Pichet à embouchure trilobée, Pazarlı²⁵².

²⁵² KOŞAY, 1938, 16.

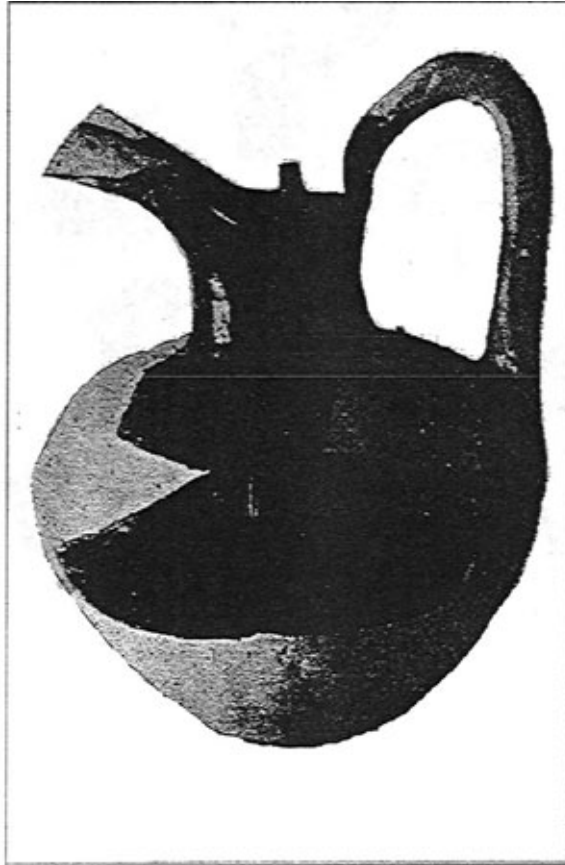

Pl. 255. Pichets à bec latéral, Alişar²⁵³.

²⁵³ von der OSTEN, 1937, fig. 415 ; 1930-31, fig. 52.

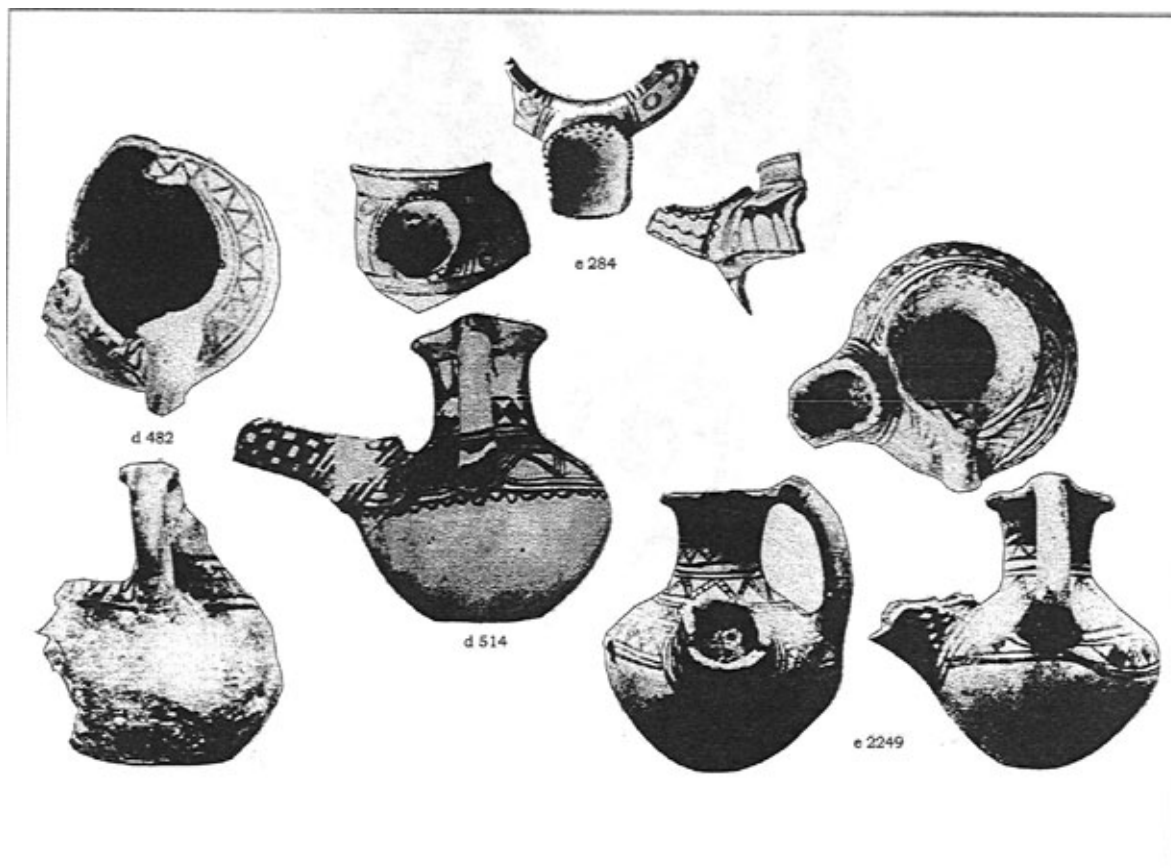

Pl. 256. Pichets à bec latéral, Alişar²⁵⁴.

²⁵⁴ von der OSTEN, 1937, fig. 414.

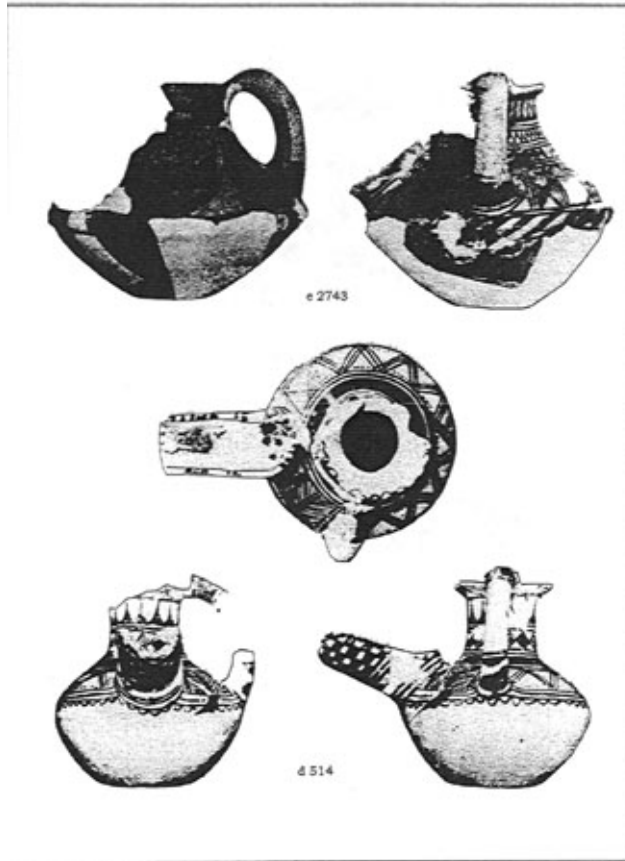

Pl. 257. Pichets à bec latéral, Hacibektaş²⁵⁵.

²⁵⁵ BALKAN, SÜMER, 1967, fig. 10. Res. 15.

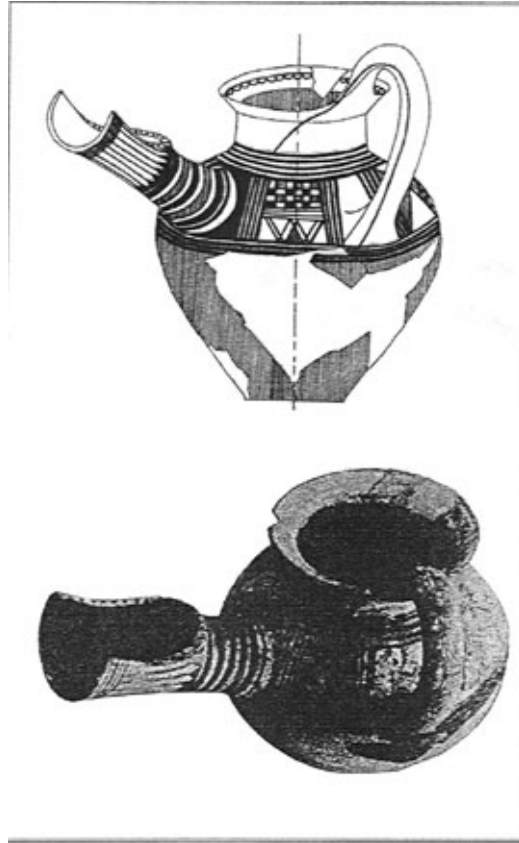

Pl. 258. Pichets à bec latéral, Maşat Höyük²⁵⁶.

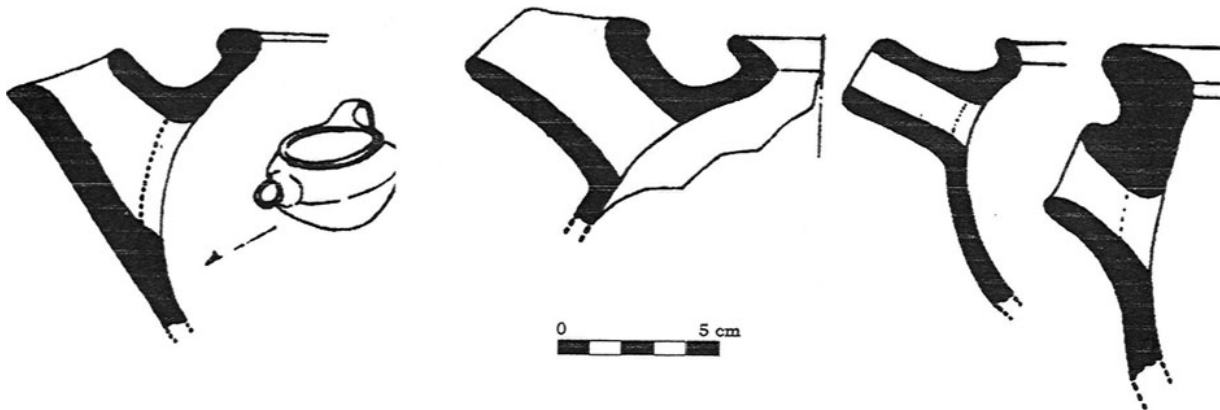

Pl. 259. Pichets à embouchure ronde, trilobée et à bec latéral, Kaman²⁵⁷.

²⁵⁶ ÖZGÜÇ, 1982, fig. M.

²⁵⁷ OMURA, 1992, fig. 13. 1-2, 5-8.

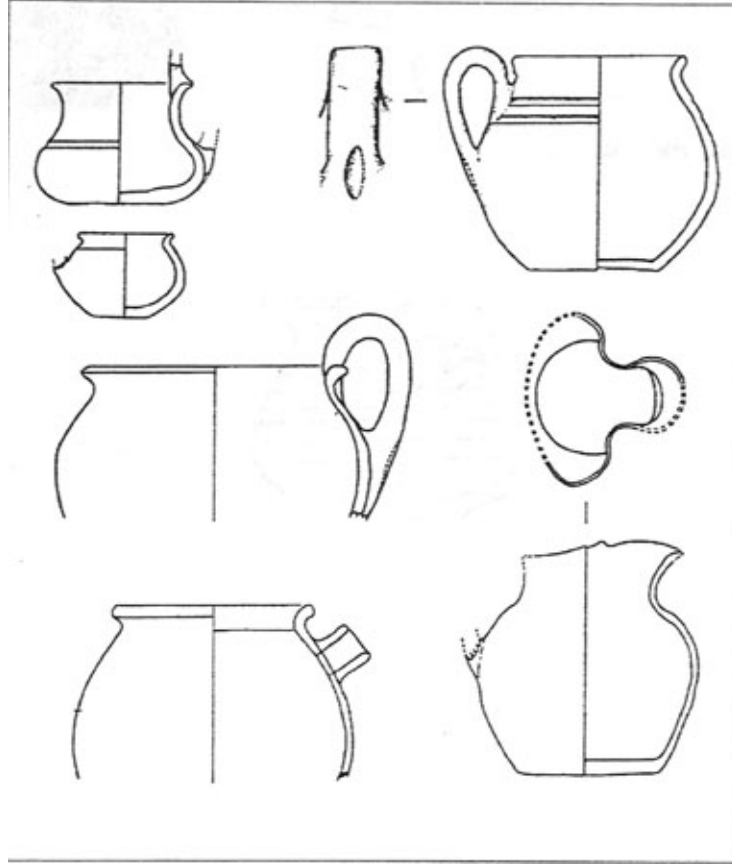

Pl. 260. Pichets à bec latéral, Hacibektaş, Maşat, Kaman, Çalapverdi²⁵⁸.

²⁵⁸ BALKAN, SÜMER, 1967, Res. 44. ÖZGÜÇ, 1982, fig. L.4. OMURA, 1992, fig. 13.3. ÖZGÜÇ, 1971, Res. 163-164.

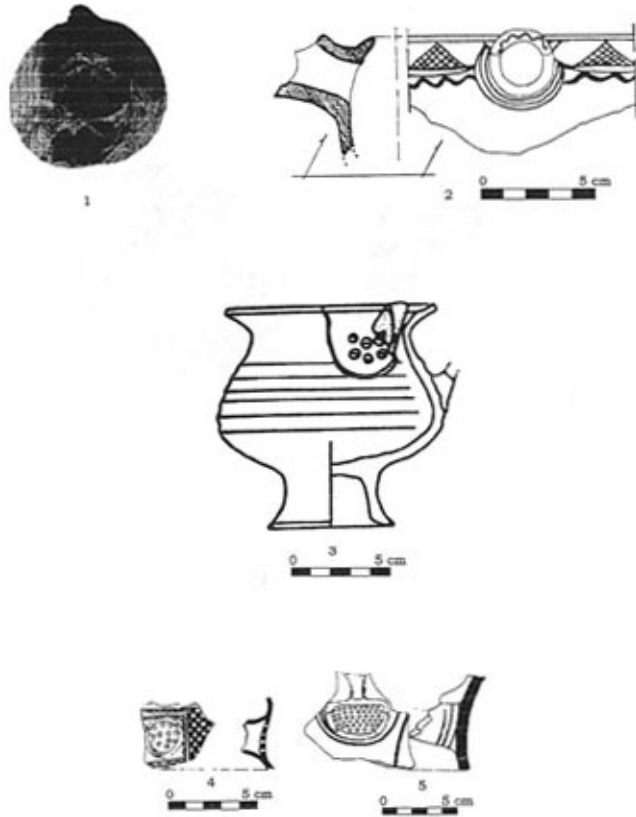

Pl. 261. Pichets à bec latéral, Kültepe²⁵⁹.

²⁵⁹ ÖZGÜÇ, 1971, pl. XVII. 1-2. fig. 58.



Pl. 262. Pichets à bec latéral, Gordion²⁶⁰.

²⁶⁰ YOUNG, 1960, pl. 56. 6-8. SAMS, 1994a, fig. 30.



Pl. 263. Cratères, Gordion²⁶¹.

²⁶¹ SAMS, 1994a, fig. 40.

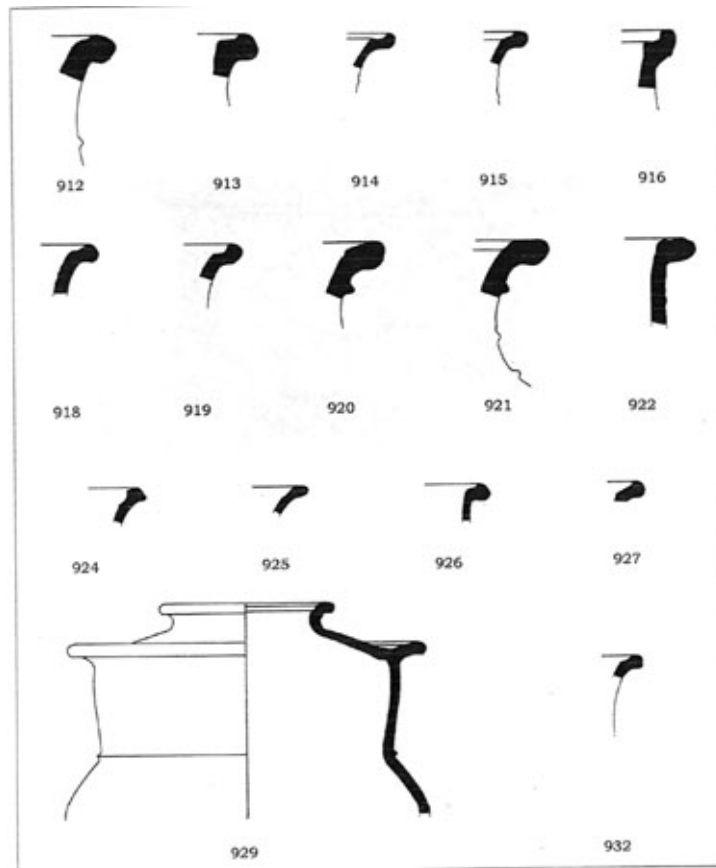

Pl. 264. Cratère, Alişar²⁶².

²⁶² von der OSTEN, 1928-29, pl. II.



Pl. 265. Cratères, Alişar²⁶³.

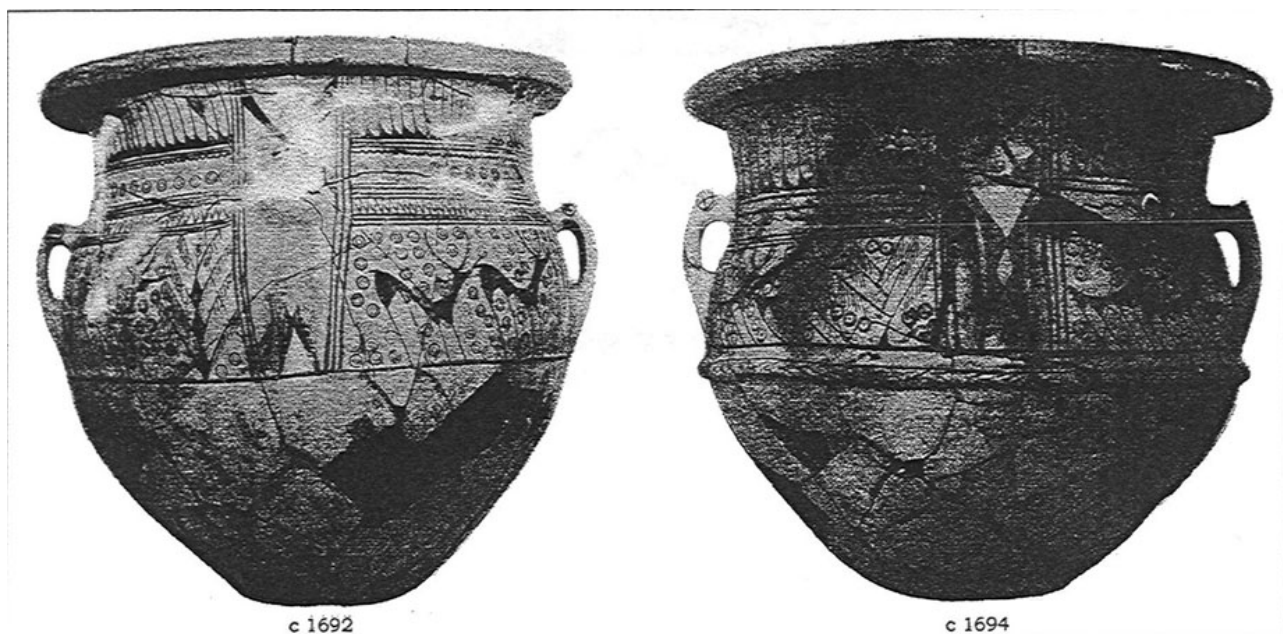

Pl. 266. Cratère, Alişar²⁶⁴.

²⁶³ von der OSTEN, 1930-31, fig. 51.

²⁶⁴ von der OSTEN, 1937, fig. 421.



Pl. 267. Cratères, Alişar²⁶⁵.

²⁶⁵ von der OSTEN, 1937, fig. 424, 426.

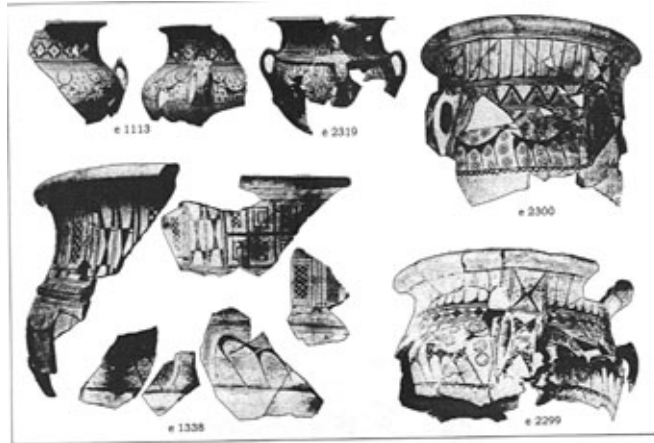

Cratères peints, échelle 1/8, Allşar.
von der OSTEN, 1937, fig. 424.

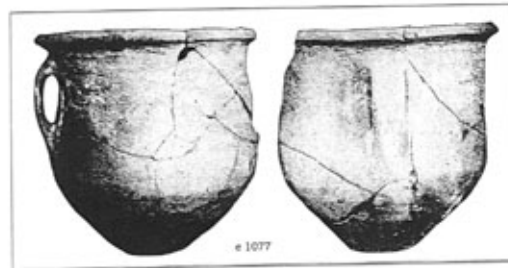

Cratère monochrome, échelle 1/8, Allşar.
von der OSTEN, 1937, fig. 426.

Pl. 268. Cratères, Boğazköy²⁶⁶.

²⁶⁶ BERAN, 1973, Abb. 15.



Pl. 269. Cratères peints, Boğazköy²⁶⁷.

²⁶⁷ BERAN, 1973, Abb. 17.

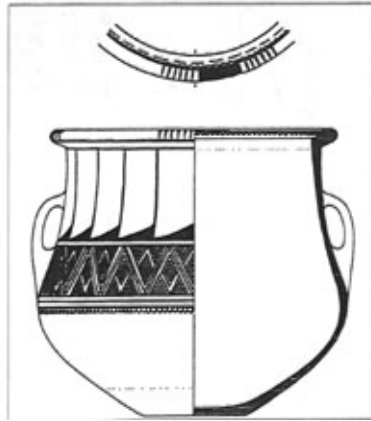

Pl. 270. Cratères, Kültepe²⁶⁸.

²⁶⁸ ÖZGÜÇ, 1971, fig. 64-76.



Pl. 271. Cratères, Kululu²⁶⁹.

²⁶⁹ ÖZGÜÇ, 1971, 41.



Pl. 272. Cratères, Kaman²⁷⁰.

²⁷⁰ OMURA, 1992, fig. 10.4, 3, 6.

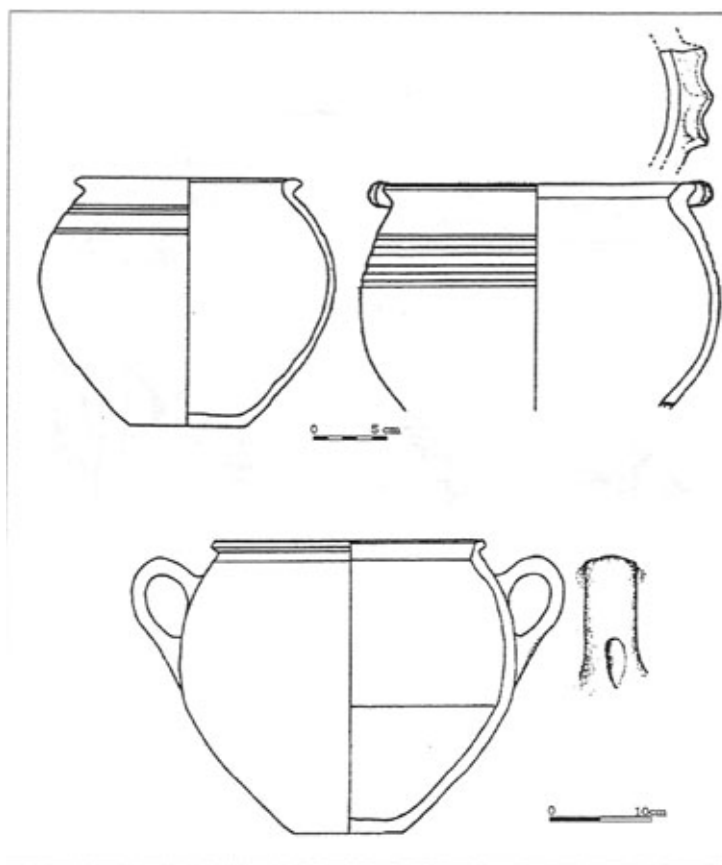

Pl. 273. Dinoi et cratères, Kaman²⁷¹.

²⁷¹ MORI, OMURA, 1993, fig. 11.

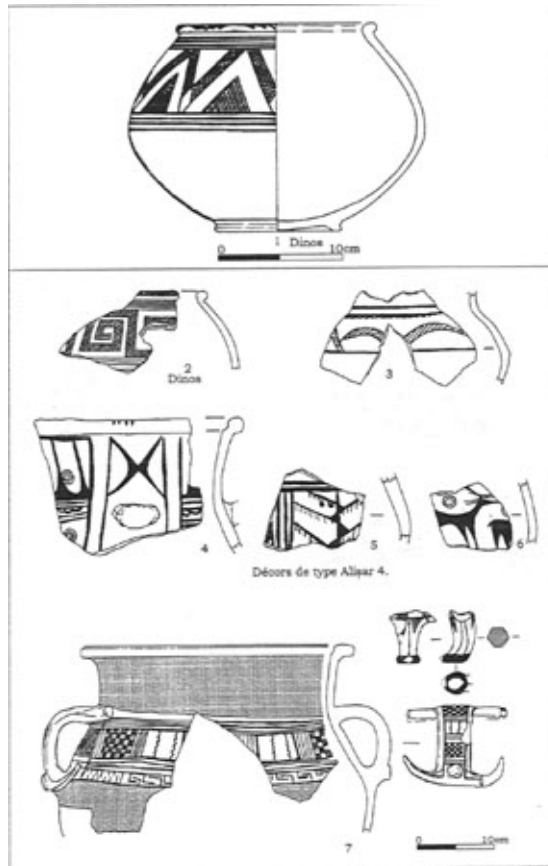

Pl. 274. Vases à décor imprimé et peint, cratères, Kaman²⁷².

²⁷² OMURA, 1995, pl. 19.

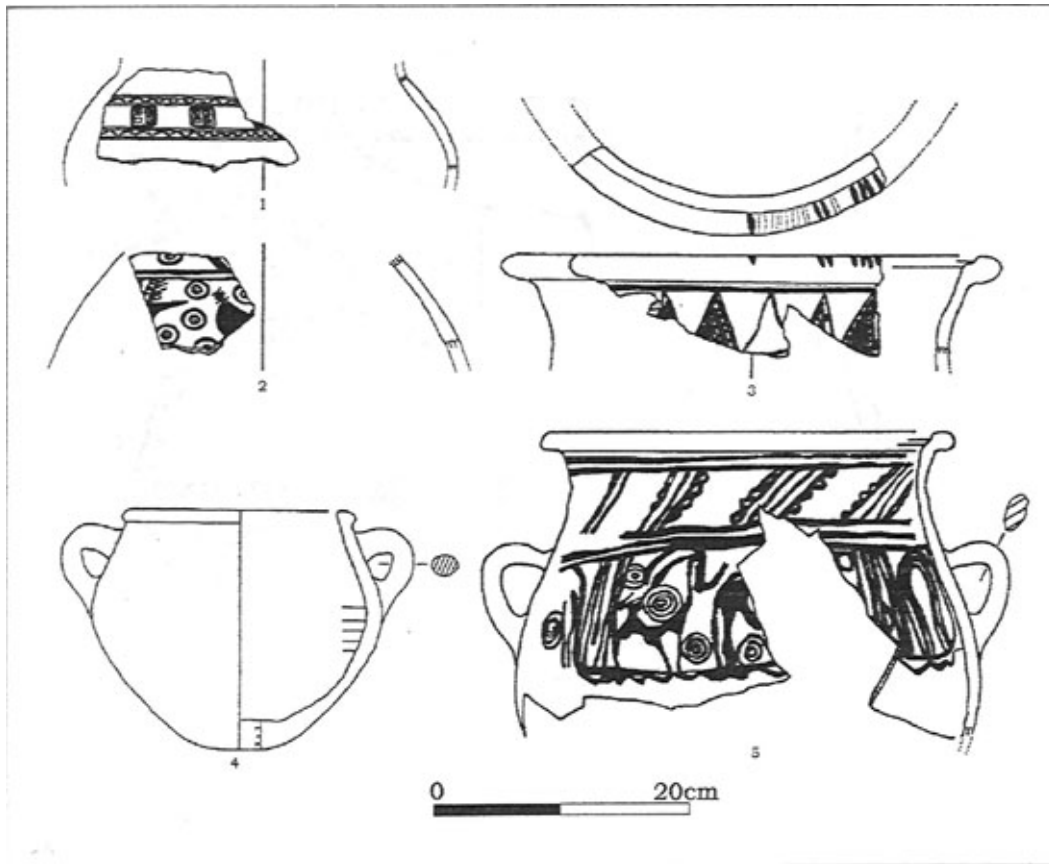

Pl. 275. Cratères, Kaman, Sultanhan, Kültepe²⁷³.

²⁷³ OMURA, 1995, 3, 6 ; 1992, fig. 11. EMRE, 1971, fig. 15. ÖZGÜÇ, 1971, fig. 63.

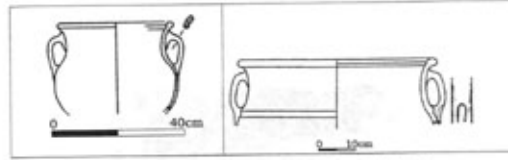

Cratère, Kaman Kalehöyük.
OMURA, 1995, 3, 6.

Cratère, Kaman Kalehöyük.
OMURA, 1992, fig. 11.

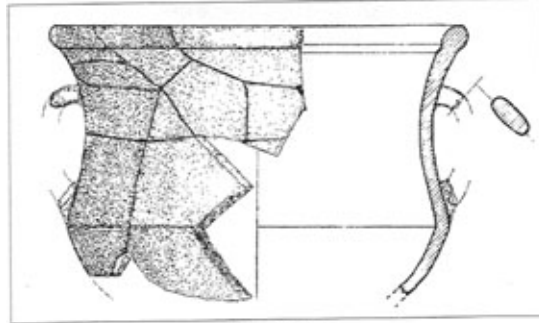

Cratère, Sultanhan.
EMRE, 1971, fig. 15.

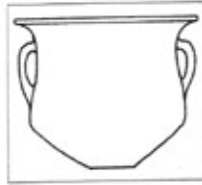

Cratère, Kultepe.
ÖZGÜÇ, 1971, fig. 63.

Pl. 276. Cratères, Karahöyük, Sultanhan²⁷⁴.

²⁷⁴ ÖZGÜÇ, 1949, Lev. XVI-3. EMRE, 1971, fig. 16.



Cratère, Karahöyük.
ÖZGÜÇ, 1948, lev. XVI-3.

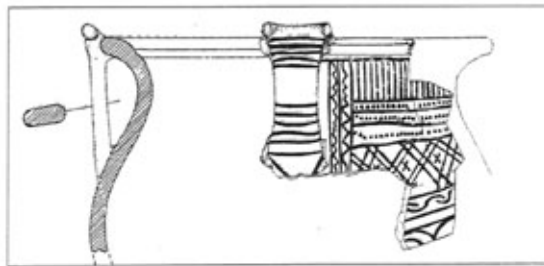

Cratère à anses à rotelle, Sultanhan.
EMRE, 1971, fig. 16.

Pl. 277. Cratère et dinos, Kültepe, Maşat Höyük²⁷⁵.

²⁷⁵ ÖZGÜÇ, 1971, pl. X ; 1982, fig. 143.



Cratère, Kültepe.
ÖZGÜÇ, 1971, pl. X.

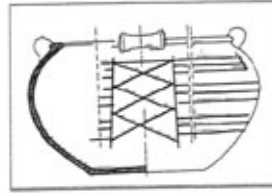

Dinos, Maşat Höyük.
ÖZGÜÇ, 1982, fig. 143.

Pl. 278. Cratères, Maşat Höyük²⁷⁶.

²⁷⁶ ÖZGÜÇ, 1982, fig. 140-141.

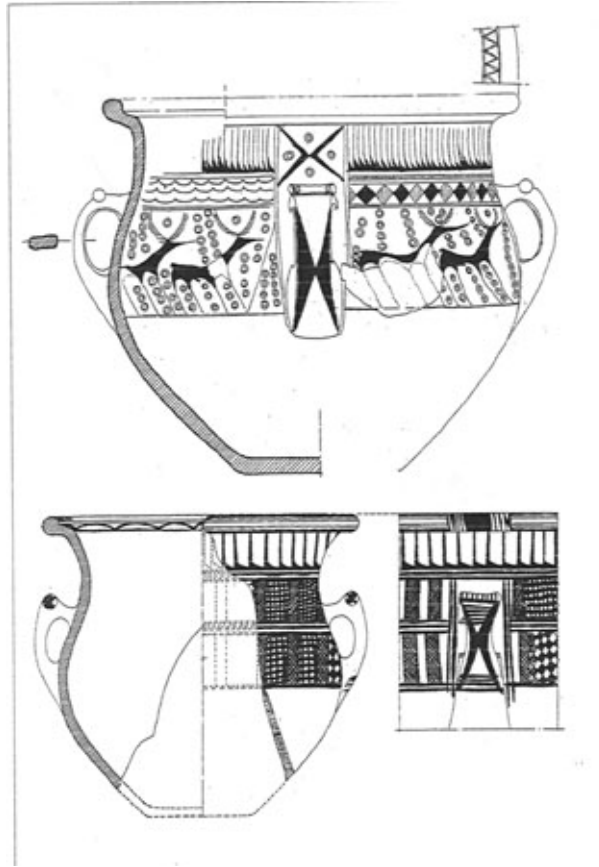

Pl. 279. Cratères, grand vase à bord à replat et jarre à col cylindrique, Maşat Höyük²⁷⁷.

²⁷⁷ ÖZGÜÇ, 1982, fig. 132-137.

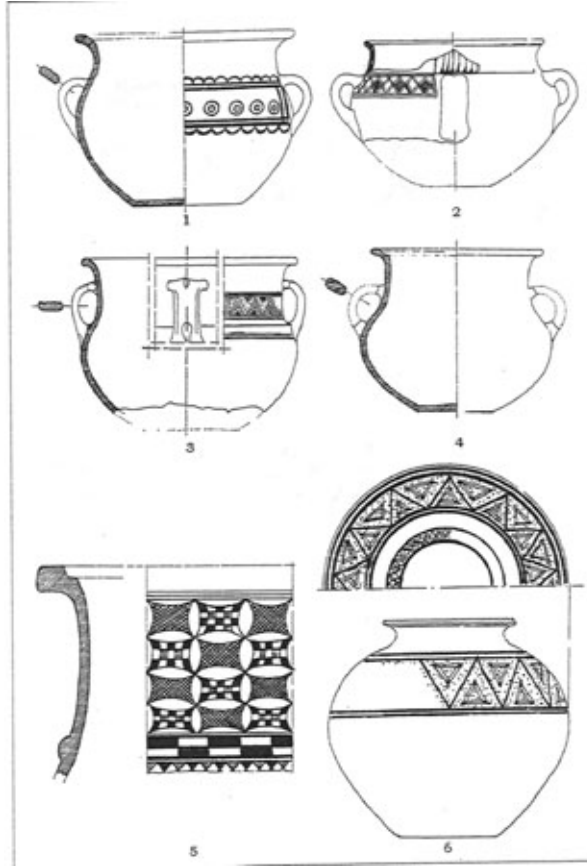

Pl. 280. Cratères, Maşat Höyük²⁷⁸.

²⁷⁸ ÖZGÜÇ, 1982, fig. 138-139.

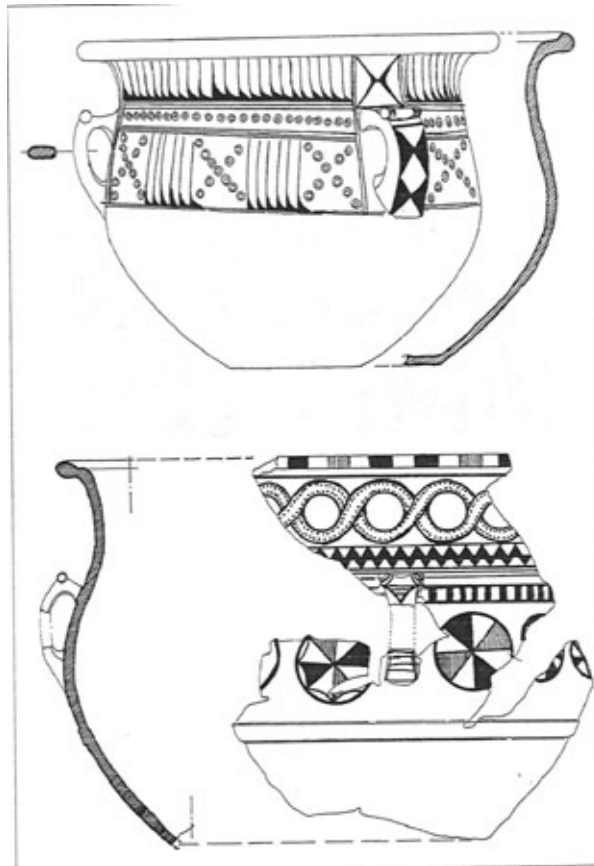

Pl. 281. Cratère, Gordion²⁷⁹.

²⁷⁹ SAMS, 1994a, fig. 42.

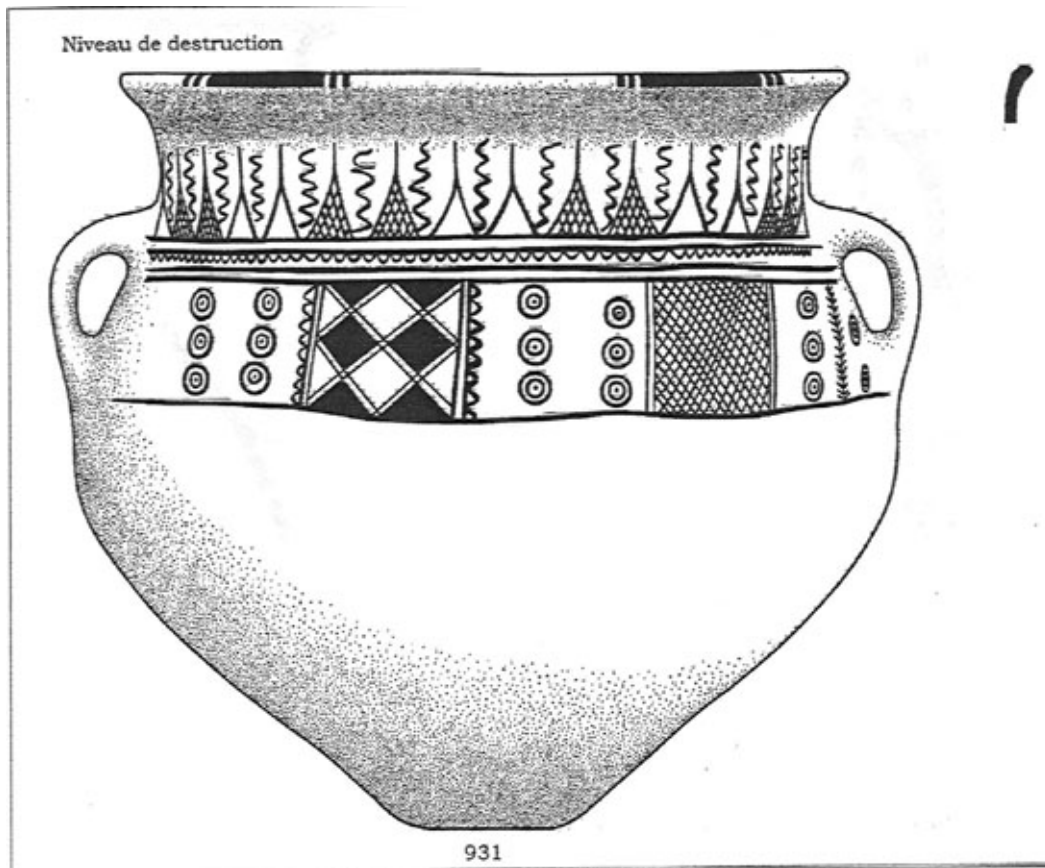

Pl. 282. Cratères-Amphores, Gordion²⁸⁰.

²⁸⁰ SAMS, 1994a, fig.34.

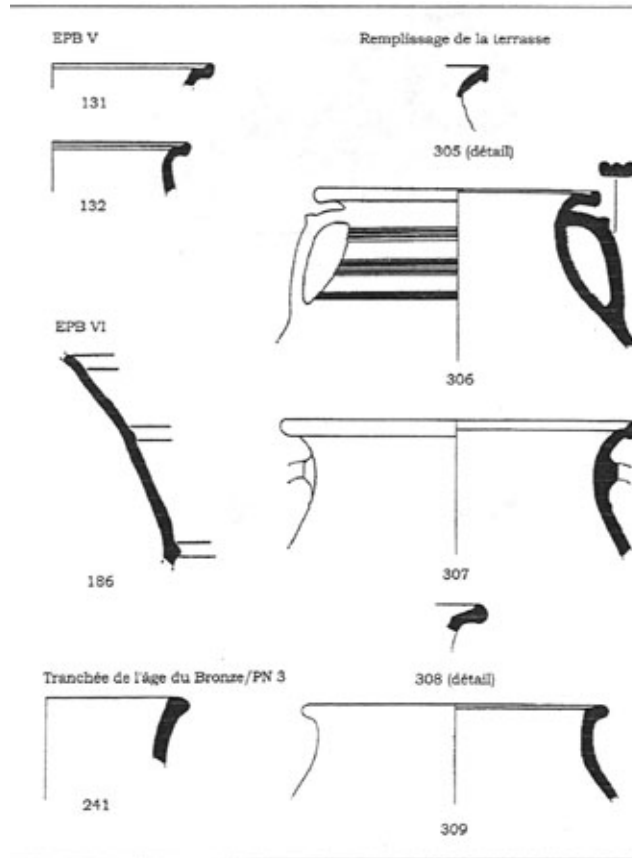

Pl. 283. Cratère, Amphore, Gordion²⁸¹.

²⁸¹ SAMS, 1994a, fig. 41, 37.

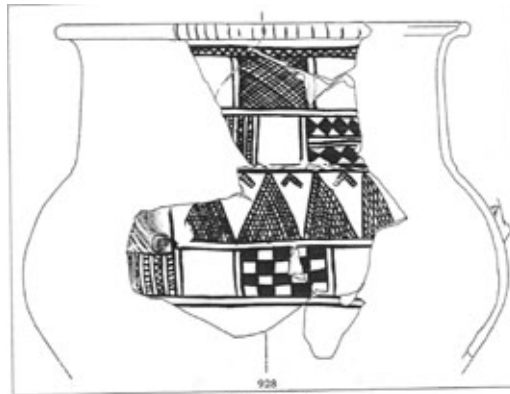

Cratère, Gordion.
SAMS, 1994a, fig. 41.

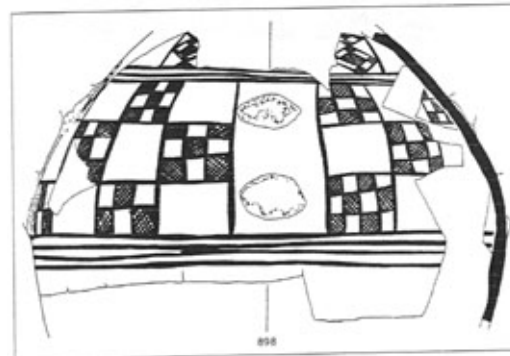

Amphore à anses sur l'épaule, Gordion.
SAMS, 1994a, fig. 37.

Pl. 284. Cratère-Kantharos, Gordion²⁸².

²⁸² SAMS, 1994a, fig. 36.

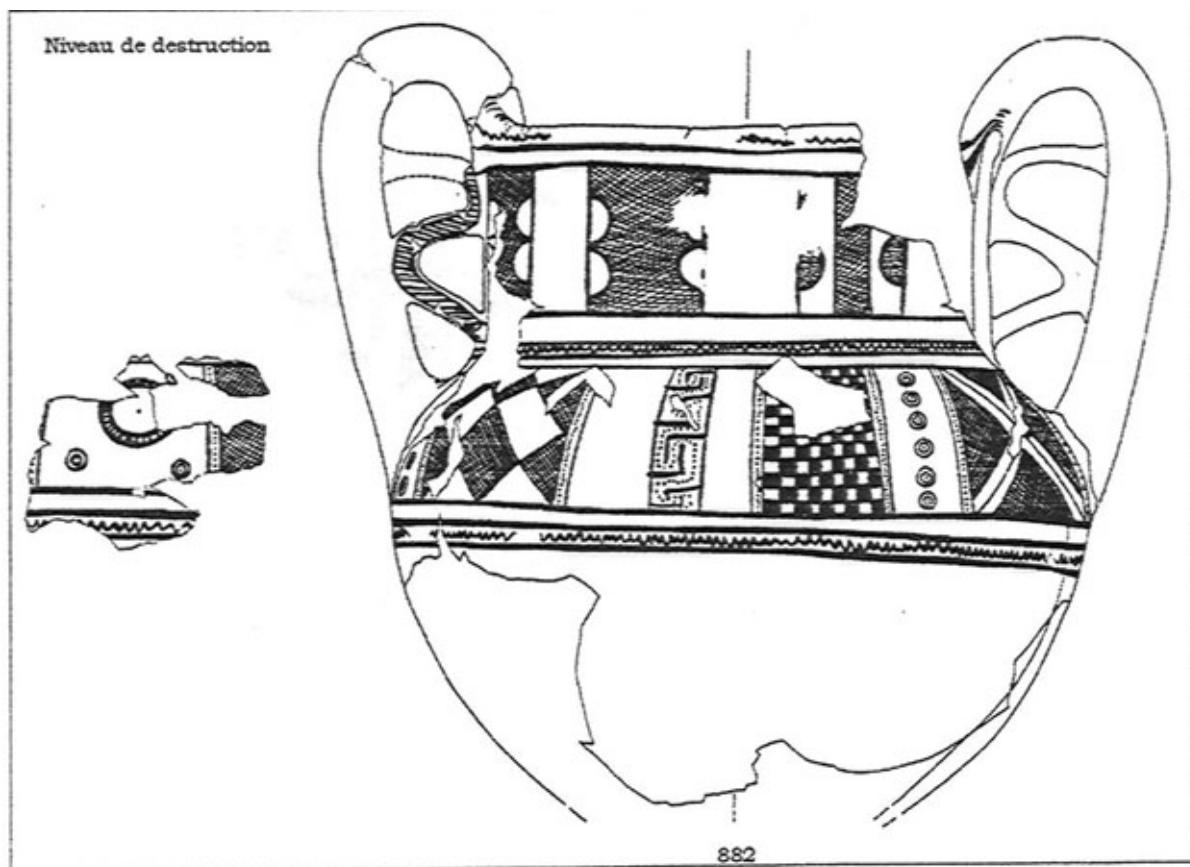

Pl. 285. Cratères, Porsuk²⁸³.

²⁸³ DUPRE, 1983, pl. 87-88.

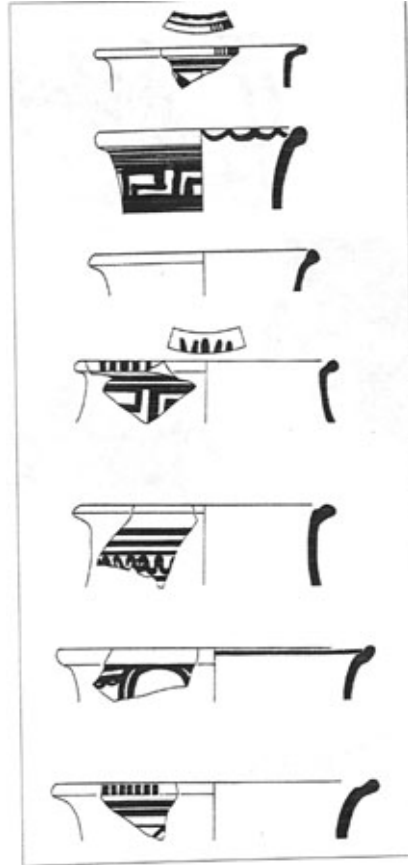

Pl. 286. Cratères, Göllüdağ²⁸⁴.

²⁸⁴ TEZCAN, 1968, 232.



Pl. 287. Tasse et cratère, Göllüdağ²⁸⁵.

²⁸⁵ TEZCAN, 1992, Resim 18-19.

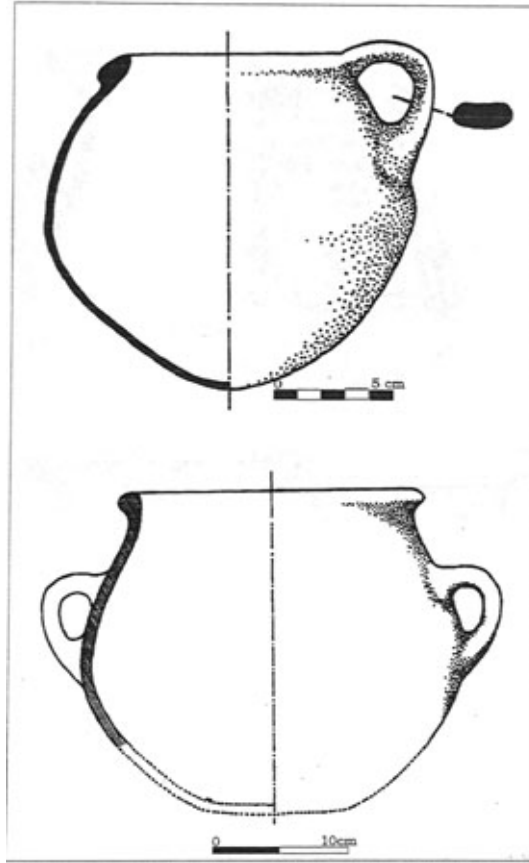

Pl. 288. Cratères, Göllüdağ²⁸⁶.

²⁸⁶ TEZCAN, 1992, Resim 1-2.



Pl. 289. Cratère et amphore, Göllüdağ²⁸⁷.

²⁸⁷ TEZCAN, 1992, Resim 3-4.

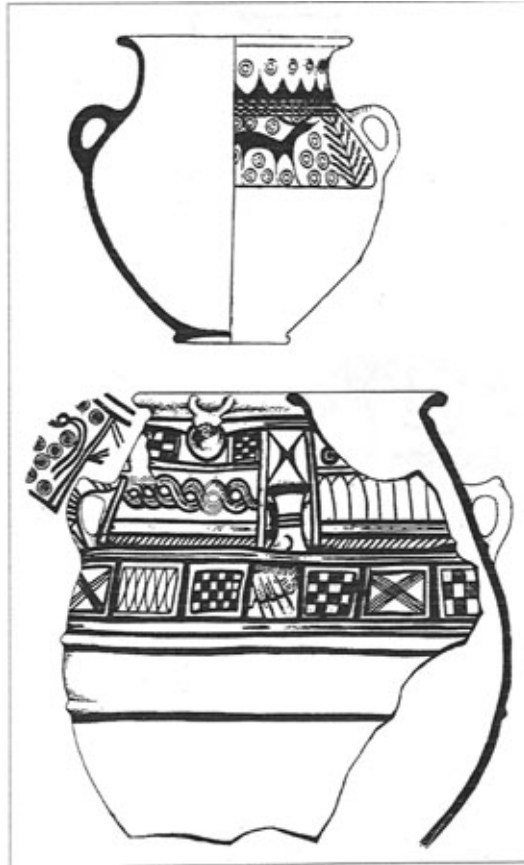

Pl. 290. Vases fermés à embouchure ronde, Kültepe²⁸⁸.

²⁸⁸ ÖZGUÇ, 1971, 14, 76.



Dinos, Kultepe.
Özgüç, &çel&, fig. 76.

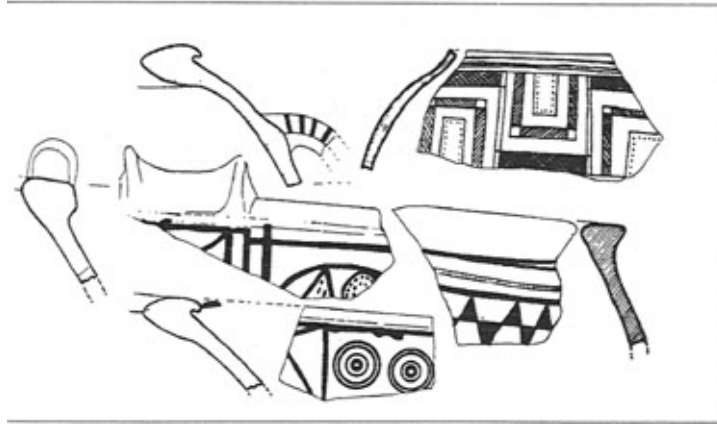

Pl. 291. Dinoi, Maşat²⁸⁹.

²⁸⁹ ÖZGÜÇ, 1982, fig. L.

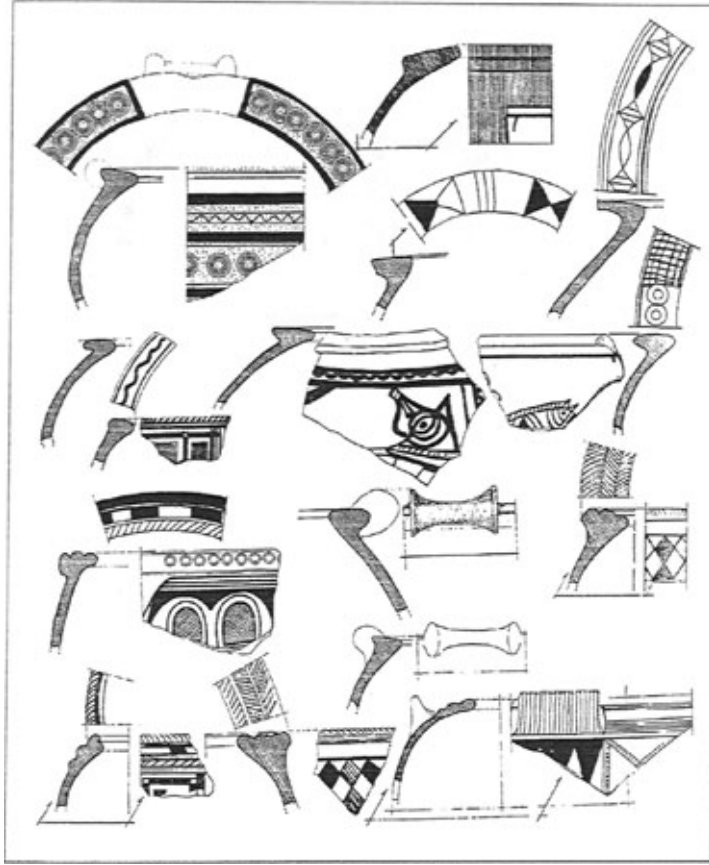

Pl. 292. Dinoi, Karahöyük²⁹⁰.

²⁹⁰ ÖZGÜÇ, 1949, Lev. XXV, XXVI.

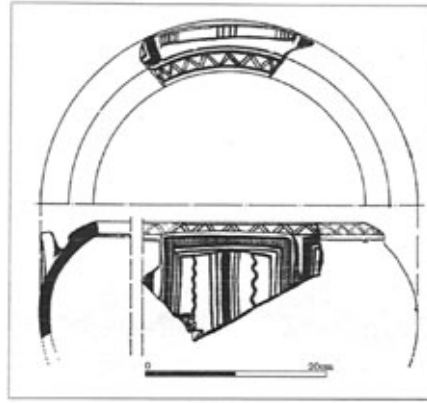

Dinos, Karahöyük.
ÖZGÜÇ, 1948, Lev. XXV.

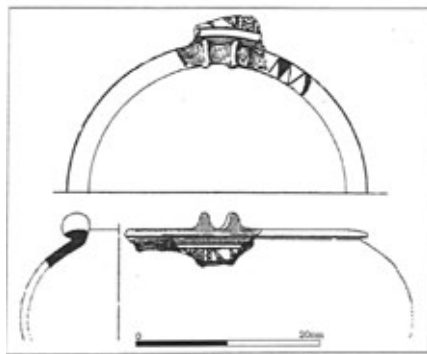

Pl. 293. Dinos à éléments en relief sur le bord, Karahöyük²⁹¹.

²⁹¹ ÖZGÜÇ, 1949, lev. XV.

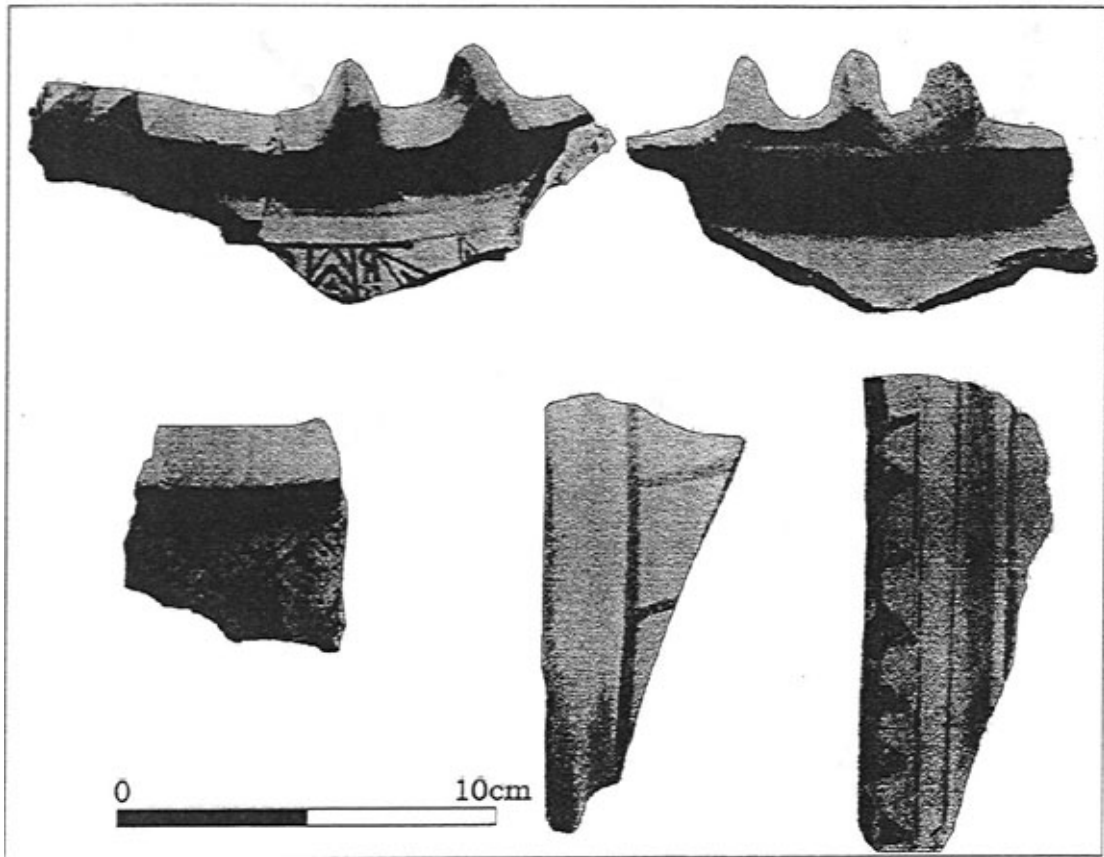

Pl. 294. Jarres à col court et dinoi, Gordion²⁹².

²⁹² SAMS, 1994a, fig. 49.

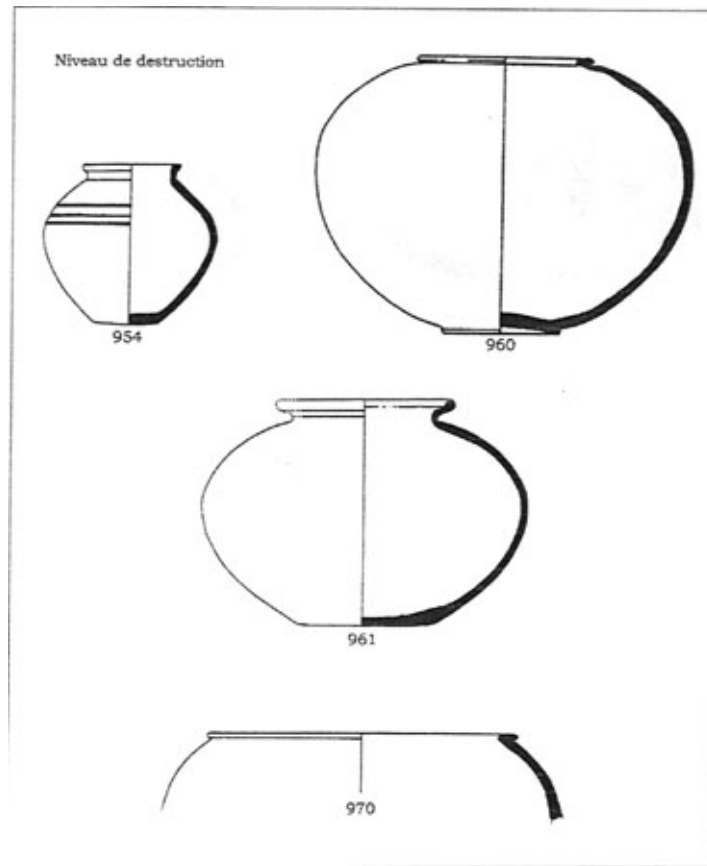

Pl. 295. Dinoi, Gordion²⁹³.

²⁹³ SAMS, 1994a, fig. 48.

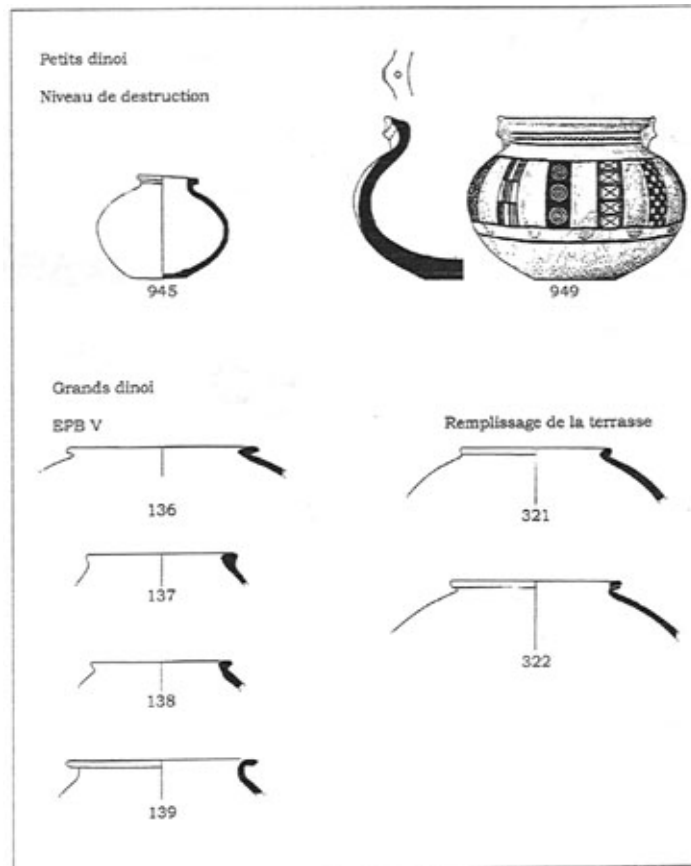

Pl. 296. Poterie de la phase phrygienne moyenne, Gordion²⁹⁴.

²⁹⁴ HENRICKSON, 1994, fig. 10.8.

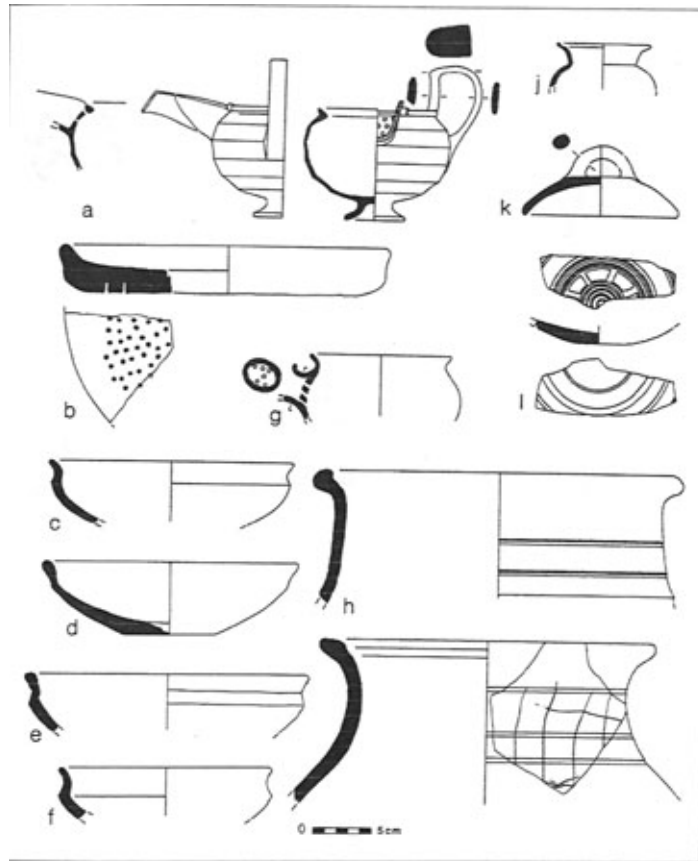

Pl. 297. Jarres à bord à replat, urnes à bord saillant et droit, Çadir²⁹⁵.

²⁹⁵ GORNY *et alii.*, 1995, fig. 19.

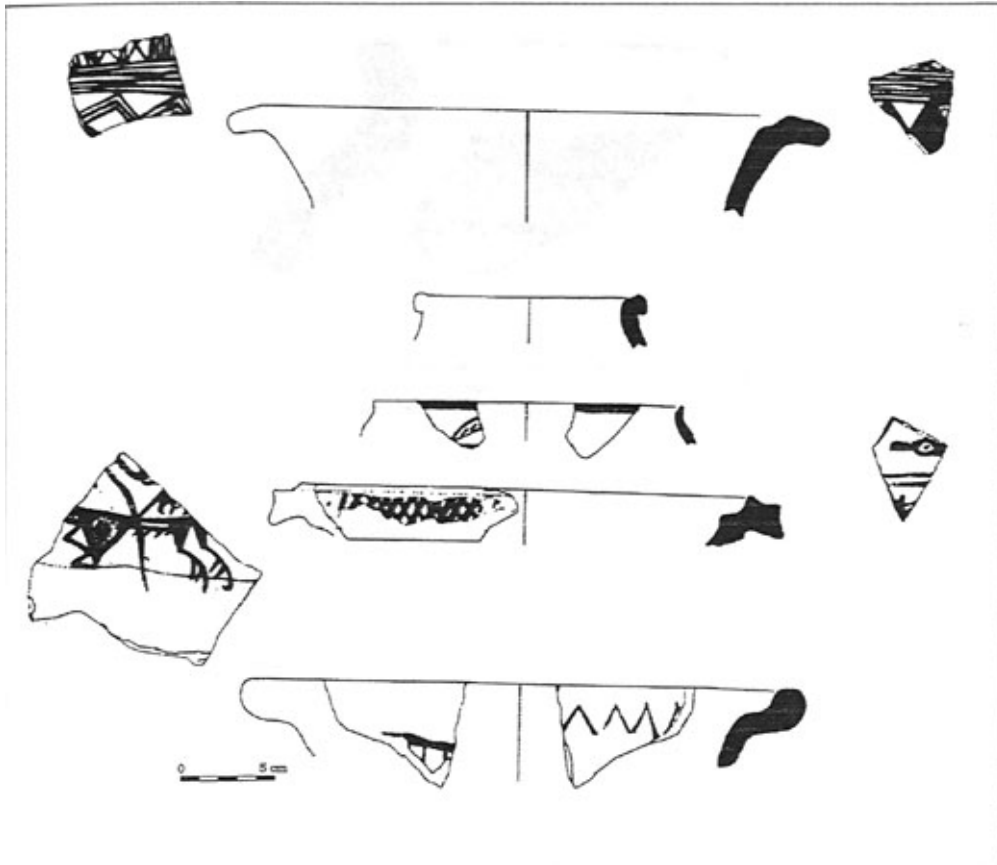

Pl. 298. Urnes à bord droit, Kültepe, Alişar, Sultanhan²⁹⁶.

²⁹⁶ ÖZGÜÇ, 1971, fig. 75. von der OSTEN, 1928-29, pl. XXXIII. EMRE, 1971, fig. 88.



Urne à bord droit, Kültepe.
ÖZGÜÇ, 1971, fig. 75.

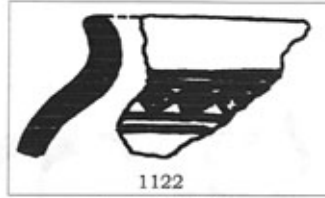

1122
Urne à bord droit, Alisar.
Echelle 1/3.
von der OSTEN, 1928-29, pl. XXXIII.

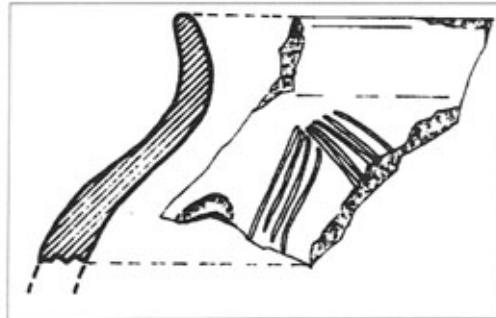

Urne à bord droit à décor incisé, Sultanhan.
EMRE, 1971, fig. 88.

Pl. 299. Vases fermés, Maşat²⁹⁷.

²⁹⁷ ÖZGÜÇ, 1982, fig. N.

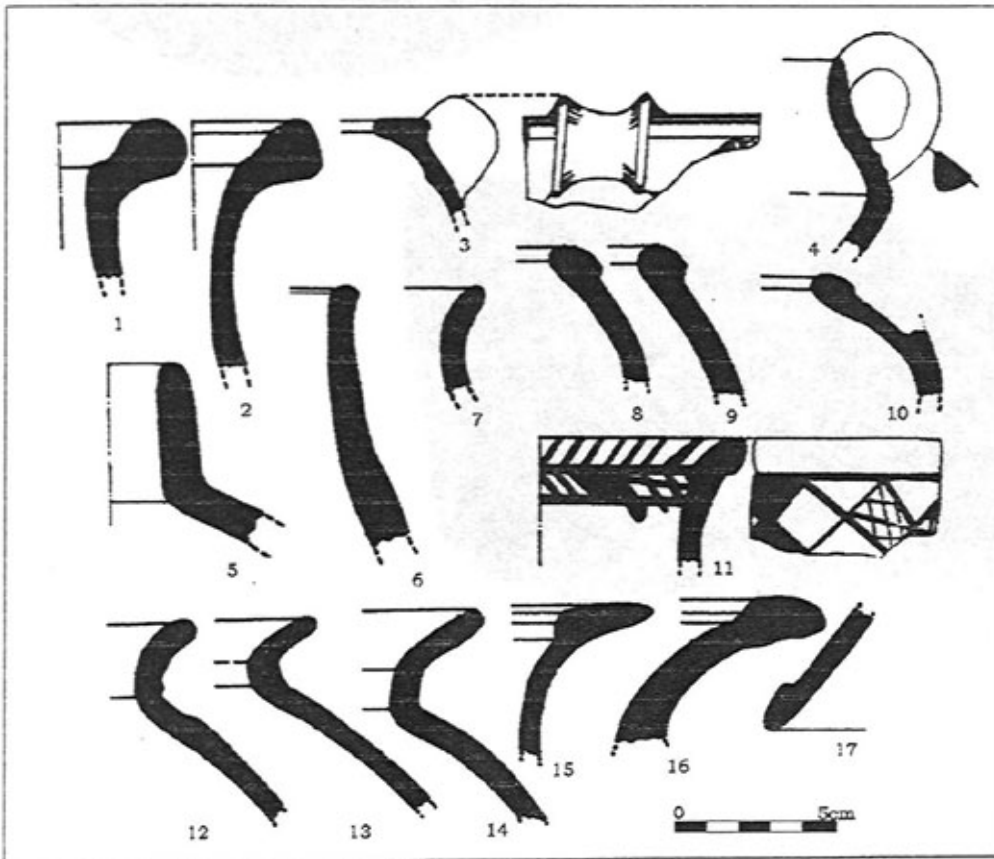

Pl. 300. Urne à embouchure ronde et bord saillant, Hacibektaş²⁹⁸.

²⁹⁸ BALKAN, SÜMER, 1969, 46.



Pl. 301. Vases fermés, Maşat²⁹⁹.

²⁹⁹ ÖZGÜÇ, 1982, fig. M.

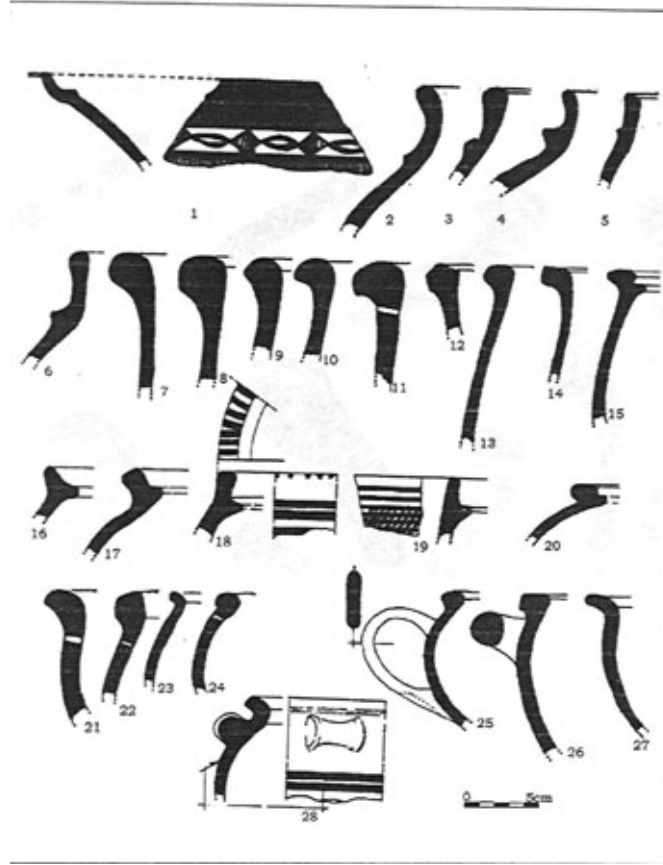

Pl. 302. Vases fermés, Büyük Güllücek³⁰⁰.

³⁰⁰ KOŞAY, 1957, Taf. IX.

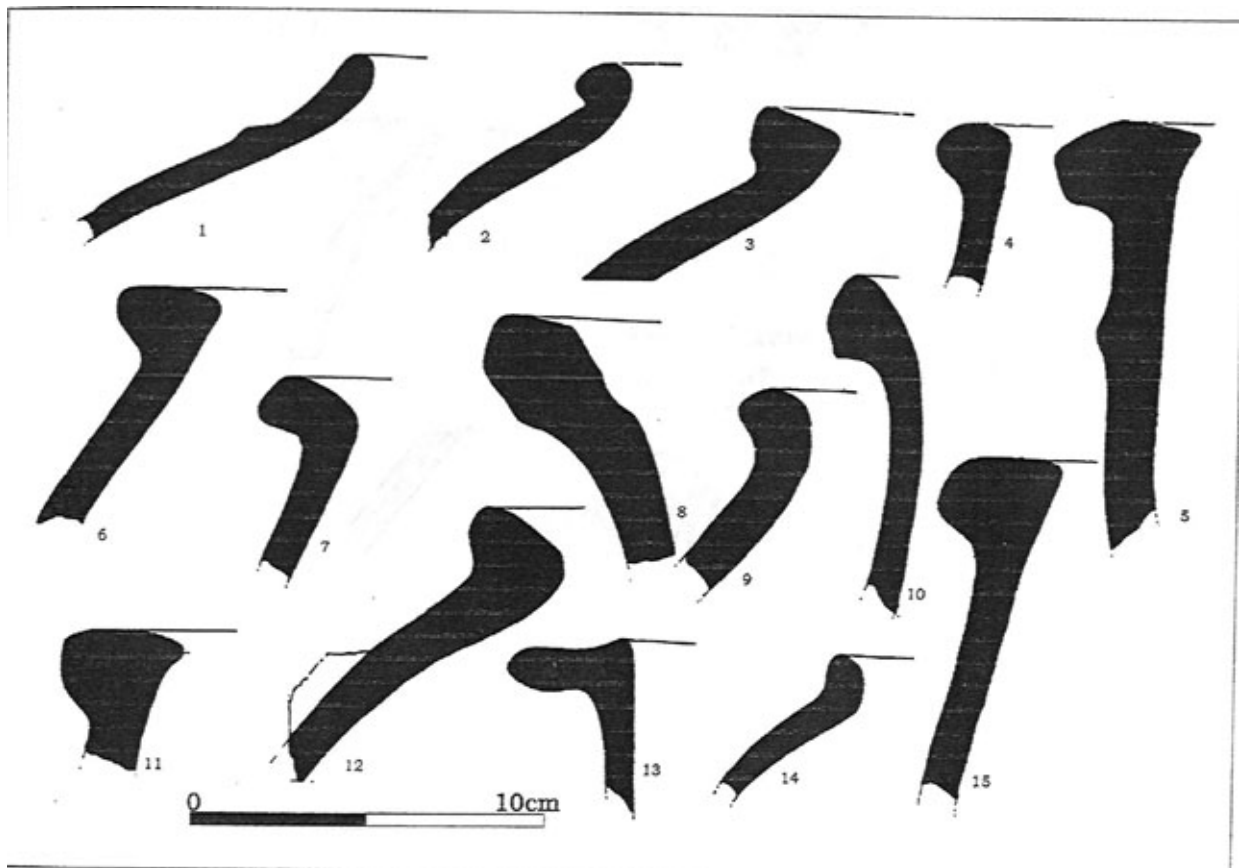

Pl. 303. Urnes à lèvre saillante, Sultanhan³⁰¹.

³⁰¹ EMRE, 1971, fig. 17-19.

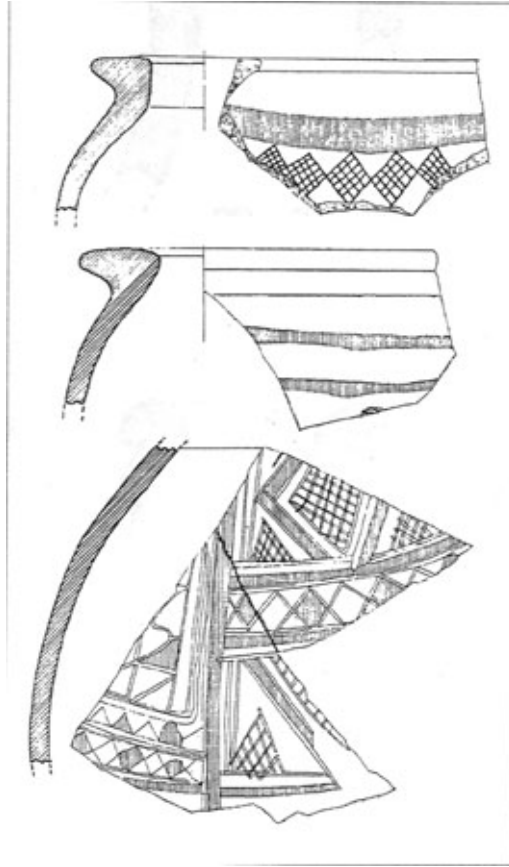

Pl. 304. Petites urnes et vases globulaires à embouchure ronde, Aktepe³⁰².

³⁰² ÖZGÜÇ, 1978, 103.

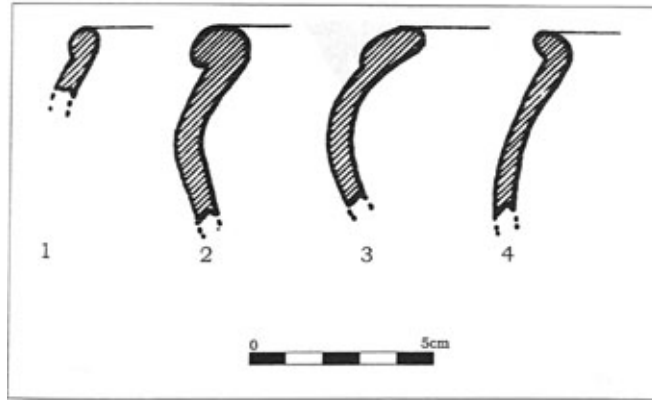
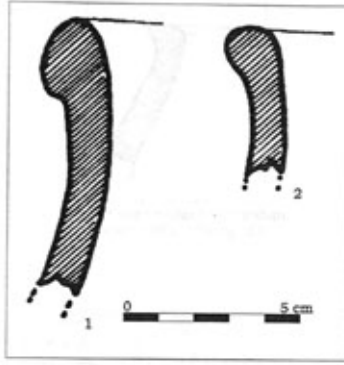

Pl. 305. Urnes à bord saillant, Sultanhan, Kaman, Karahöyük³⁰³.

³⁰³ EMRE, 1971, fig. 82. MIKAMI, OMURA, 1992, fig. 9. 1. 6. ÖZGÜÇ, 1949, pl. XXXVII. 3-4.



Urne à bord saillant, Salsanhan.
EMRE, 1971, 109, fig. 82.

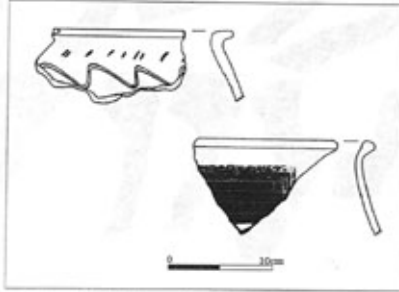

Urnes à bord saillant, et décor incisé et polychrome, Kaman,
MIKAMI, OMURA, 1992, fig. 9. 1. 5.

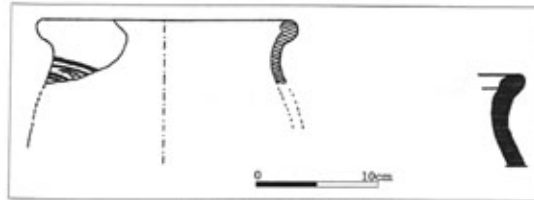

Urne à bord saillant, Karahöyük.
ÖZGÜÇ, 1949, pl. . XXVII. 3-4.

Pl. 306. Urnes et jarres, Karahöyük³⁰⁴.

³⁰⁴ ÖZGÜÇ, 1949, pl. XXXVIII.



Pl. 307. Urnes à bord évasé ou saillant, Karahöyük³⁰⁵.

³⁰⁵ ÖZGÜÇ, 1949, Lev. XXIV.



Pl. 308. Urnes à lèvre saillante, Karahöyük, Kaman³⁰⁶.

³⁰⁶ ÖZGÜÇ, 1948, Lev. XXXIII. OMURA, 1992, fig. 7. 1-3.



Urnes à lèvre saillante, Karaböyük.
ÖZÜÇ, 1948, Lev. XXXIII.

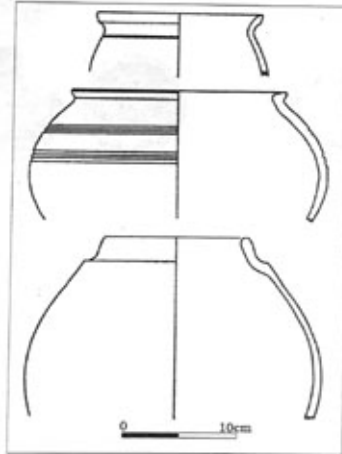

Vases fermés : urne, dinos, jarre de stockage, Kaman.
OMURA, 1992, fig. 7. 1-3.

Pl. 309. Jarres trapues, Alishar, Hacibektaş³⁰⁷.

³⁰⁷ von der OSTEN, 1937, fig. 418. BALKAN, SÜMER, 1967, 4.

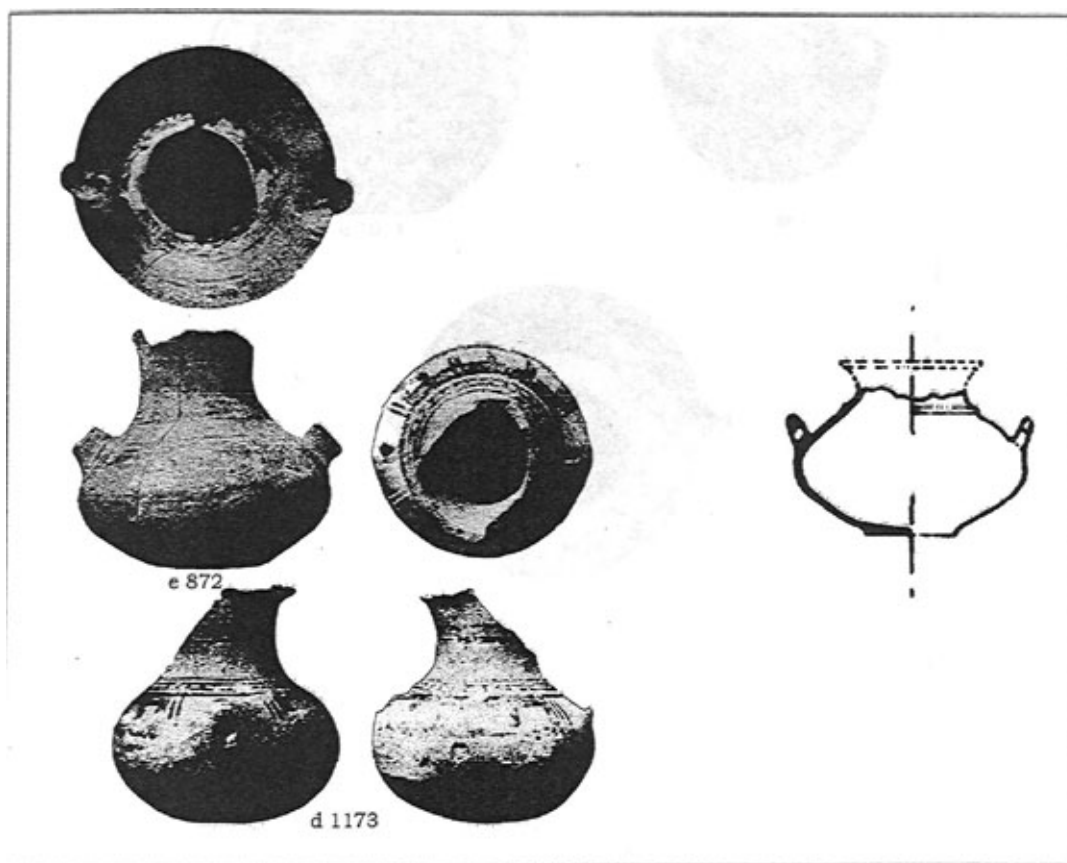

Pl. 310. Jarres à col cylindrique et anse, Alişar³⁰⁸.

³⁰⁸ von der OSTEN, 1937, fig. 419.



Pl. 311. Petites jarres trapues, Kaman, Alişar³⁰⁹.

³⁰⁹ OMURA, 1992, fig. 13.4. von der OSTEN, 1928-29, fig. 61.



Pl. 312. Jarres à col cylindrique, Kululu³¹⁰.

³¹⁰ ÖZGÜÇ, 1973, 16.

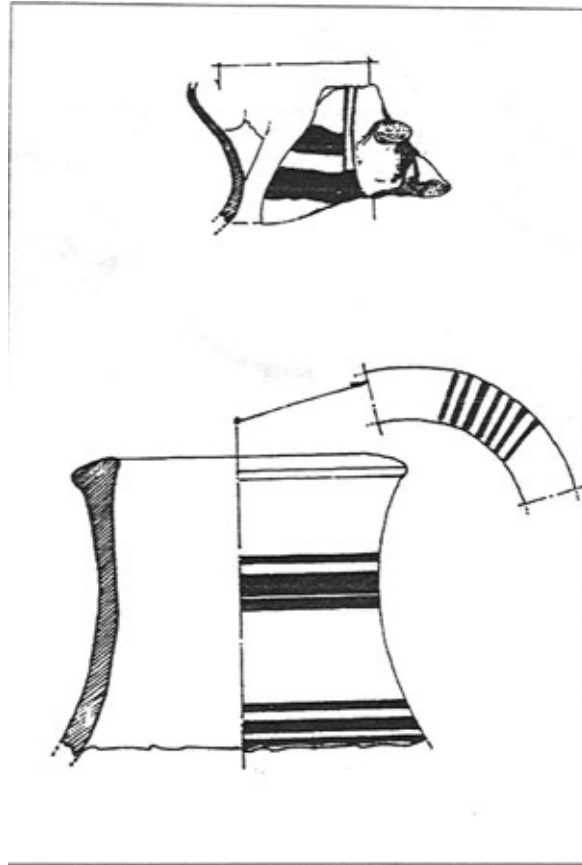

Pl. 313. Poterie de la phase phrygienne moyenne, jarre à col cylindrique sans anse, Gordion³¹¹.

³¹¹ HENRICKSON, 1994, fig. 10. 7.

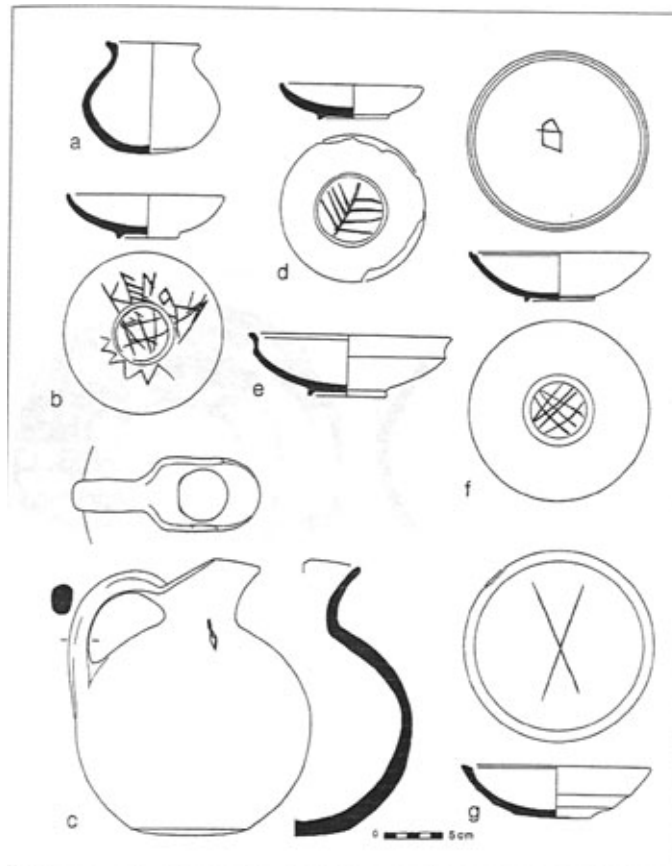

Pl. 314. Jarre à panse biconique, Alişar³¹².

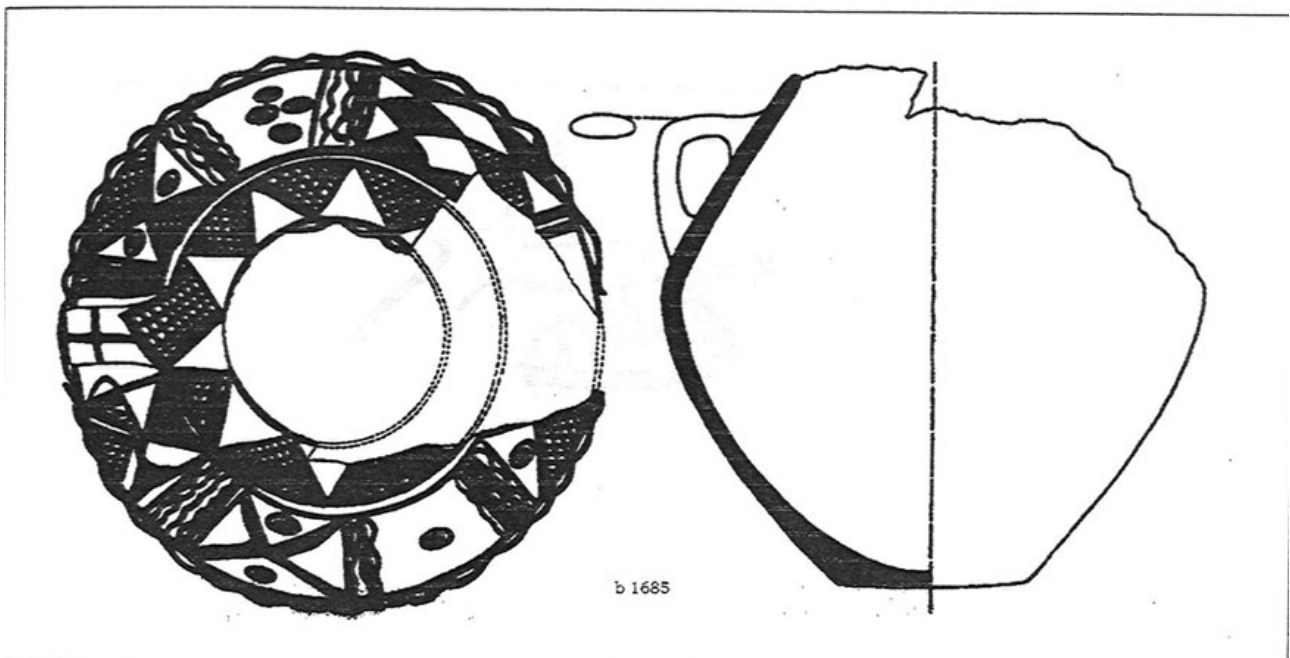

Pl. 315. Jarres à col cylindrique, Kültepe, Maşat³¹³.

³¹² von der OSTEN, 1928-29, pl. XXVIII.



Jarres, amphores à col cylindrique, Kültepe.
ÖZGÜÇ, 1971, Pl. XIV. 6-7.

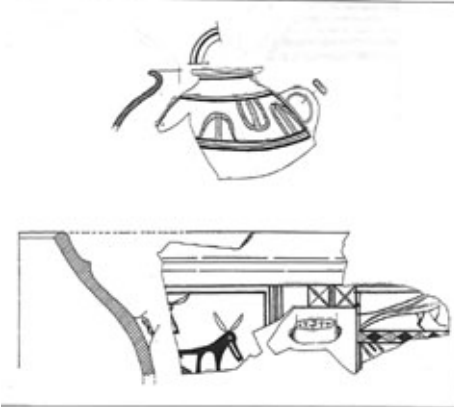

Jarre à col cylindrique et anses, Maşat.
ÖZGÜÇ, 1982, fig. 144-145.

Pl. 316. Jarres à col cylindrique sans anse, Kaman³¹⁴.

³¹³ ÖZGÜÇ, 1971, pl. XIV. 6-7. ÖZGÜÇ, 1982, fig. 144-145.

³¹⁴ MORI, OMURA, 1989, Resim 11.

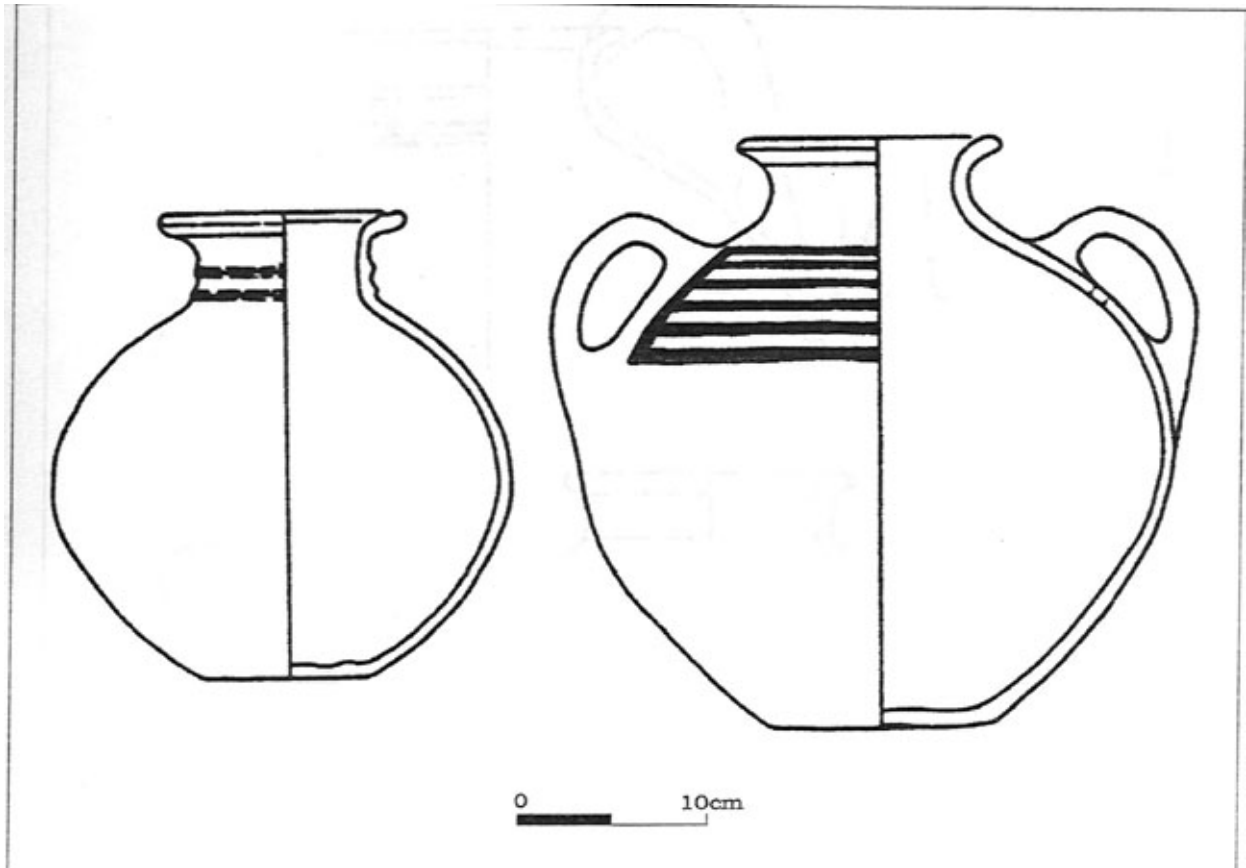

Pl. 317. Jarres à embouchure ronde, Kaman³¹⁵.

³¹⁵ OMURA, 1992, fig. 12. 3-5.

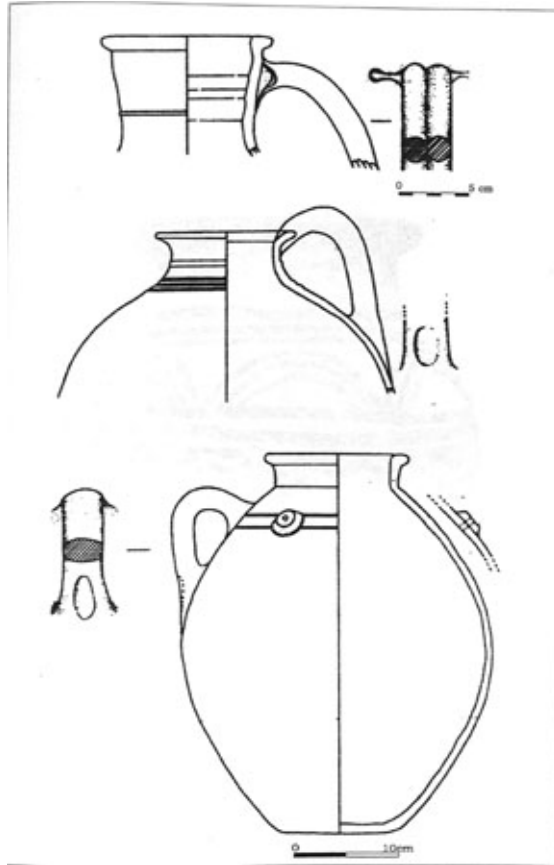

Pl. 318. Jarre à col cylindrique, Alişar³¹⁶.

³¹⁶ von der OSTEN, 1937, fig. 418.

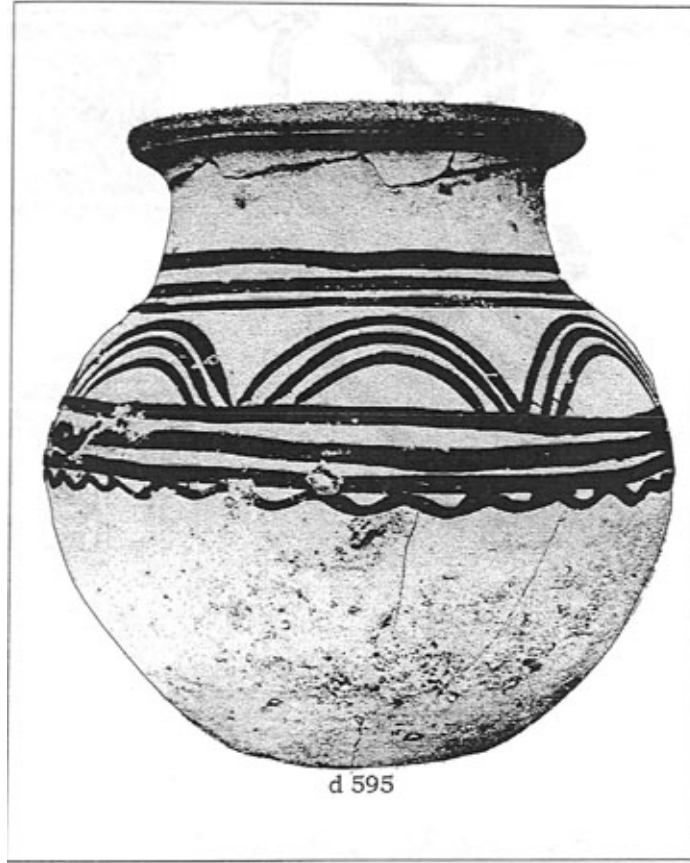

Pl. 319. Jarres à col cylindrique, Kululu³¹⁷.

³¹⁷ ÖZGÜÇ, 1971, fig. 135-142.



Pl. 320. Jarres à col cylindrique, Kayapınar, Sultanhan³¹⁸.

³¹⁸ TEMIZER, 1954, Resim 10 a-b. EMRE, 1971, 102.

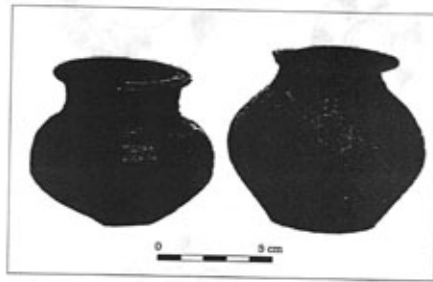

Jarres à col cylindrique, Kayapinar.
TEMIZER, 1954, Resim 10 a-b.

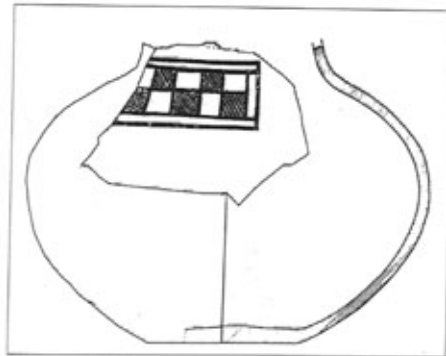

Jarre à col cylindrique, Sultanhan.
EMRE, 1971, 102.

Pl. 321. Jarres à embouchure ronde, Kaman³¹⁹.

³¹⁹ OMURA, 1992, fig. 14. 2-4. 10. 1, 2, 5.

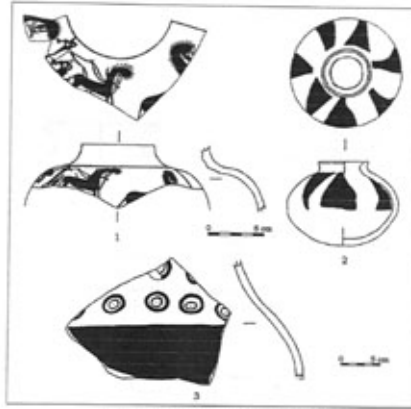

Jarre à embouchure ronde, Kaman.
OMURA, 1992, fig. 14.2-4.

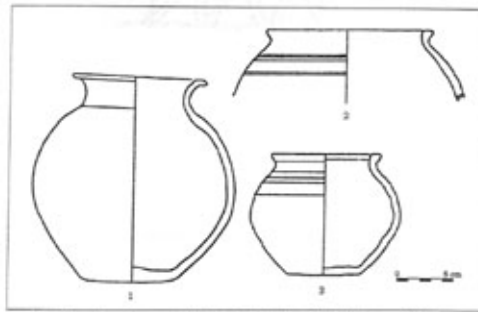

Jarres à embouchure ronde et col cylindrique (1, 3) et urne (2), Kaman.
OMURA, 1992, fig. 10. 1, 2, 5.

Pl. 322. Jarres à col cylindrique, Kaman³²⁰.

³²⁰ OMURA, 1992, fig. 12. 1-2. MIKAMI, OMURA, 1992, fig. 9.8.

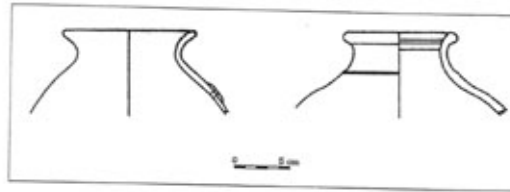

Jarres à col cylindrique, Kaman.
OMURA, 1992, fig. 12. 1-2.

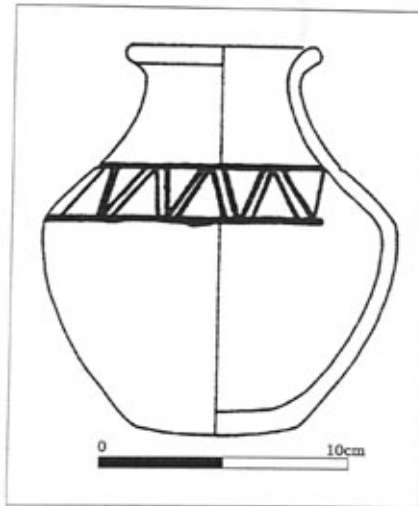

Jarre à col cylindrique, Kaman.
MIKAMI, OMURA, 1992, fig. 9.8.

Pl. 323. Jarre à col cylindrique, Gordion³²¹.

³²¹ SAMS, 1994a, fig. 23.

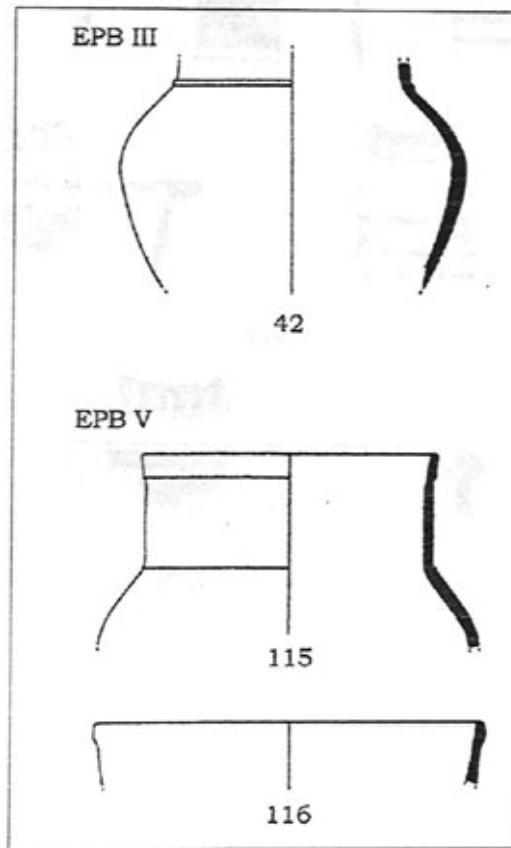

Pl. 324. Jarres à col cylindrique, niveau IV, Porsuk³²².

³²² DUPRE, 1983, pl. 54.

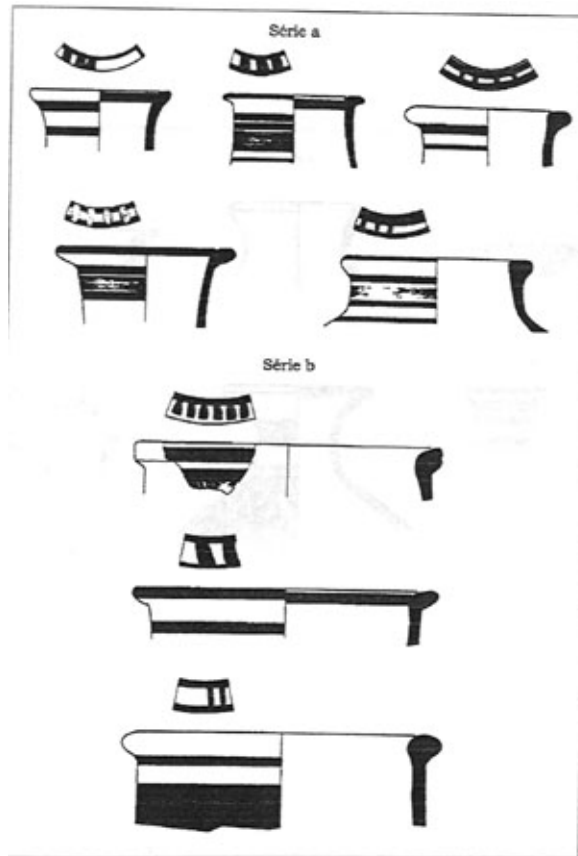

Pl. 325. Jarres à col cylindrique, Porsuk³²³.

³²³ DUPRE, 1983, pl. 84.

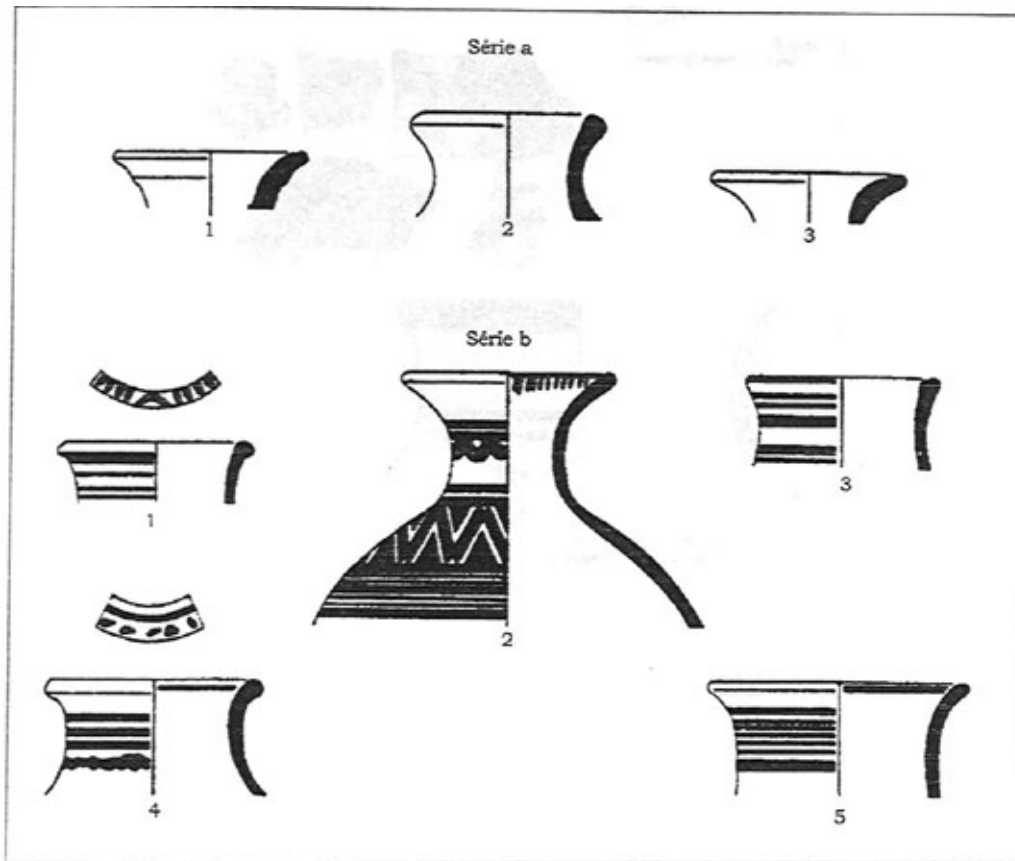

Pl. 326. Jarres à col cylindrique, Göllüdağ³²⁴.

³²⁴ TEZCAN, 1968, Resim 27-30, 31.



Tessons et jarre à col cylindrique et bord évasé, Gölödağ.
TEZCAN, 1968, Resim 27-30.

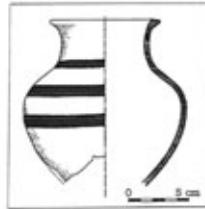

Jarre à col cylindrique, Gölödağ.
TEZCAN, 1968, Resim 31.

Pl. 327. Jarres à col tronconique, série a et b, Porsuk³²⁵.

³²⁵ DUPRE, 1983, pl. 53

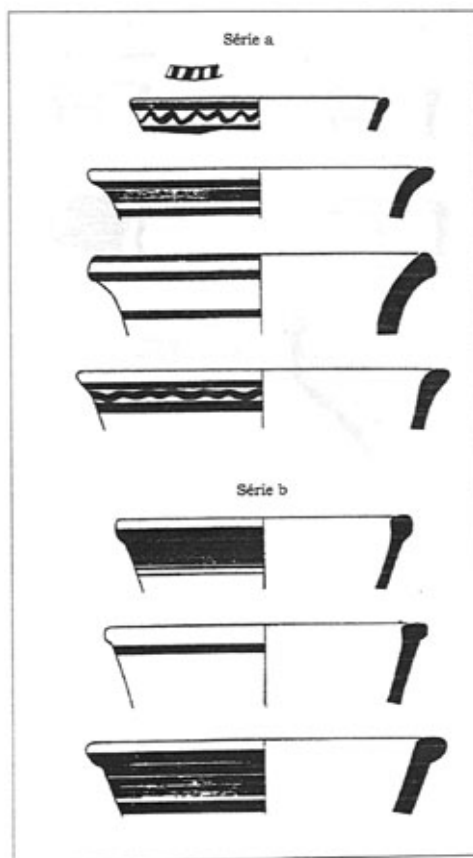

Pl. 328. Vases à col cannelé et cruches à bec pincé, Porsuk³²⁶.

³²⁶ DUPRE, 1982, pl. 85.

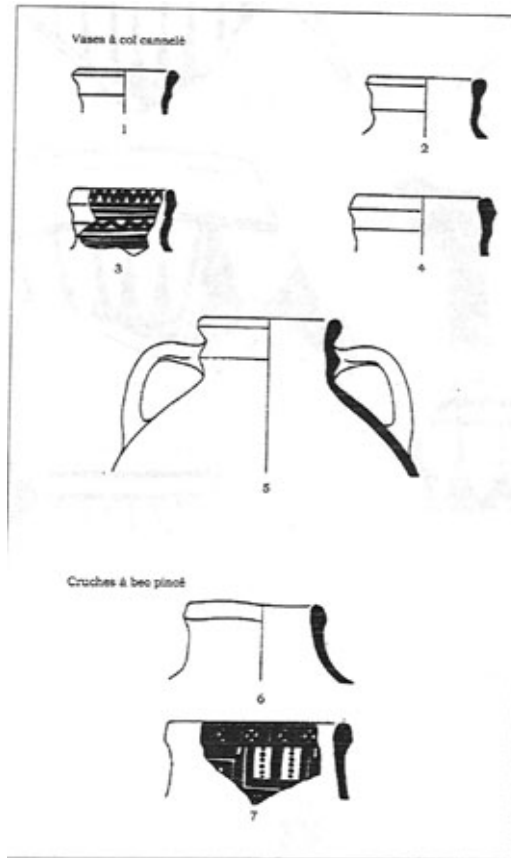

Pl. 329. Vases fermés, Alişar³²⁷.

³²⁷ von der OSTEN, 1928-29, pl. XLII.

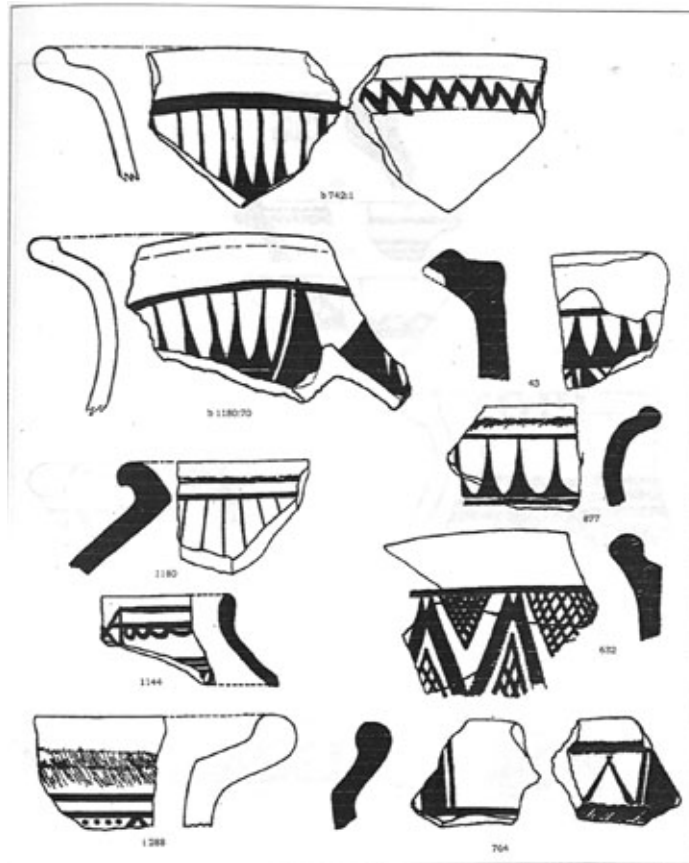

Pl. 330. Vases fermés, Alişar³²⁸.

³²⁸ von der OSTEN, 1928-29, pl. XLIII.



Pl. 331. Jarres à bord à replat et tasses, Maşat³²⁹.

³²⁹ ÖZGÜÇ, 1982, fig. K.

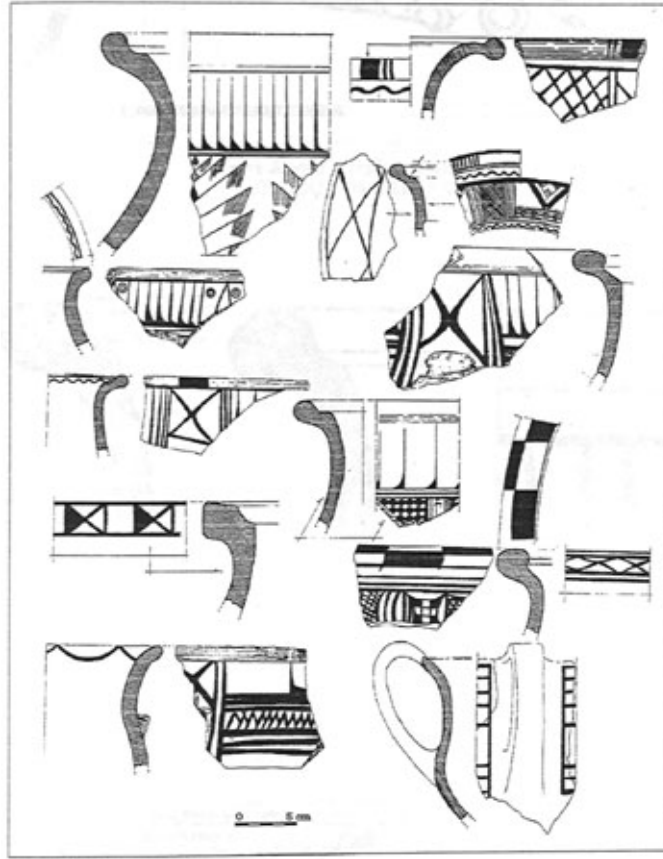

Pl. 332. Jarres à bord à replat, Karahöyük, Aktepe, Kululu³³⁰.

³³⁰ ÖZGÜÇ, 1949, Lev. XXVI ; 1978, fig. 106-107 ; 1971, fig. 134.

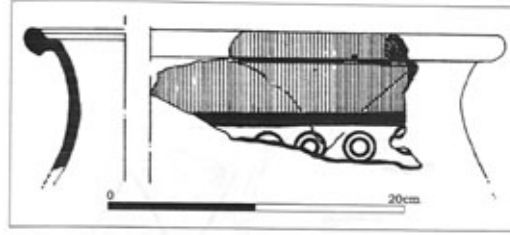

Jarre à bord à replat, Karabdyk.
ÖZGÜÇ, 1949, Lev XXVI.

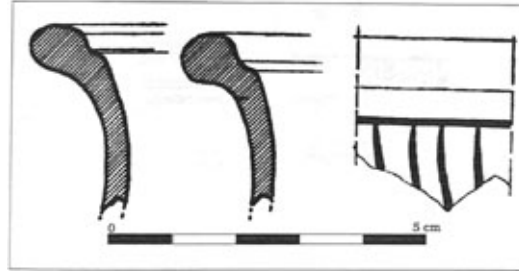

Jarre à bord à replat, Aktepe.
ÖZGÜÇ, 1978, fig. 106-107.

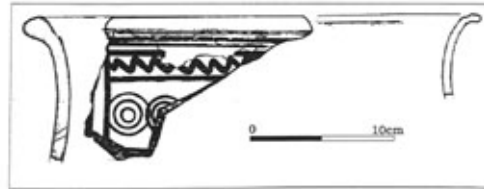

Jarre à bord à replat, Külulu.
ÖZGÜÇ, 1971, fig. 134.

Pl. 333. Vases à bord à replat et col droit, Kültepe³³¹.

³³¹ ÖZGÜÇ, 1971, 25.



Pl. 334. Jarres à bord à replat, Tepebağları, Küçük Höyük³³².

³³² ÇINAROĞLU, 1976, 128. ÖZKAN, 1990, fig. 33-34.



Jarre à col haut et bord à replat, Tepedağlar.
ÇINAROĞLU, 1976, 128.

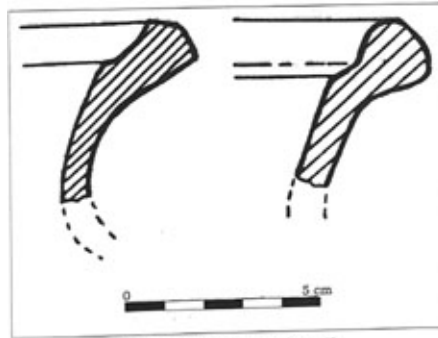

Jarres à bord à replat, Küçük Höyük.
ÖZKAN, 1990, Fig. 33-34.

Pl. 335. Jarres à bord à replat, Gordion³³³.

³³³ SAMS, 1994a, fig. 54.

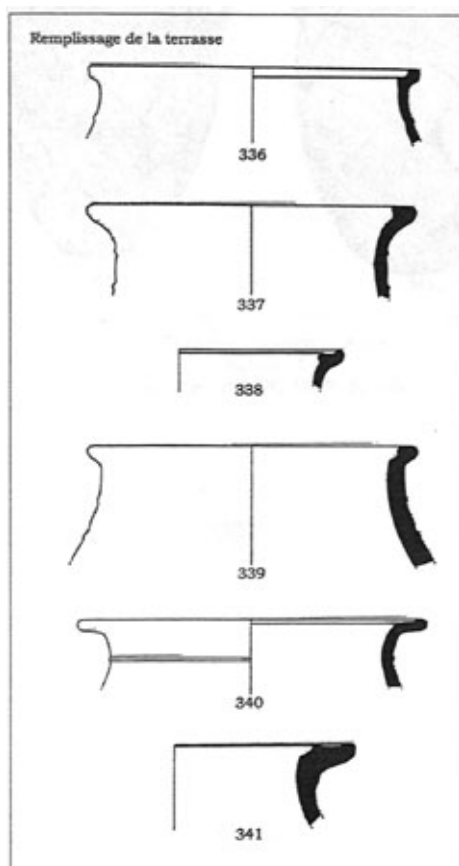

Pl. 336. Grandes amphores, Alişar³³⁴.

³³⁴ von der OSTEN, 1937, fig. 427, 420.

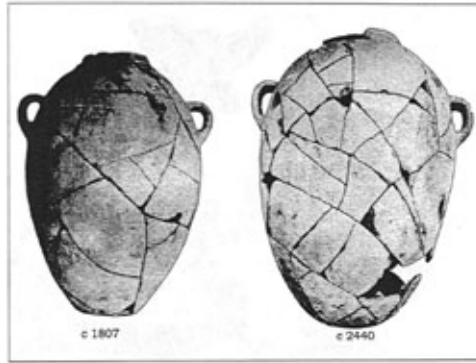

Grandes amphores, Alişar.
Echelle 1/8.
von der OSTEN, 1937, fig. 427.



Grande amphore, Alişar.
von der OSTEN, 1937, fig. 420.

Pl. 337. Amphore peinte, Alişar³³⁵.

³³⁵ von der OSTEN, 1928-29, 43.

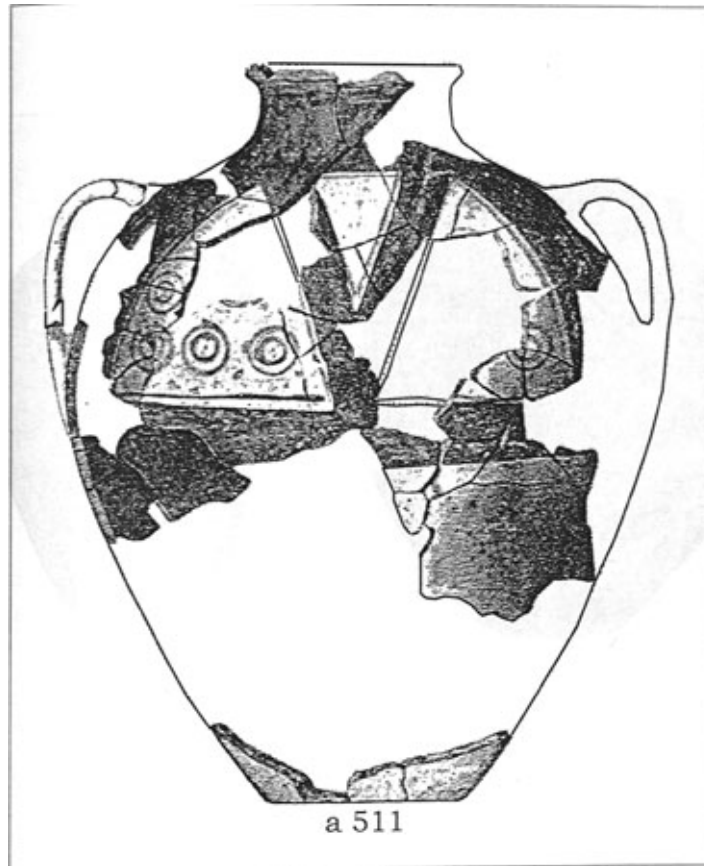

Pl. 338. Amphore et pithos, Alişar³³⁶.

³³⁶ von der OSTEN, 1928-29, 52.

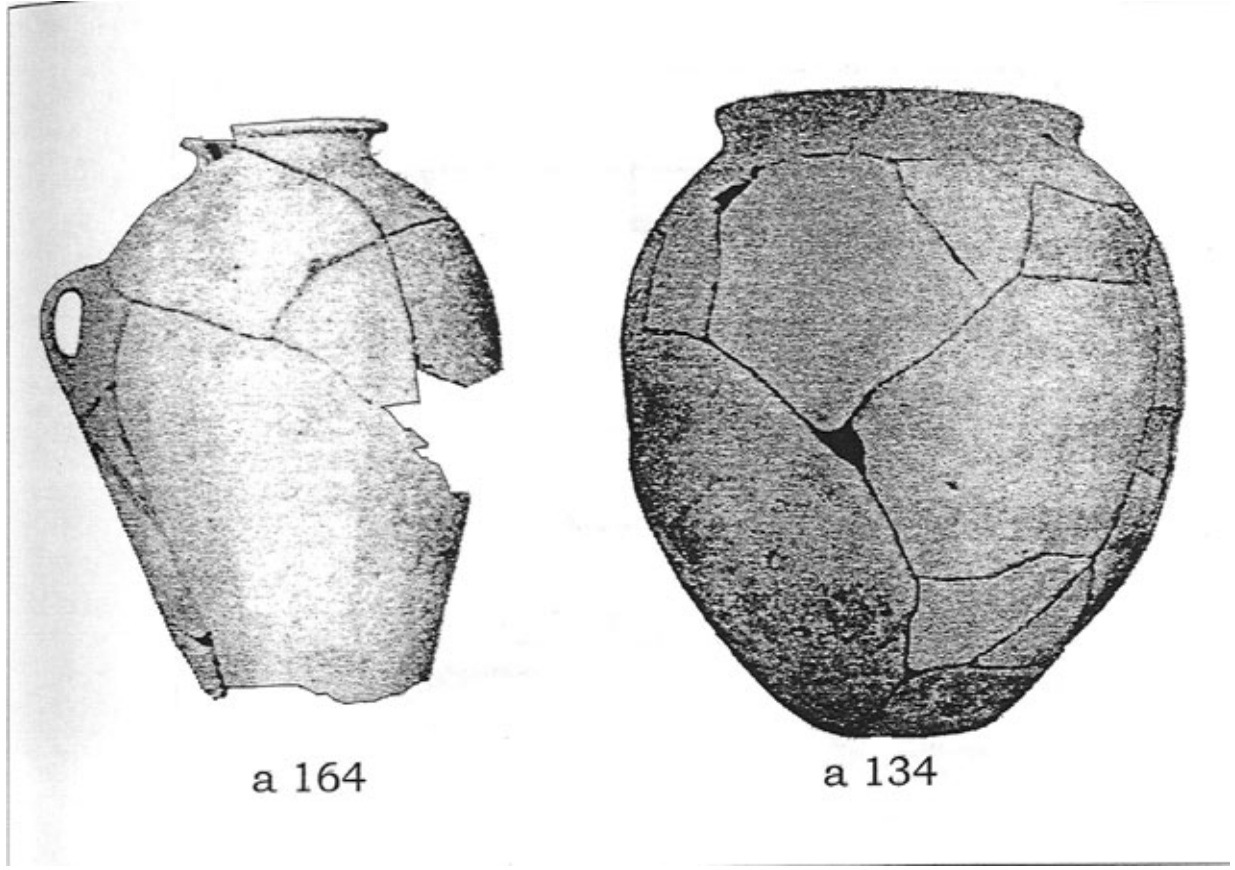

Pl. 339. Grandes jarres, Göllüdağ³³⁷.

³³⁷ TEZCAN, 1992, Resim 16-17.

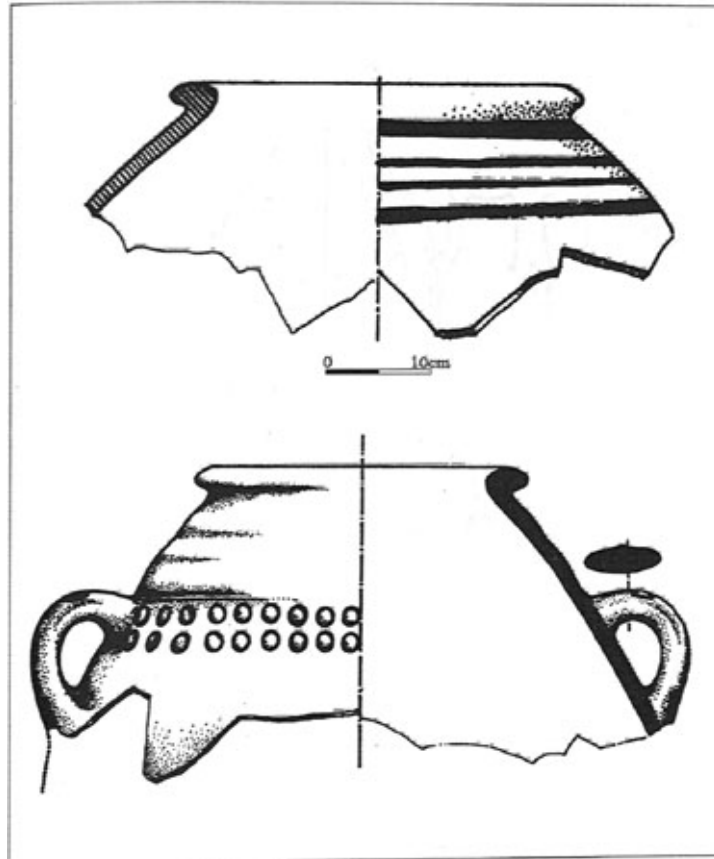

Pl. 340. Jarres à col cylindrique, Kaman³³⁸.

³³⁸ MIKAMI, OMURA, 1992, fig. 8. 1, 2.

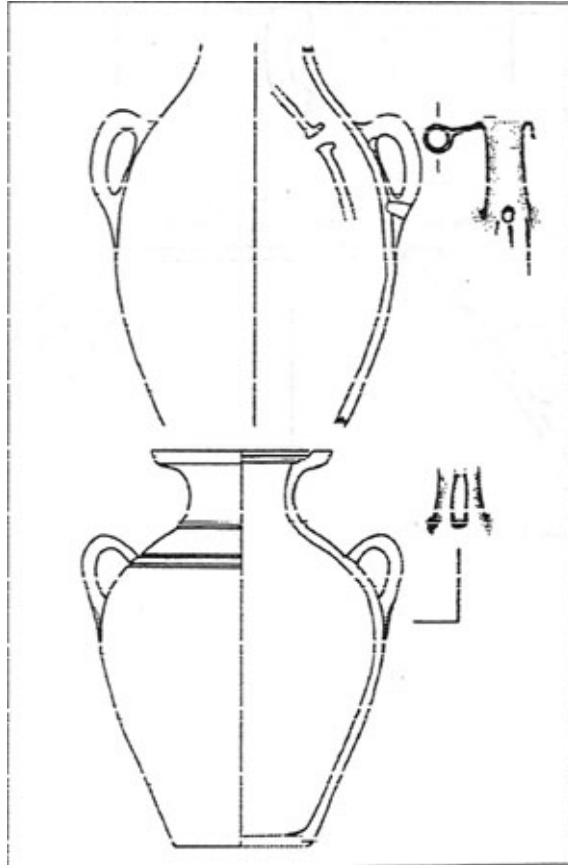

Pl. 341. Jarres à embouchure ronde à col cylindrique bas ou sans col, Kaman³³⁹.

³³⁹ OMURA, 1992, fig. 11.

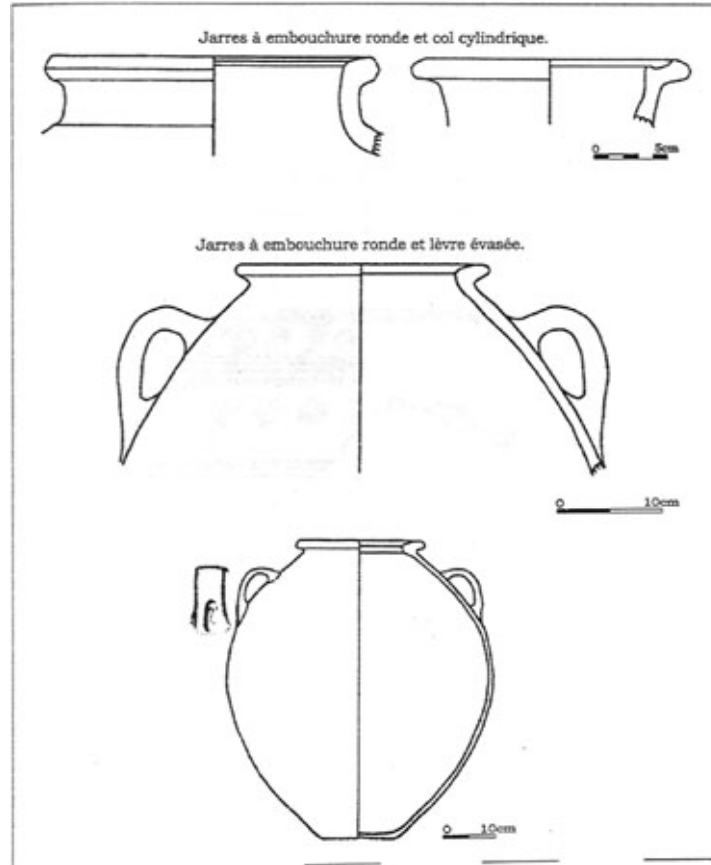

Pl. 342. Amphore à col cylindrique, Kültepe³⁴⁰.

³⁴⁰ ÖZGÜÇ, 1971, fig. 98.

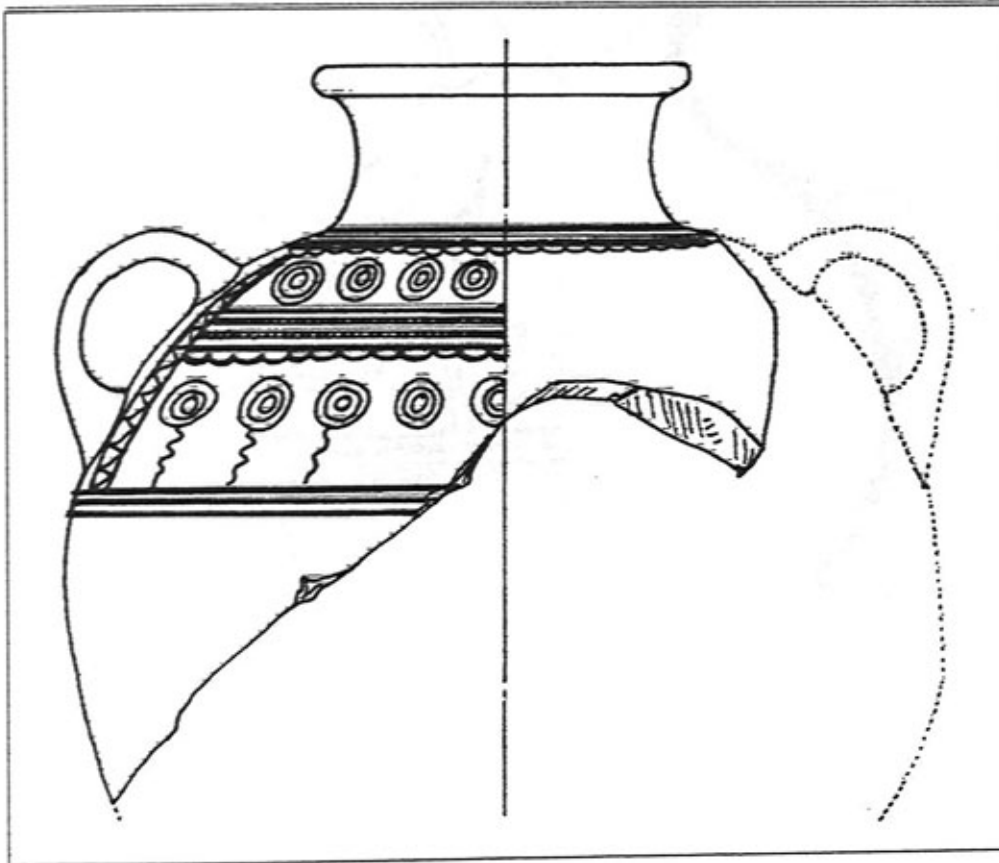

Pl. 343. Amphore à col cylindrique, Boğazköy³⁴¹.

³⁴¹ NEVE, 1969, 34.



Pl. 344. Jarre à col cylindrique, Kaman³⁴².

³⁴² OMURA, 1992, III-6.

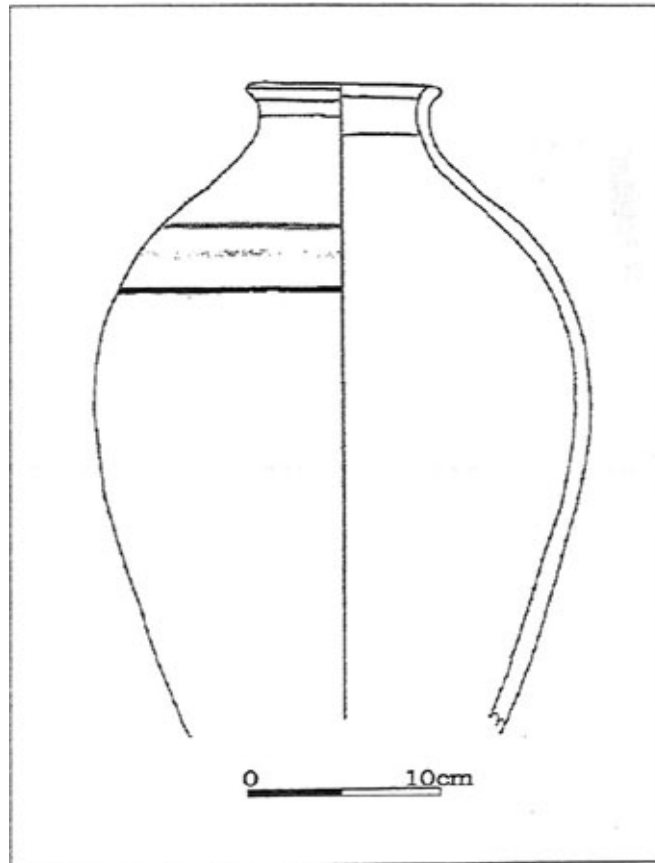

Pl. 345. Grands pots, niveau IV, Porsuk³⁴³.

³⁴³ DUPRE, 1983, pl. 52.

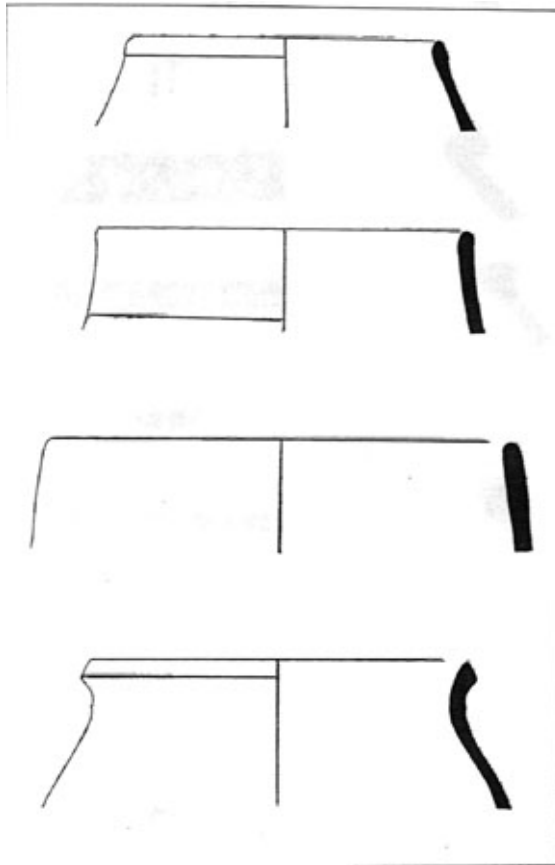

Pl. 346. Jarres à épaule convexe, série a, niveau IV, Porsuk³⁴⁴.

³⁴⁴ DUPRE, 1983, pl. 56.

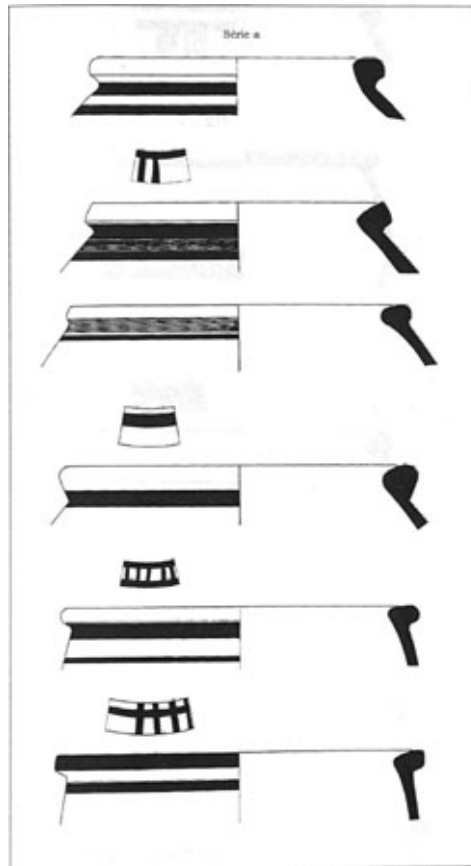

Pl. 347. Grandes jarres, séries a et b, Porsuk³⁴⁵.

³⁴⁵ DUPRE, 1983, pl. 57-58.

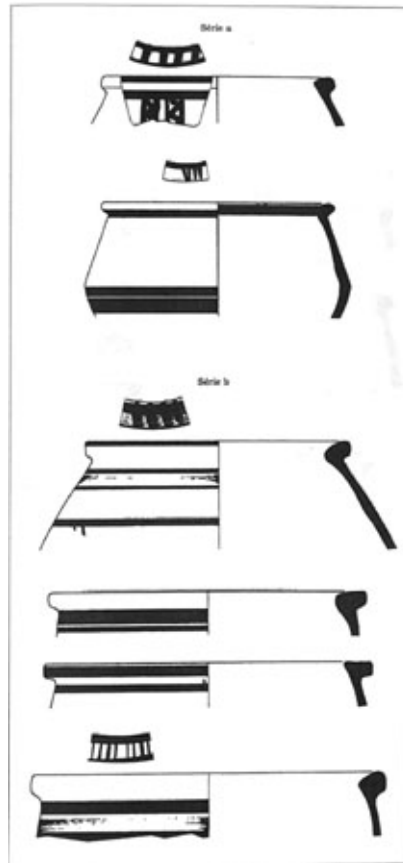

Pl. 348. Grandes jarres, Gordion³⁴⁶.

³⁴⁶ SAMS, 1994a, fig. 56.

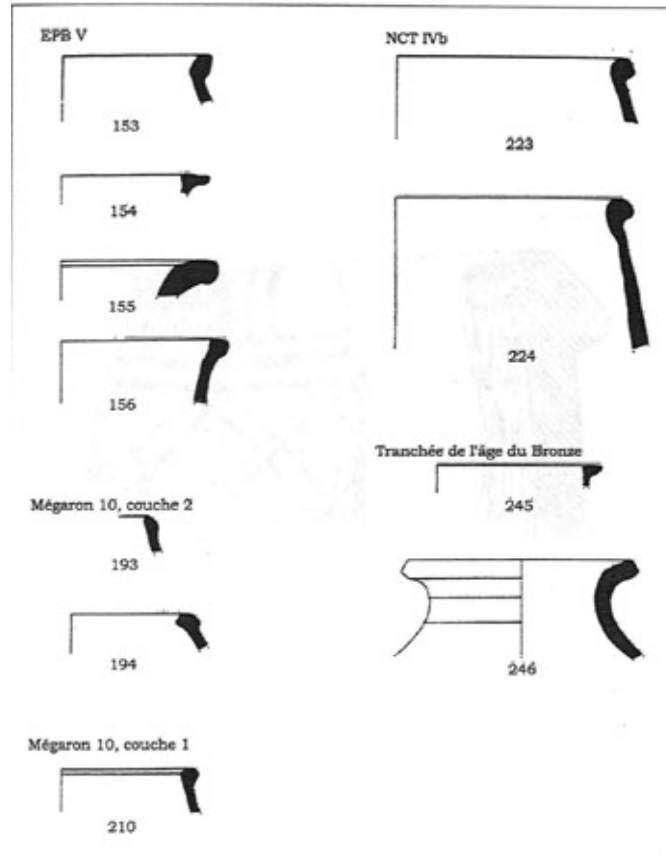

Pl. 349. Grande jarre à bord épaissi, Karahöyük³⁴⁷.

³⁴⁷ ÖZGÜÇ, 1949, Lev. XXVII. 1.

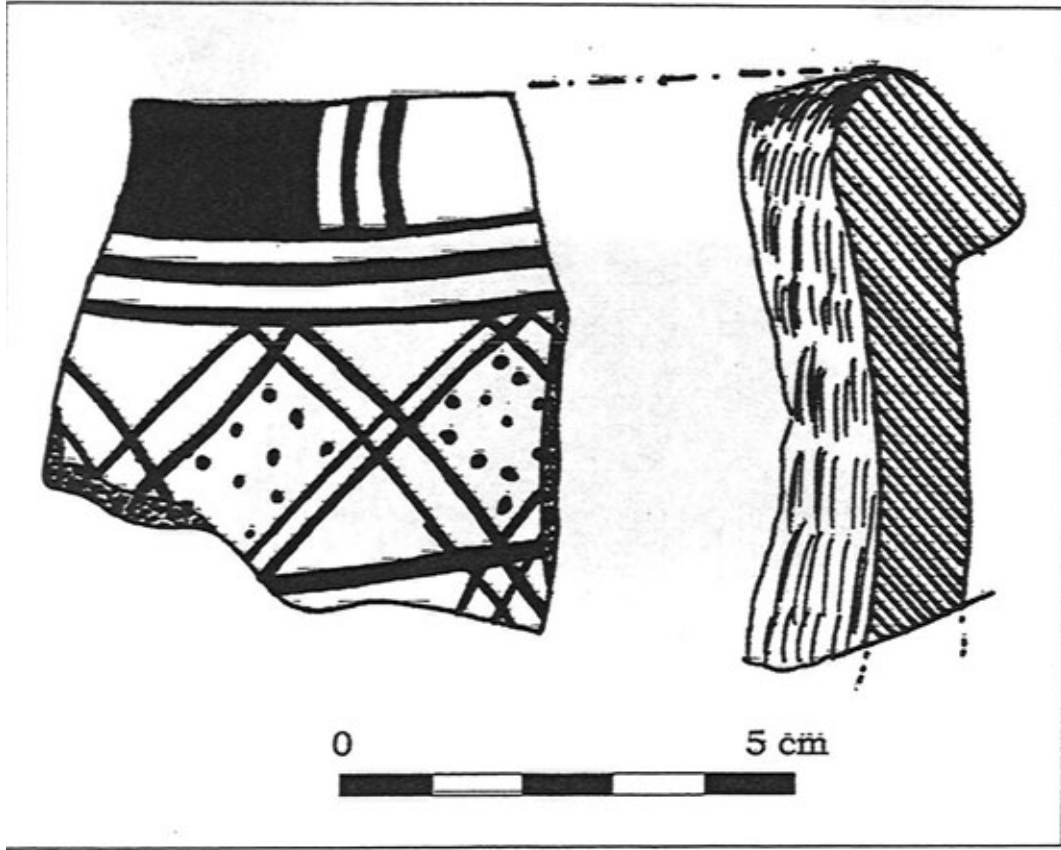

Pl. 350. Jarres de stockage, Alishar³⁴⁸.

³⁴⁸ ÖZGÜÇ, 1949, fig. 429.

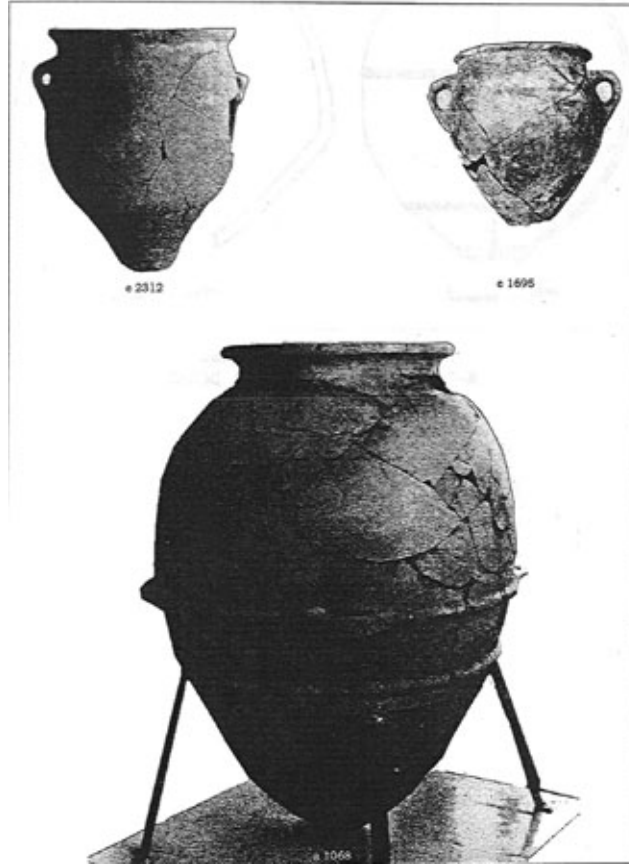

Pl. 351. Jarres de stockage, Kaman Kalehöyük, Hacibektaş³⁴⁹.

³⁴⁹ MORI, OMURA, 1993, fig. 10. 7-8. BALKAN, SÜMER, 1967, Res. 31.

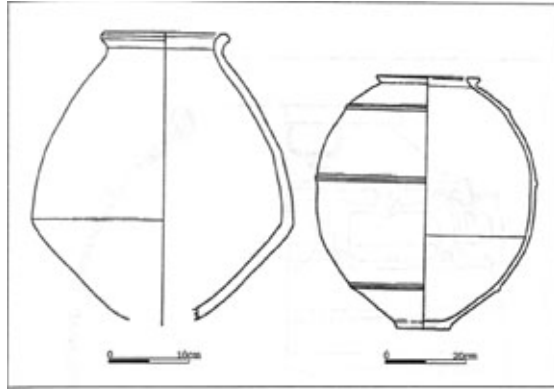

Jarres de stockage, Kaman.
MORI, OMURA, 1993, Fig. 10.7-8.



Jarre de stockage, Hacibektaş.
BALKAN, SÖMER, 1967, Res. 31.

Pl. 352. Jarre de stockage et détail des décors en relief, Porsuk³⁵⁰.

³⁵⁰ DUPRE, 1983, pl. 89.

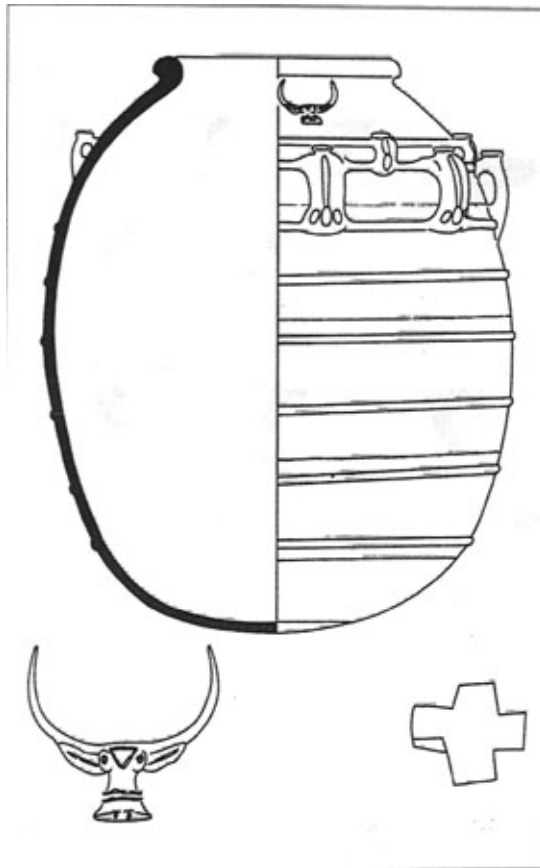

Pl. 353. Jarres de stockage, Gordion³⁵¹.

³⁵¹ SAMS, 1994a, fig. 50.

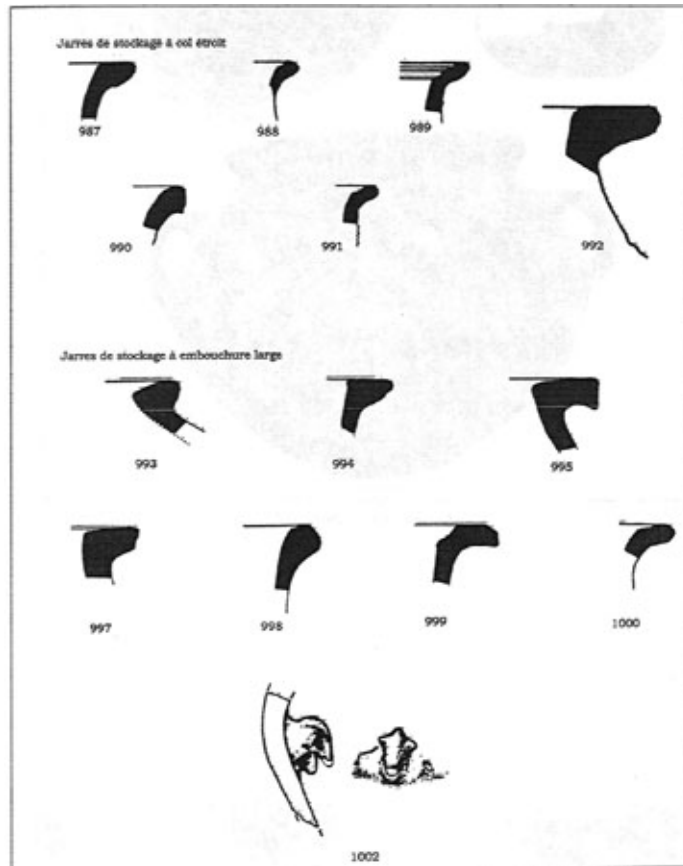

Pl. 354. Vaisselle de cuisine, Alişar, Karahöyük³⁵².

³⁵² von der OSTEN, 1937, fig. 428. ÖZGÜÇ, 1949, Lev. XXX.



Vases de cuisine, Alişar.
von der OSTEN, 1937, fig. 428.

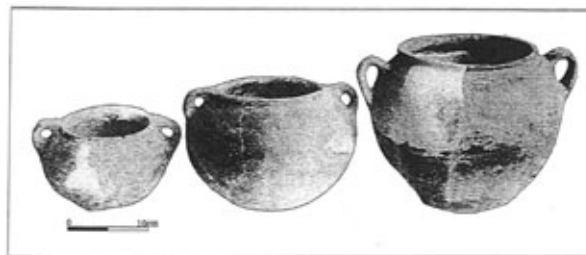

Vaisselle grossière, Karahöyük.
ÖZGÜÇ, 1949, lev. XXX.

Pl. 355. Vaisselle de cuisine, séries a et b, Porsuk³⁵³.

³⁵³ DUPRE, 1983, pl. 86-87.

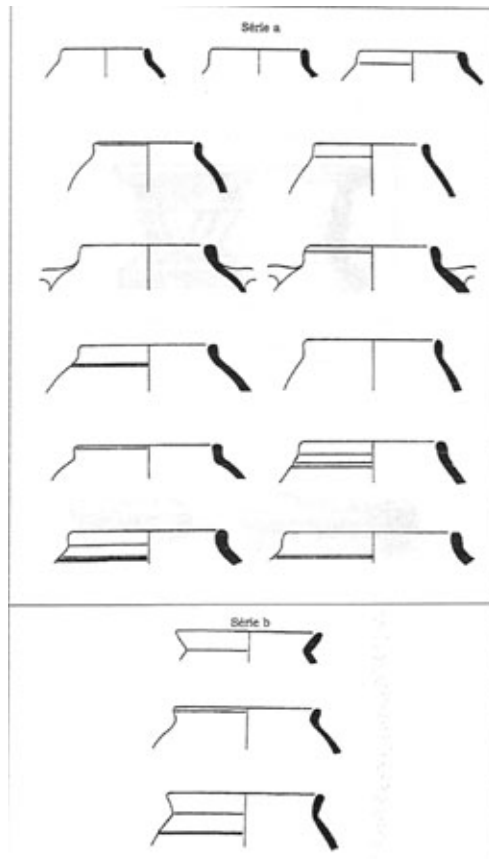

Pl. 356. Supports, Gordion, Porsuk³⁵⁴.

³⁵⁴ SAMS, 1994a, fig. 31. DUPRE, 1983, pl. 90.

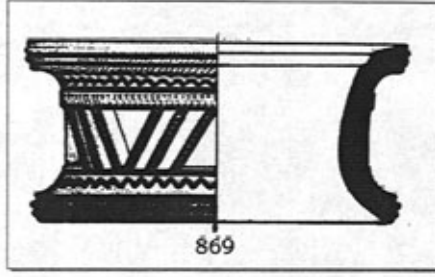

Support, Gordion.
SAMS, 1994a, fig. 31

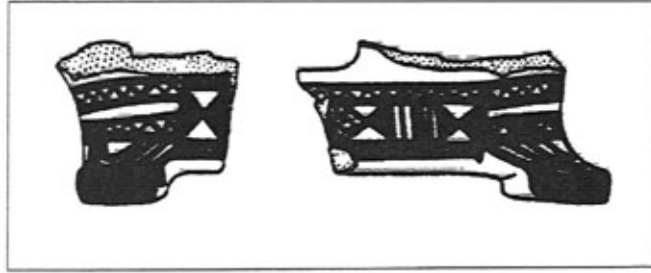

Trépid, Porsuk.
DUPRE, 1983, pl. 90.

Pl. 357. Support, Kültepe³⁵⁵.

³⁵⁵ ÖZGÜÇ, 1971, pl. XXVII. fig. 99.

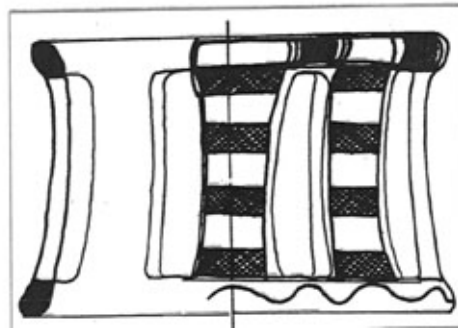
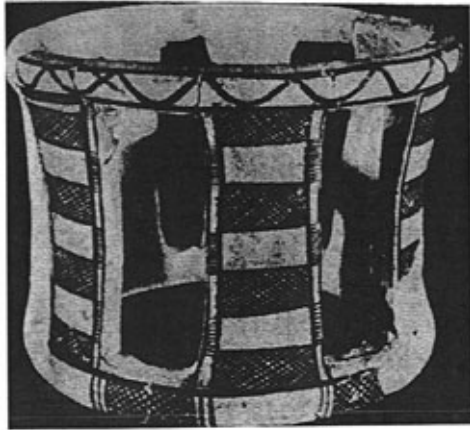

Pl. 358. Bouteilles, Alişar³⁵⁶.

³⁵⁶ von der OSTEN, 1928-29, fig. 59-60 ; 1937, fig. 417.

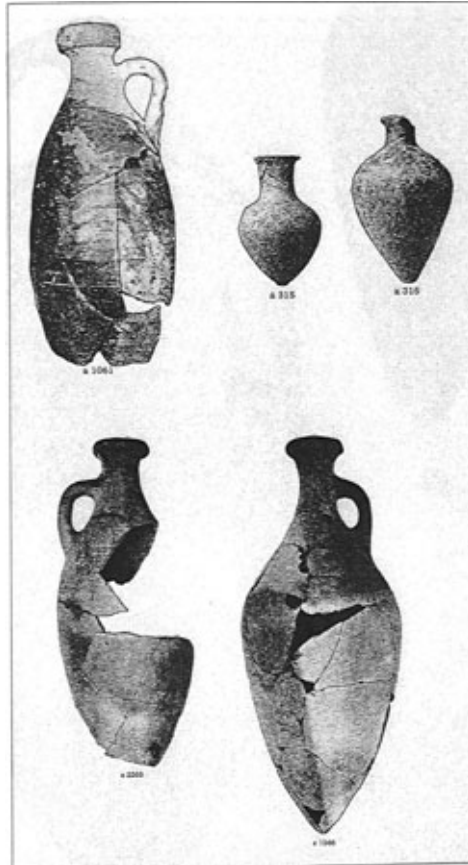

Pl. 359. Bouteilles-amphores, Alişar³⁵⁷.

³⁵⁷ von der OSTEN, 1937, fig. 416.

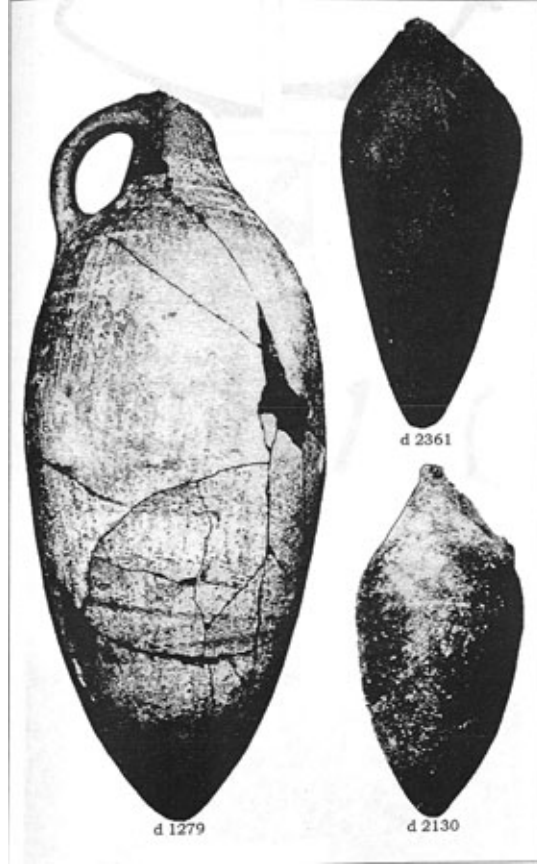

Pl. 360. Bols, anses, urne, bouteille et vase zoomorphe, Büyük Güllücek³⁵⁸.

³⁵⁸ KOŞAY, 1957, Taf. VIII.

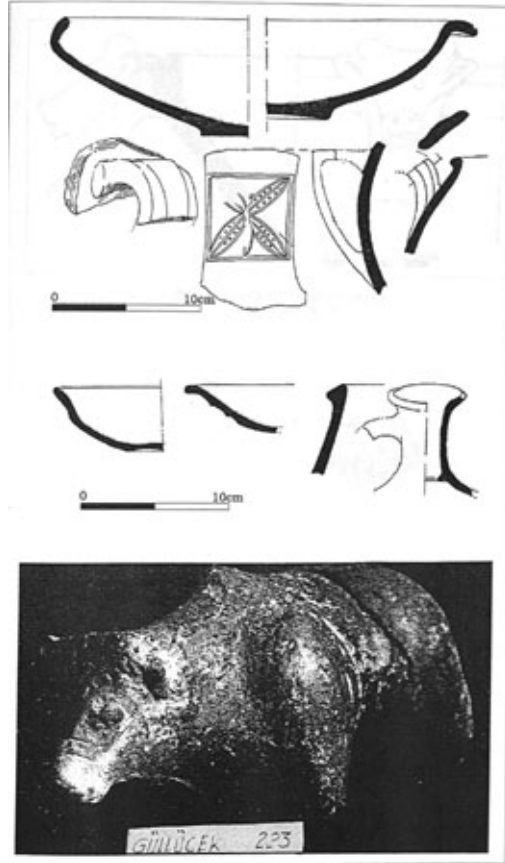

Pl. 361. Vases à décor zoomorphe, Maşat, Boğazköy³⁵⁹.

³⁵⁹ ÖZGÜÇ, 1982, fig. M. BITTEL, 1970, 141.

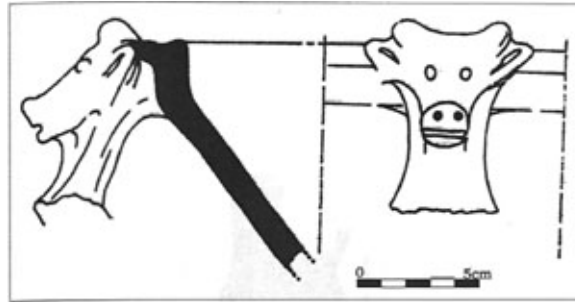

Boi à décor de taureau, Maşat Höyük.
ÖZGÜÇ, 1982, fig. M.

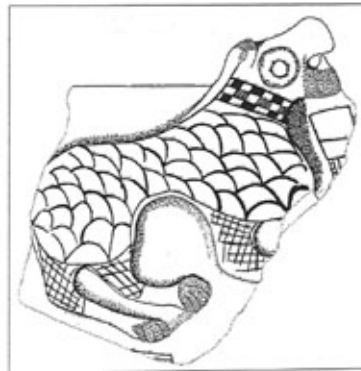

Vase à décor de lion, Boğazköy.
BITTEL, 1970, 141.

Pl. 362. Askos et vase zoomorphe, Gordion, Porsuk³⁶⁰.

³⁶⁰YOUNG, 1960, pl. 58. DUPRE, 1983, pl. 58.



Askos, Gordion.
YOUNG, 1960, pl. 58.

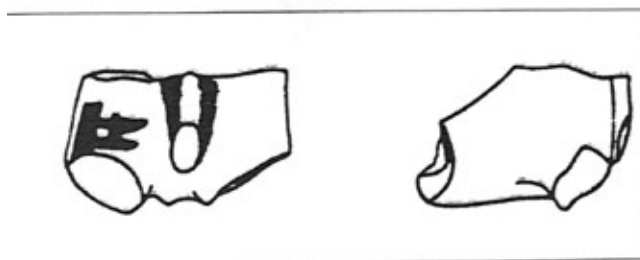

Vase zoomorphe, Porsuk
DUPRE, 1983, P158.

Pl. 363. Askos et décors zoomorphes, Alishar, Kültepe³⁶¹.

³⁶¹ von der OSTEN, 1928-29, fig. 57-58. ÖZGÜÇ, 1971, Pl. XXVII.5, fig.167.

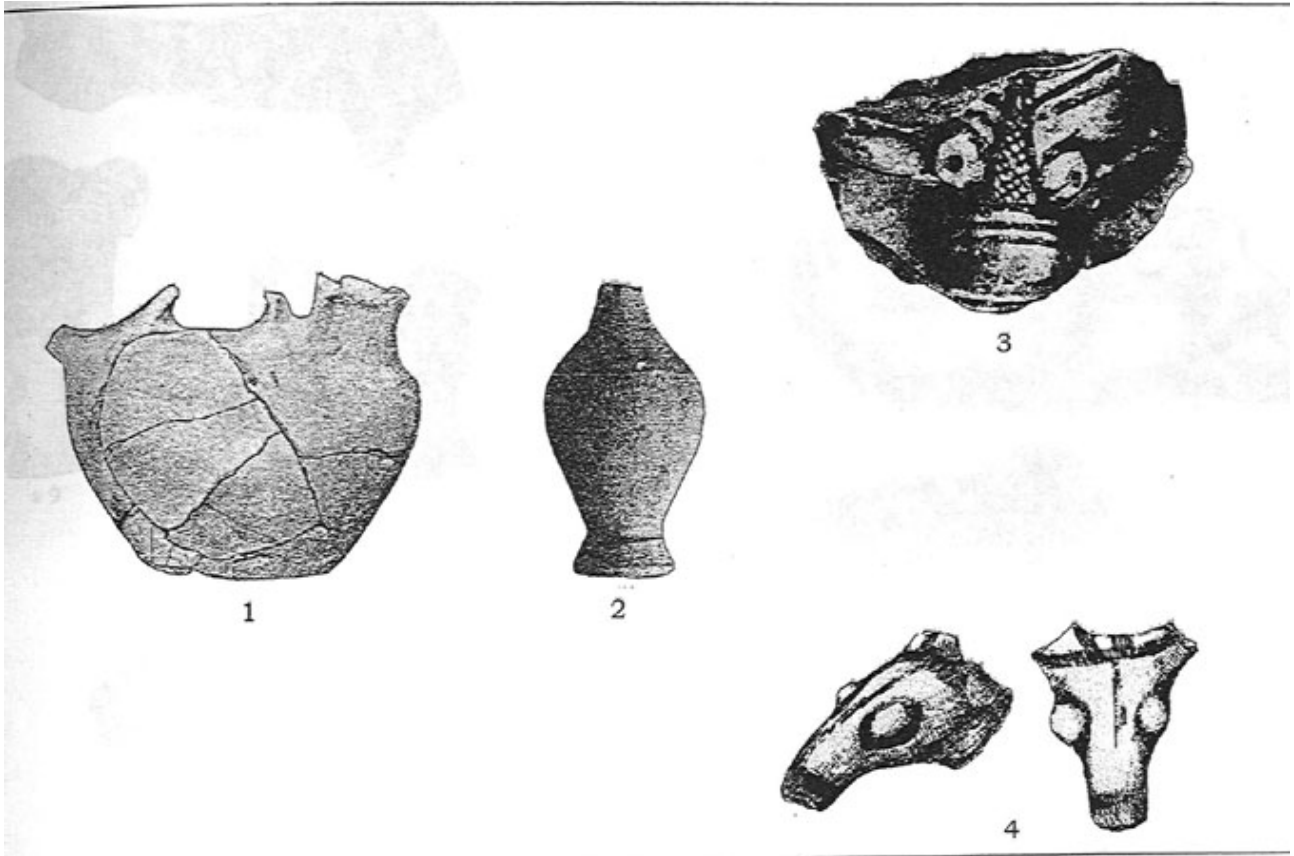

Pl. 364. Vases à décors zoomorphes, Alishar³⁶².

³⁶² von der OSTEN, 1928-29, 62-63.

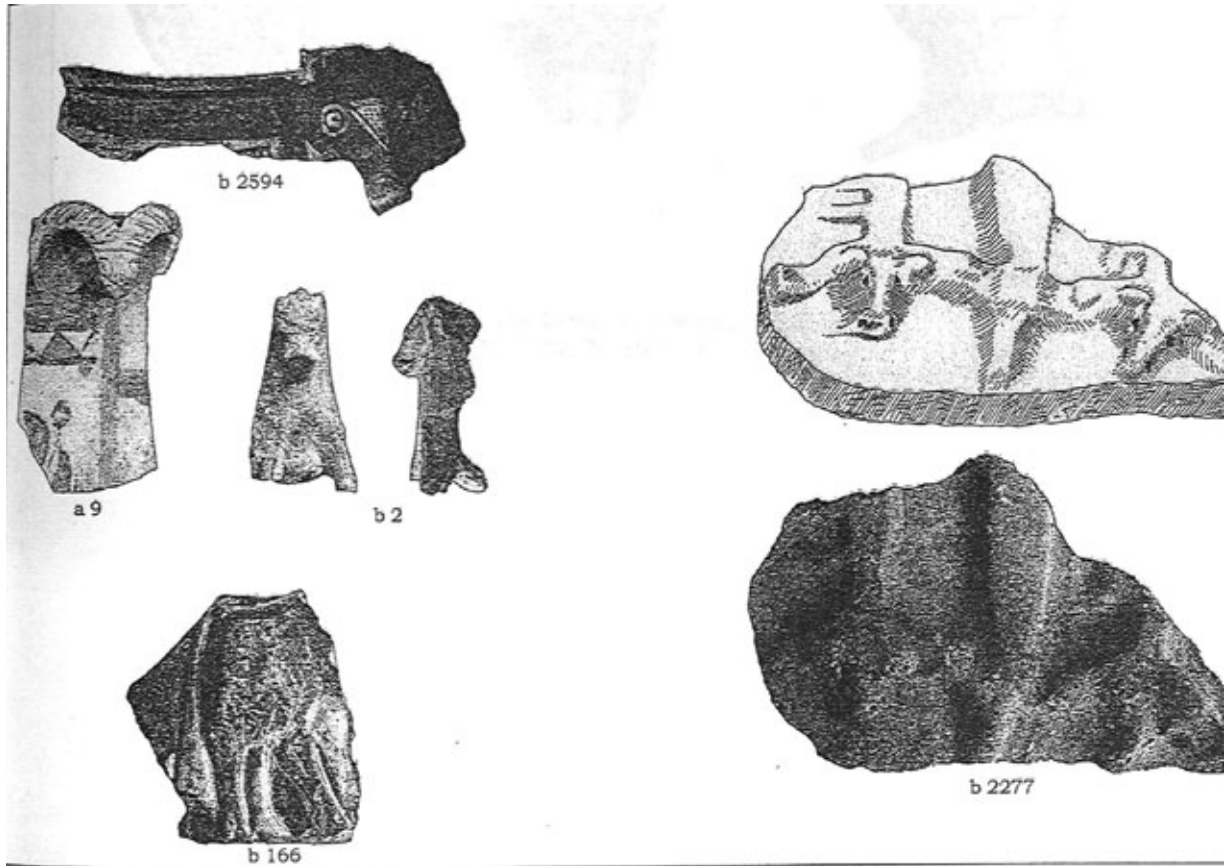

Pl. 365. Décors de vases, Boğazköy, Kululu³⁶³.

³⁶³ SCHIRMER, 1969, fig. 163-165. ÖZGÜÇ, 1971, 40.

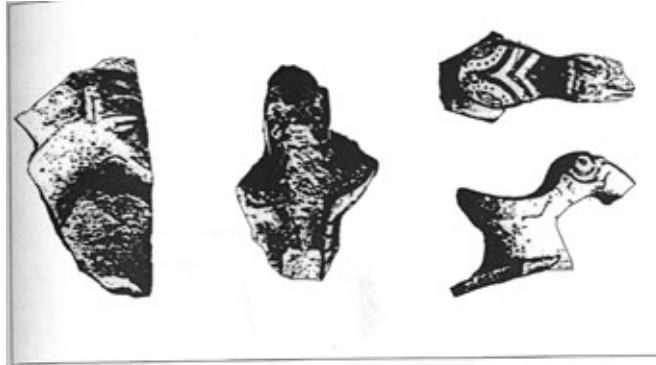

Fragments de vases zoomorphes, Boğazköy.
SCHIRMER, 1969, fig. 163-165.

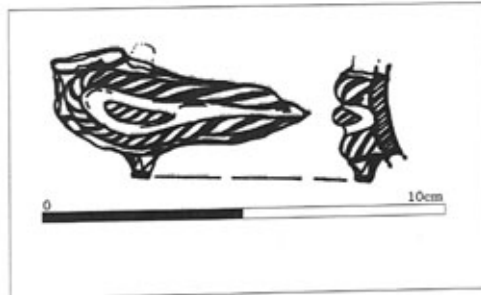

Décor zoomorphe de vase, Kuluha.
ÖZÖC, 1971, 40.

Pl. 366. Rythons, Gordion³⁶⁴.

³⁶⁴ SAMS, 1994a, fig. 32.

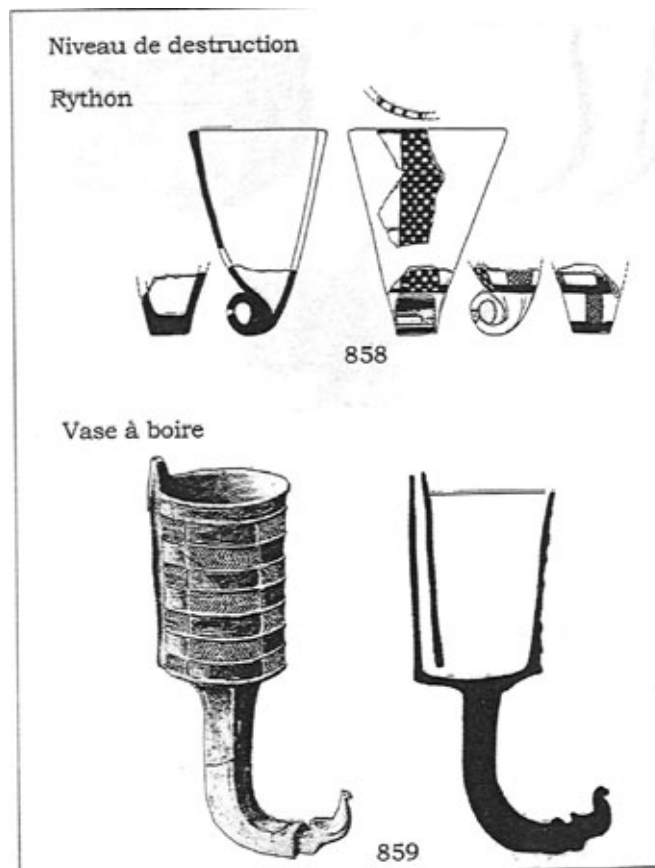

Pl. 367. Vases particuliers, Gordion³⁶⁵.

³⁶⁵ SAMS, 1994a, fig. 33.

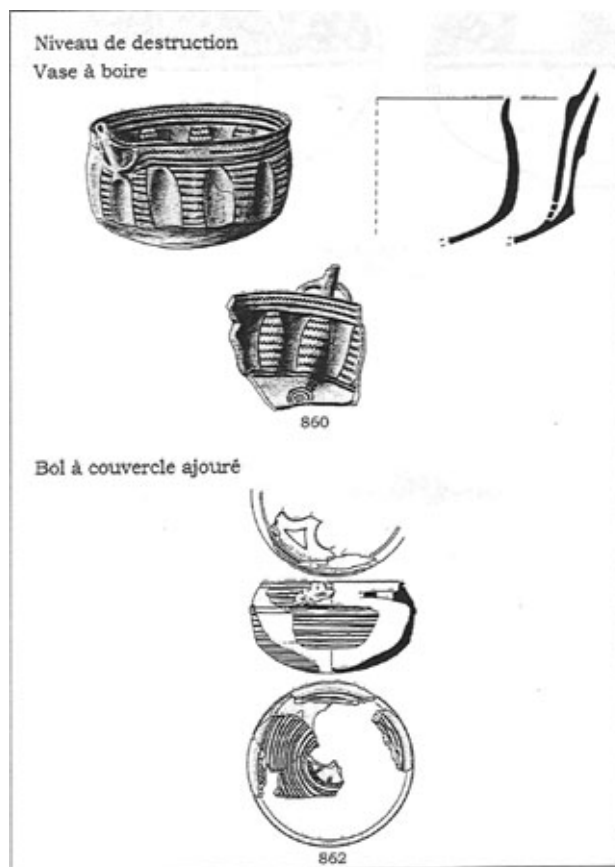

Pl. 368. Vases particuliers, Gordion, Kültepe³⁶⁶.

³⁶⁶ SAMS, 1994a, fig. 28. ÖZGÜÇ, 1971, pl. XXVII. 3-4.

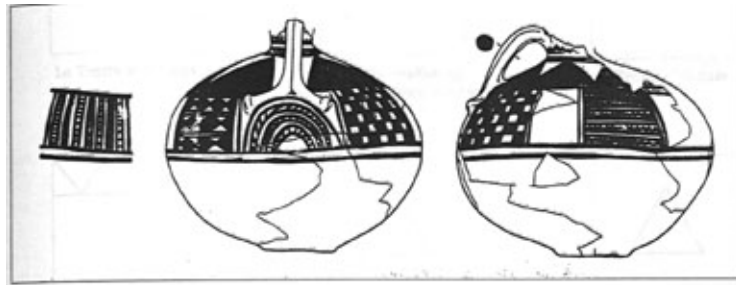

Jarre, Gordion.
SAMS, 1994a, fig. 28.



Urne à col haut placée dans une structure (1), plaque de céramique peinte (2), Kültepe.
ÖZGÜÇ, 1971, pl. XXVII. 3-4.

Pl. 369. Motifs peints.

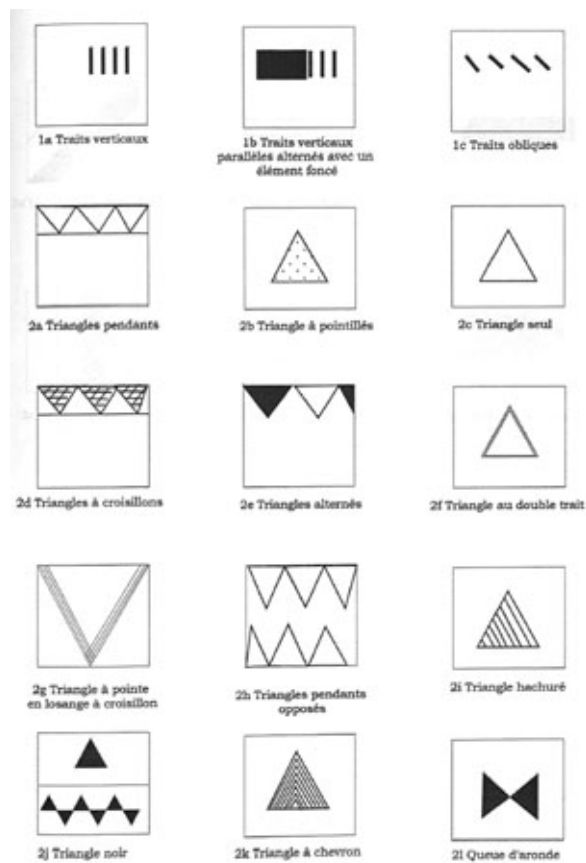

Pl. 370. Motifs peints.

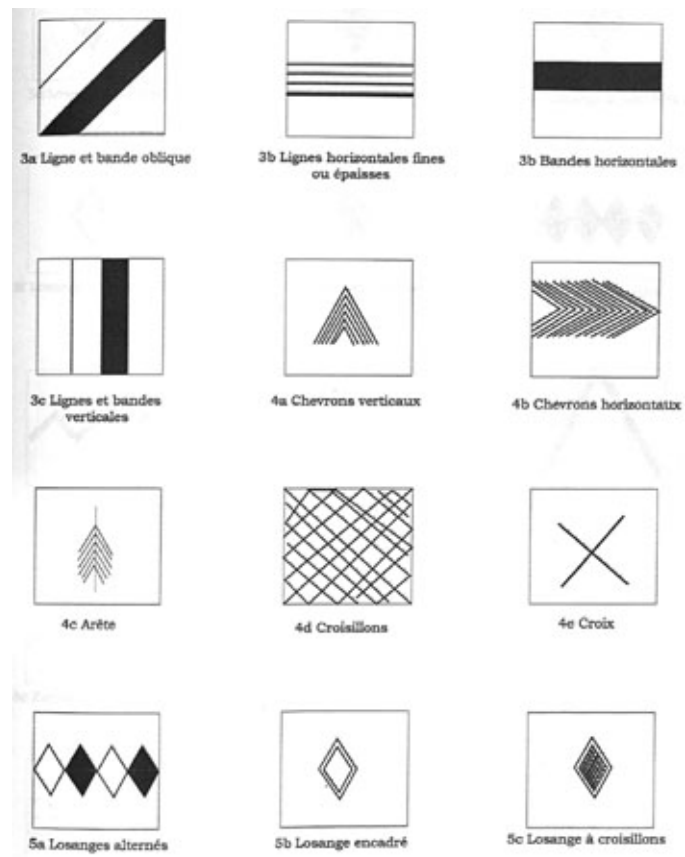

Pl. 371. Motifs peints.

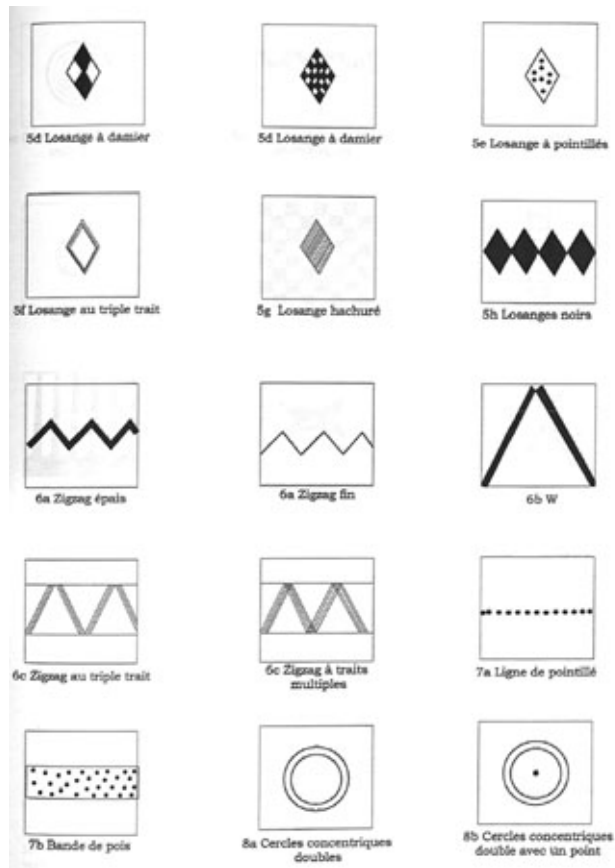

Pl. 372. Motifs peints.

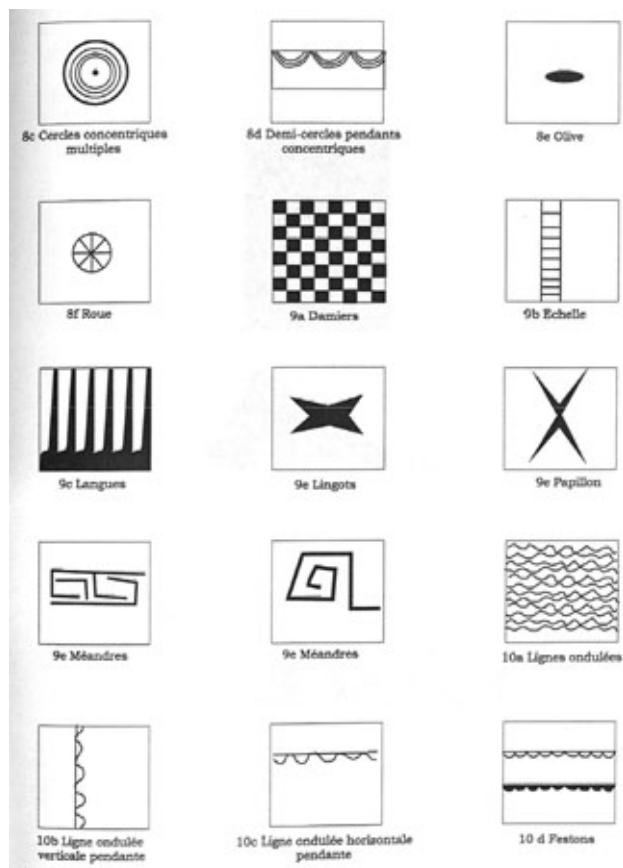

Pl. 373. Motifs, Eskiyapar³⁶⁷.

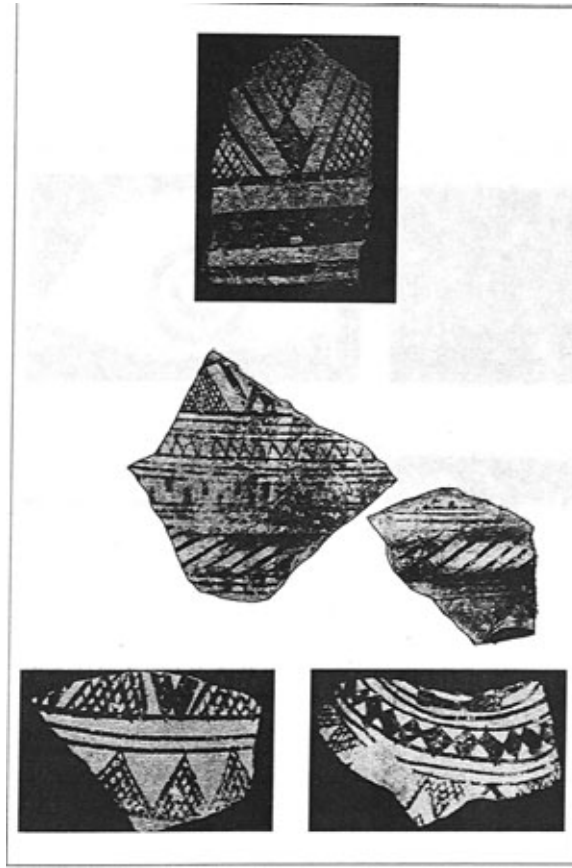

Pl. 374. Tessons peints, Eskiyapar³⁶⁸.

³⁶⁷ BAYBURTLUOĞLU, 1976, Res. 8-11.

³⁶⁸ BAYBURTLUOĞLU, 1976, Res. 12-15.

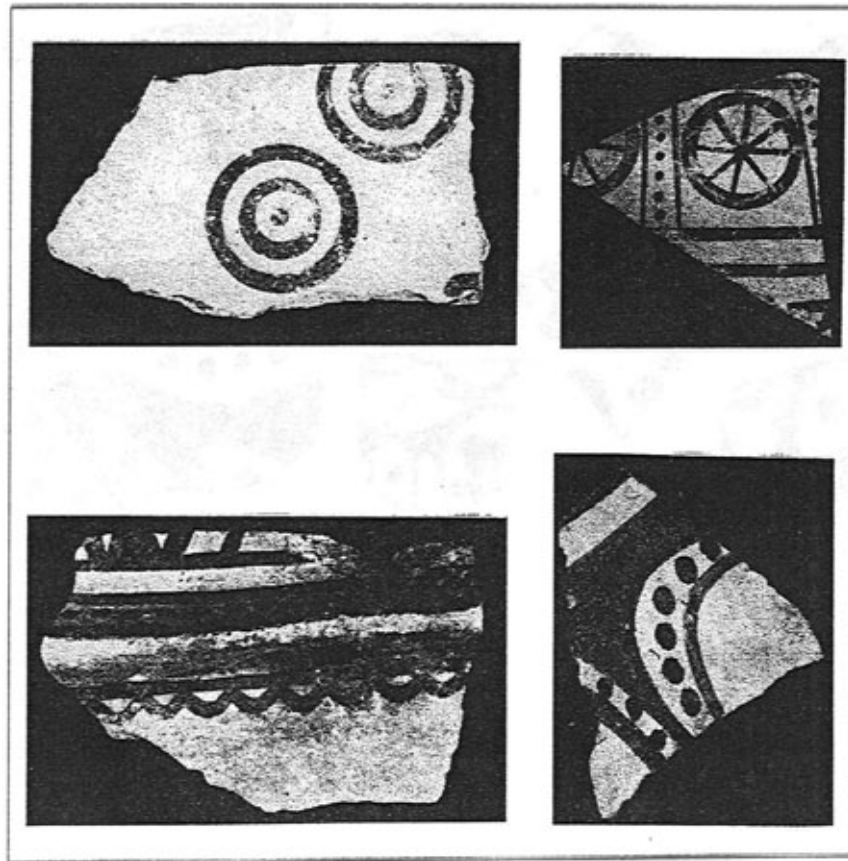

Pl. 375. Motifs de cervidés et de cercles concentriques, Alişar³⁶⁹.

³⁶⁹ von der OSTEN, 1928-29, Pl. XXXV.



Pl. 376. Motifs peints, Alişar³⁷⁰.

³⁷⁰ von der OSTEN, 1937, fig. 445.



Pl. 377. Motifs peints, Alişar³⁷¹.

³⁷¹ von der OSTEN, 1928-29, pl. XXXVI.

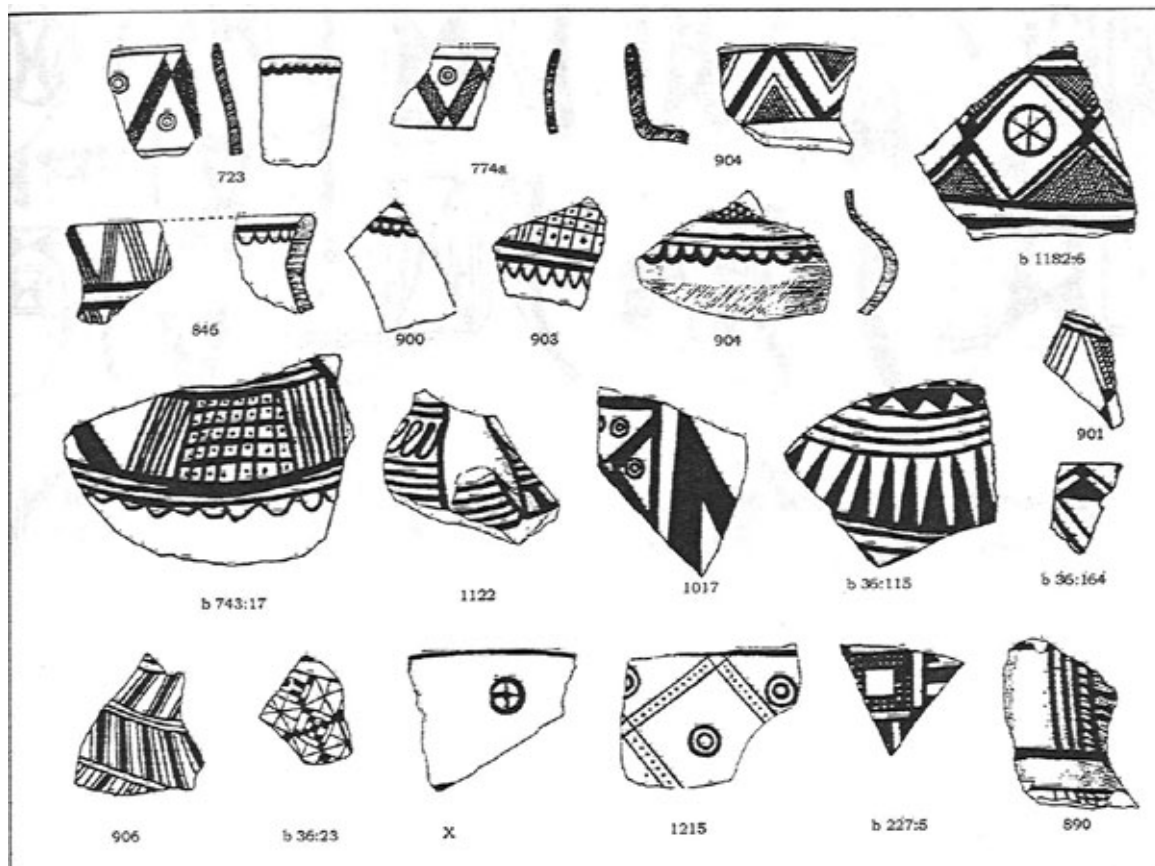

Pl. 378. Motifs sur des anses, Alişar³⁷².

³⁷² von der OSTEN, 1937, fig. 453-456.

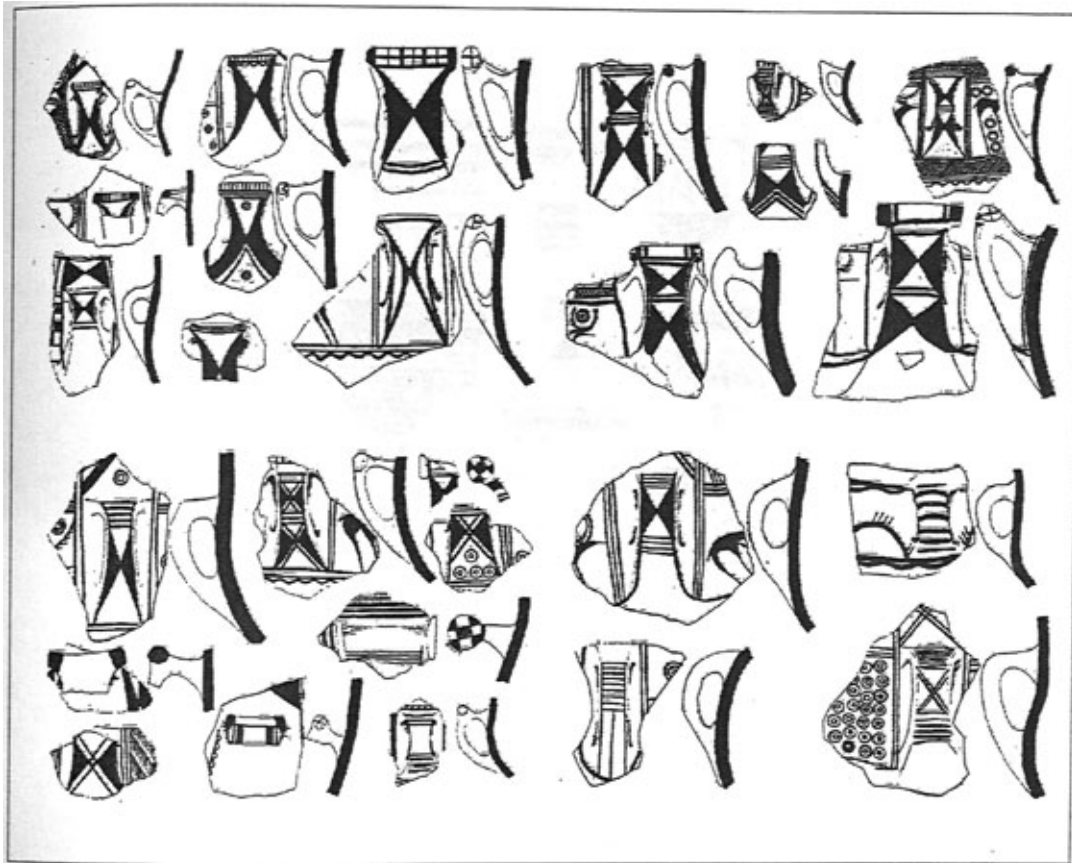

Pl. 379. Motifs sur le bord de grands vases, Alişar³⁷³.

³⁷³ von der OSTEN, 1937, fig. 452.



Pl. 380. Motifs trichromes, Alişar³⁷⁴.

³⁷⁴ von der OSTEN, 1928-29, pl. XXXIII.

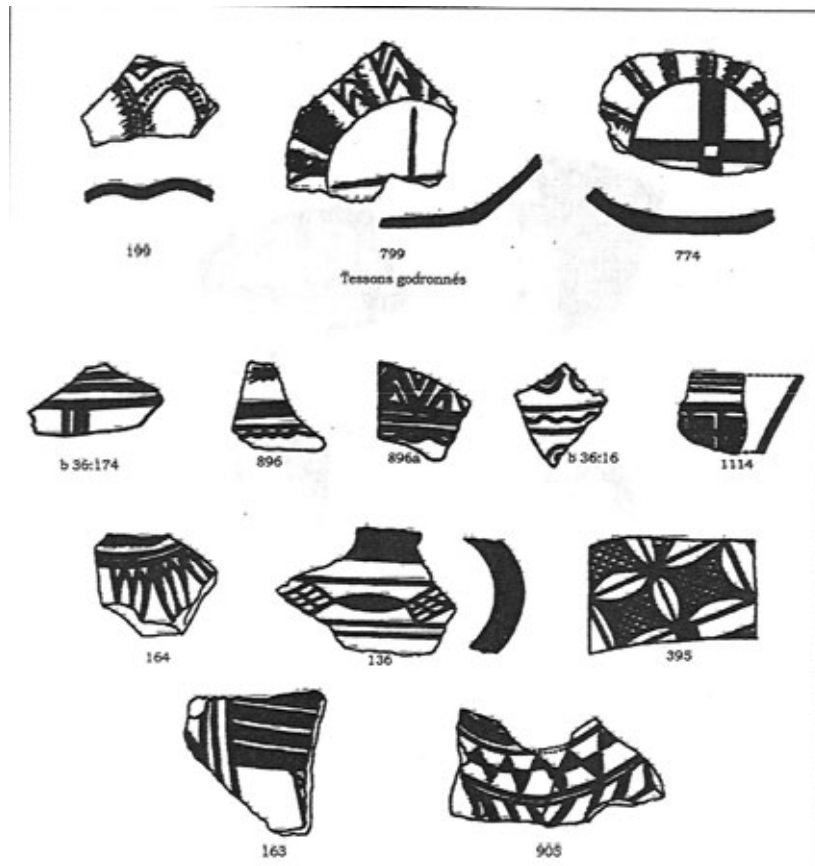

Pl. 381. Décors, Alişar³⁷⁵.

³⁷⁵ von der OSTEN, 1937, fig. 419.

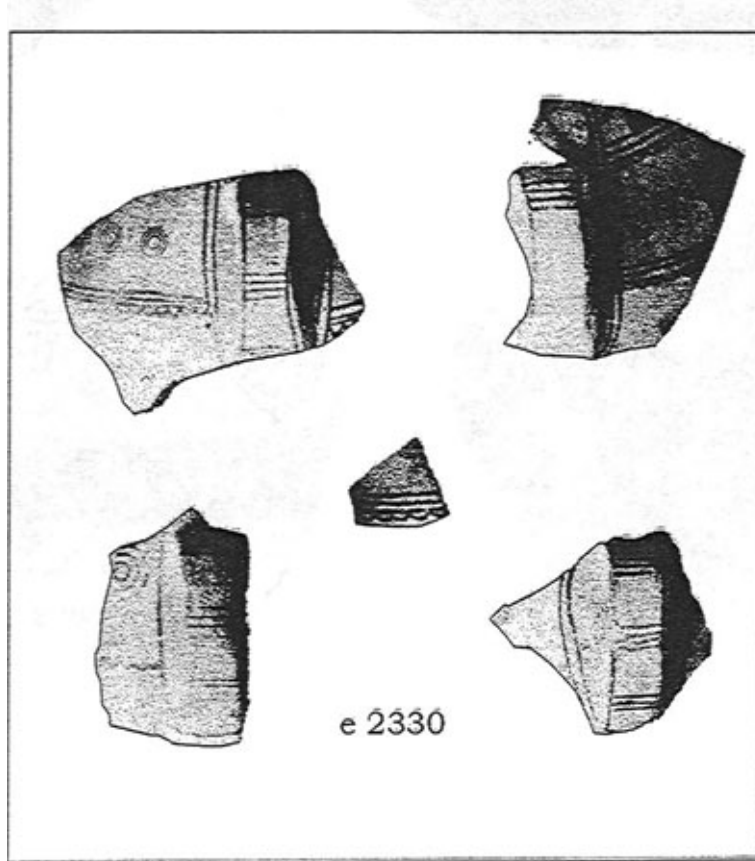

Pl. 382. Motifs peints, Maşat Höyük³⁷⁶.

³⁷⁶ ÖZGÜÇ, 1978, pl. 79.



Pl. 383. Décor de formes ouvertes, Maşat³⁷⁷.

³⁷⁷ ÖZGÜÇ, 1982, fig. I.

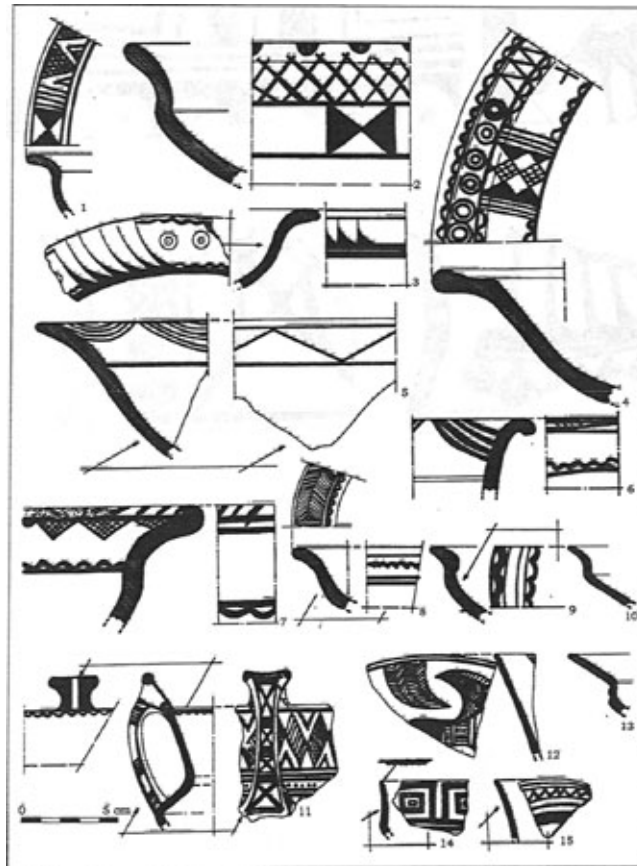

Pl. 384. Motifs peints, Sultanhan³⁷⁸.

³⁷⁸ EMRE, 1971, fig. 31-36.

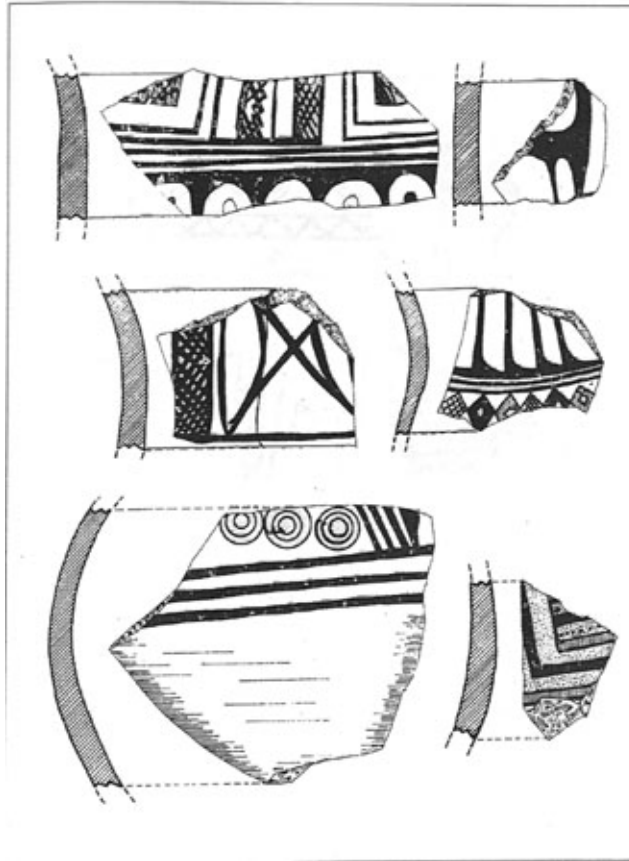

Pl. 385. Motifs peints, Sultanhan³⁷⁹.

³⁷⁹ EMRE, 1971, fig. 37-42.

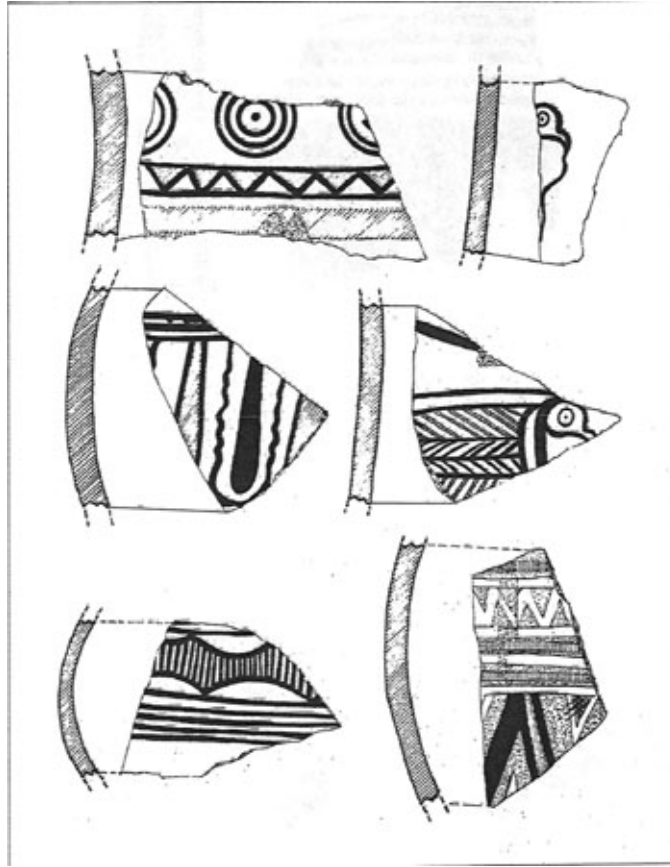

Pl. 386. Motifs peints, Sultanhan, Kültepe³⁸⁰.

³⁸⁰ EMRE, 1971, fig. 92. ÖZGÜÇ, 1971, pl. XVI.

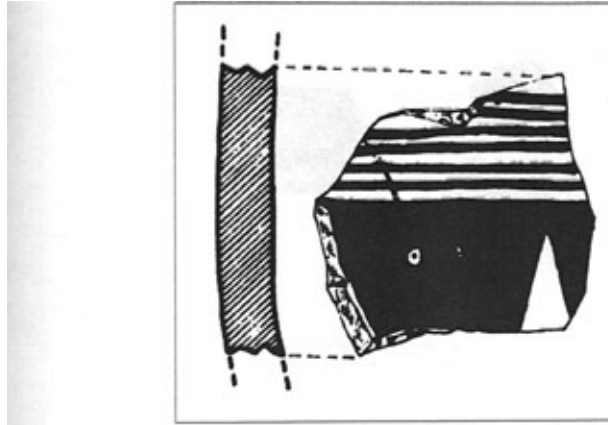

Lignes parallèles et triangle, Sultanhan.
EMRE, 1971, fig. 92.

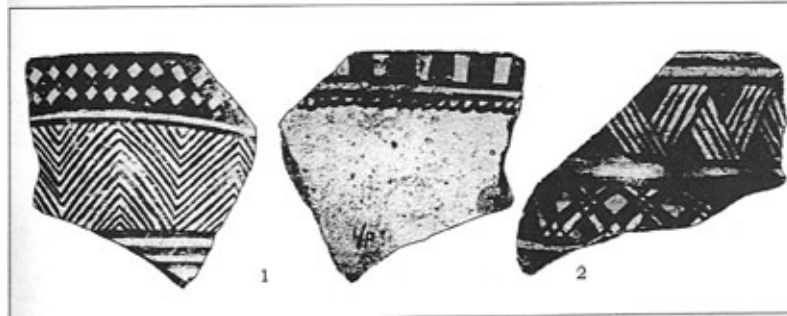

Pl. 387. Motifs, Hacibektaş³⁸¹.

³⁸¹ BALKAN, SÜMER, 1967, Res. 18-22.

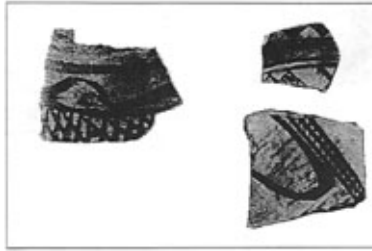

Motifs, Hacibektaş.
BALKAN, SÜMER, 1967, Res. 18-20.



Motifs, Hacibektaş.
BALKAN, SÜMER, 1967, Res. 18-20.

Pl. 388. Motifs peints, Kaman³⁸².

³⁸² OMURA, 1992, 74. 1-5, 7-8.

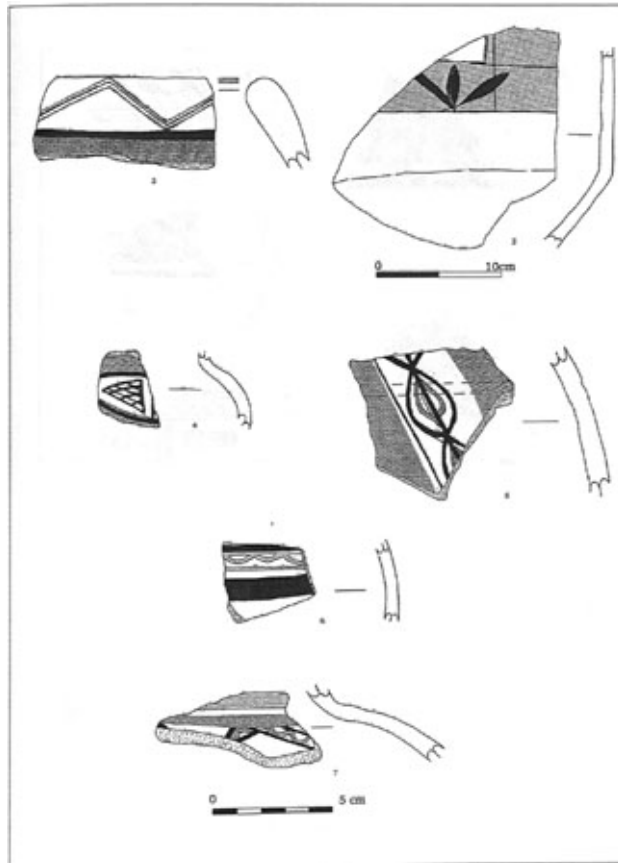

Pl. 389. Motifs peints, Kaman³⁸³.

³⁸³ OMURA, 1992, 72.

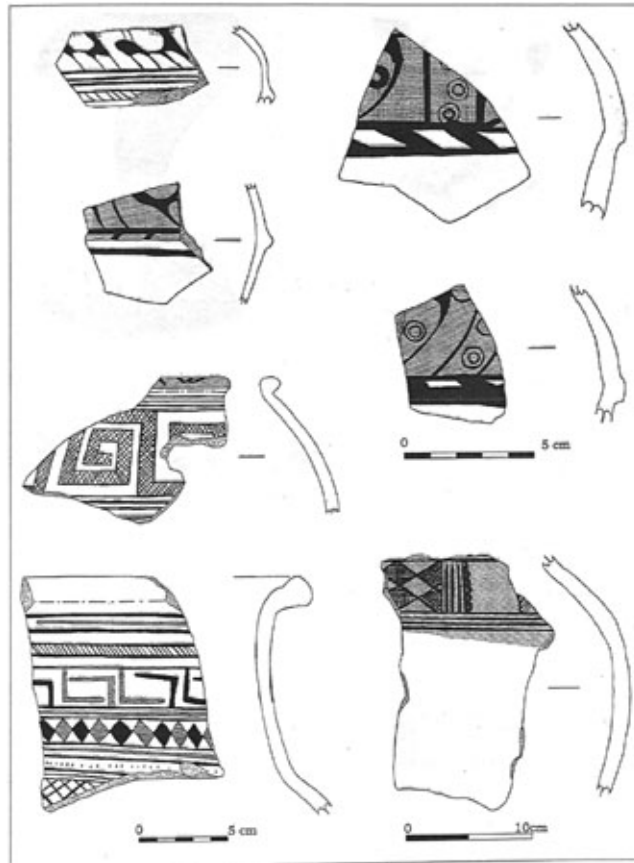

Pl. 390. Motifs peints, Kaman³⁸⁴.

³⁸⁴ OMURA, 1992, 73.



Pl. 391. Motifs peints, Kaman³⁸⁵.

³⁸⁵ OMURA, 1992, fig. 14.5-10.

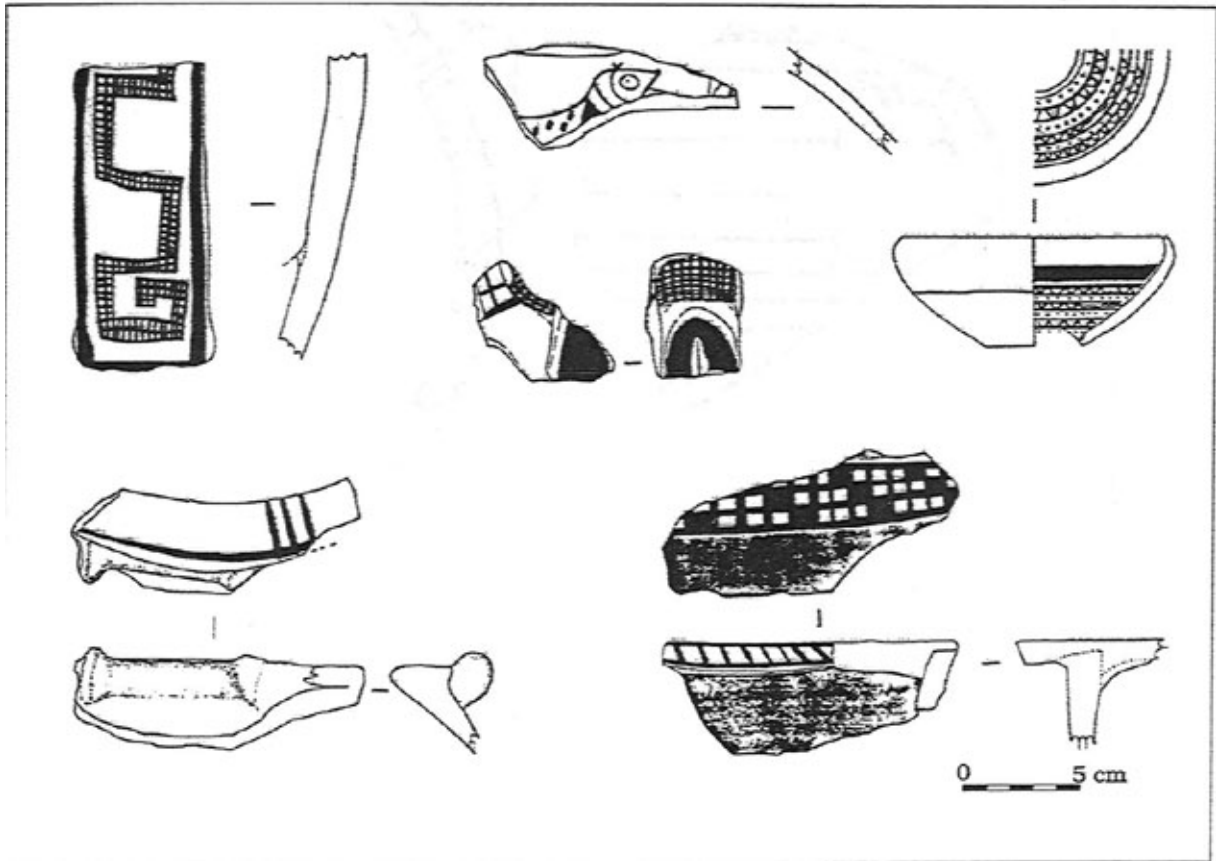

Pl. 392. Tessons décorés de cannelures et d'incisions, Küçük Höyük³⁸⁶.

³⁸⁶ ÖZKAN, 1990, fig. 35-37.

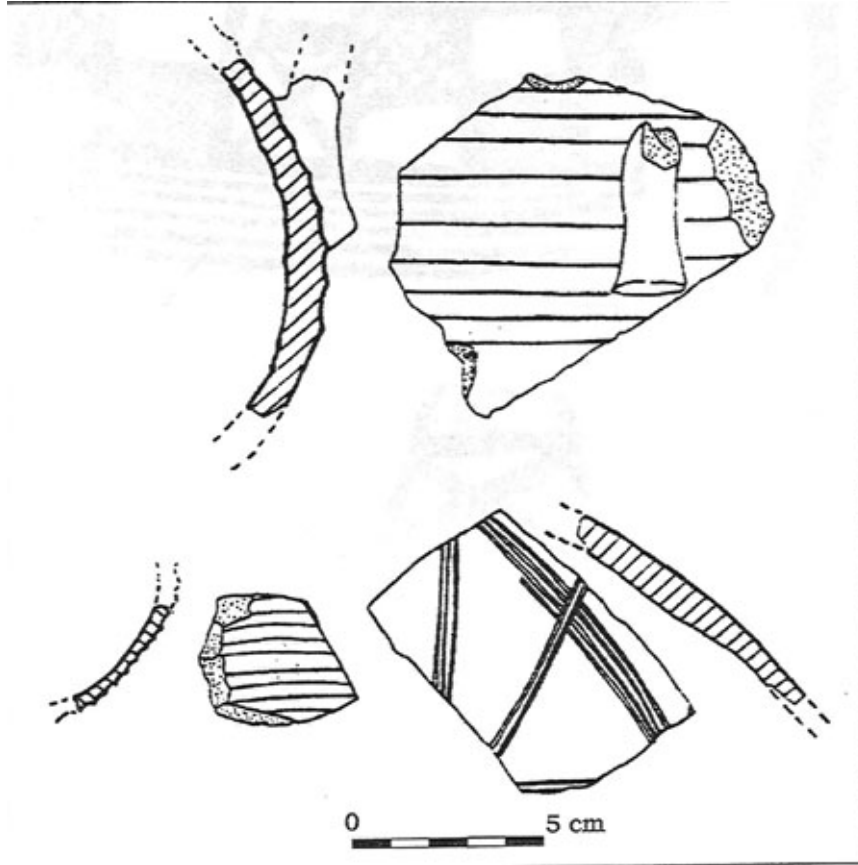

Pl. 393. Motifs peints, Göllüdağ³⁸⁷.

³⁸⁷ TEZCAN, 1992, Resim 5-6.

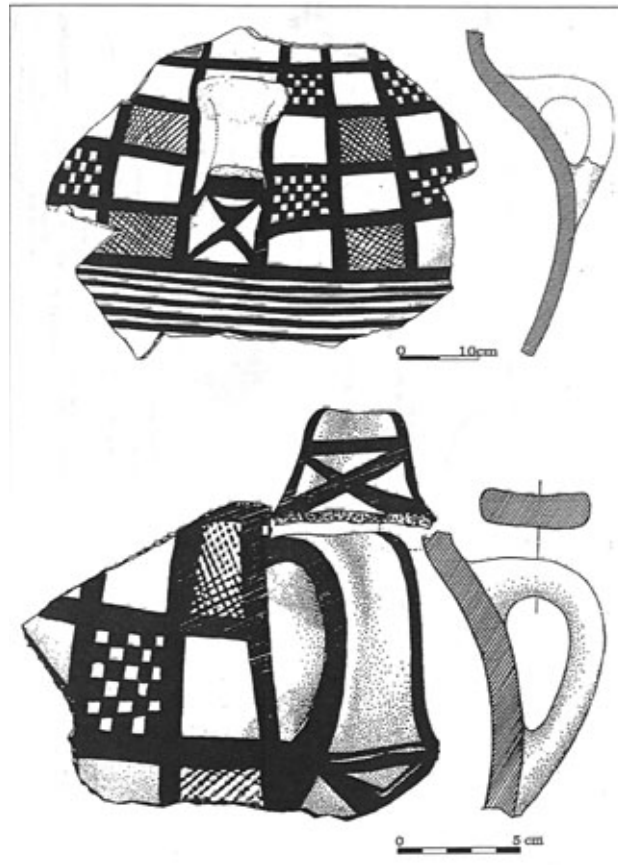

Pl. 394. Carte de répartition de la céramique phrygienne³⁸⁸.

³⁸⁸ PRAYON, WIRKKE, 1994, Karte 14.

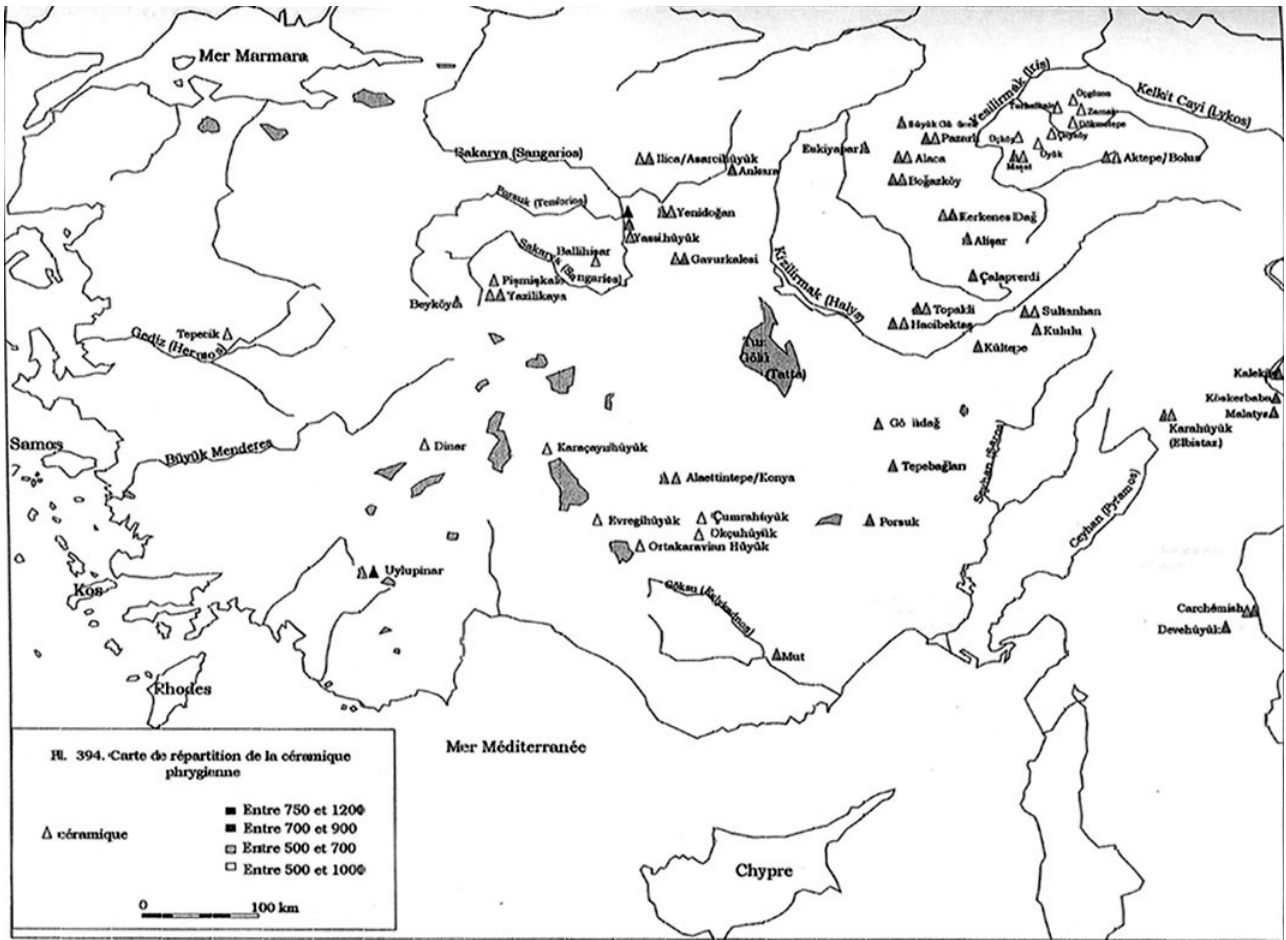

Pl. 395. Carte de répartition de la céramique grecque³⁸⁹.

³⁸⁹ PRAYON, WIRKKE, 1994, Karte 10.

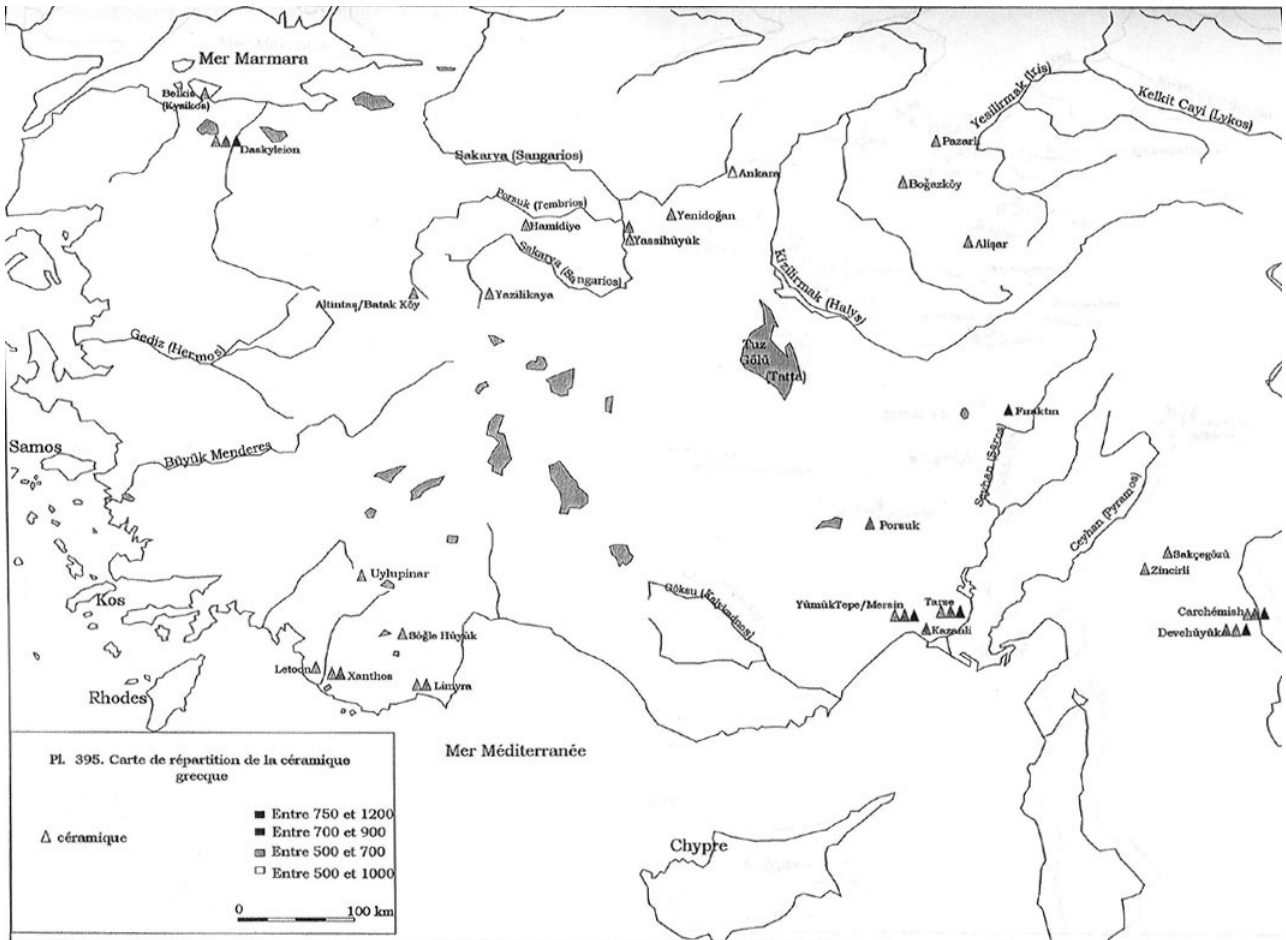

Pl. 396. Carte de répartition des bols.

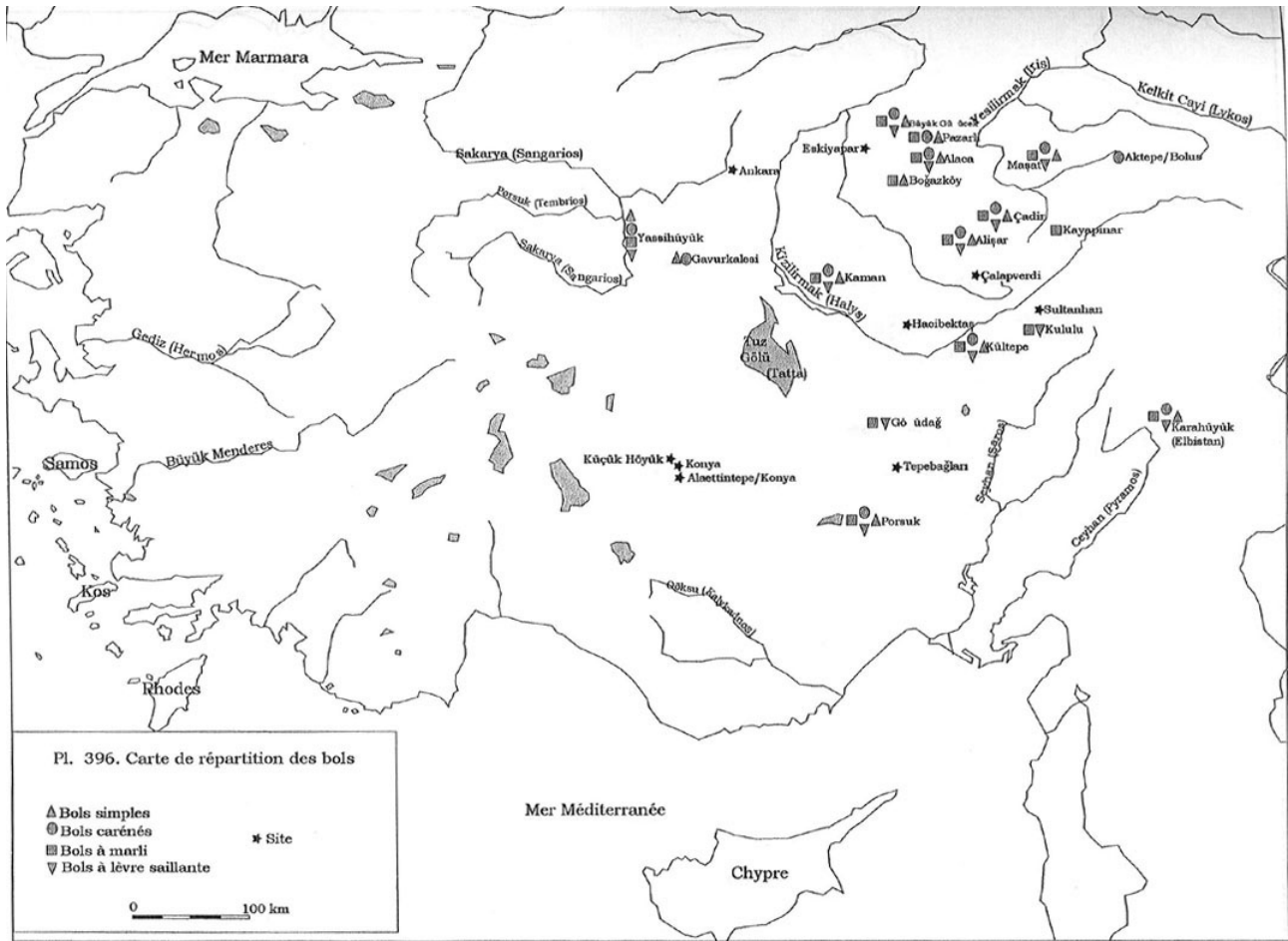

Pl. 397. Carte de répartition des pichets.

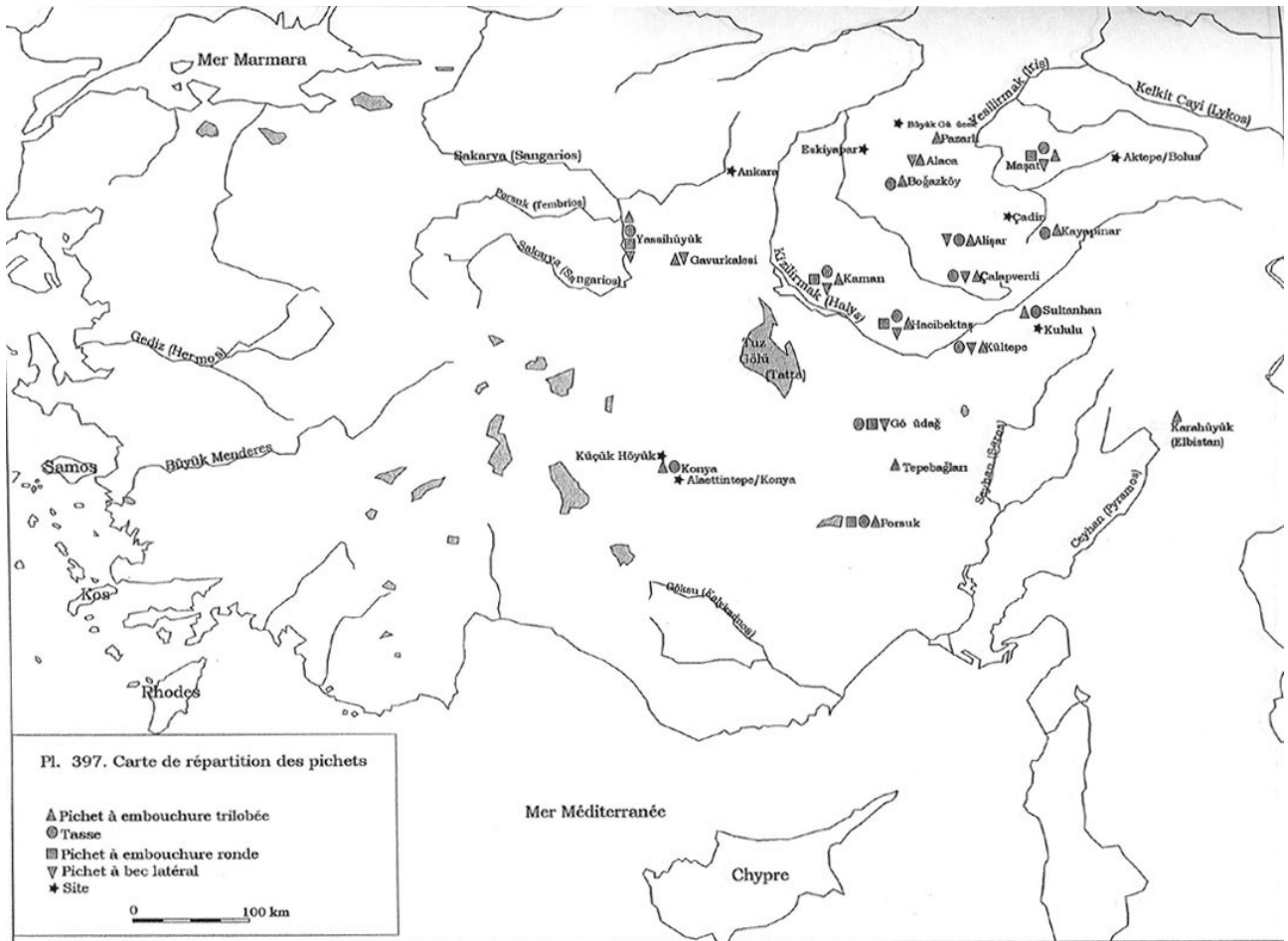

Pl. 398. Carte de répartition des cratères et bords à replat.

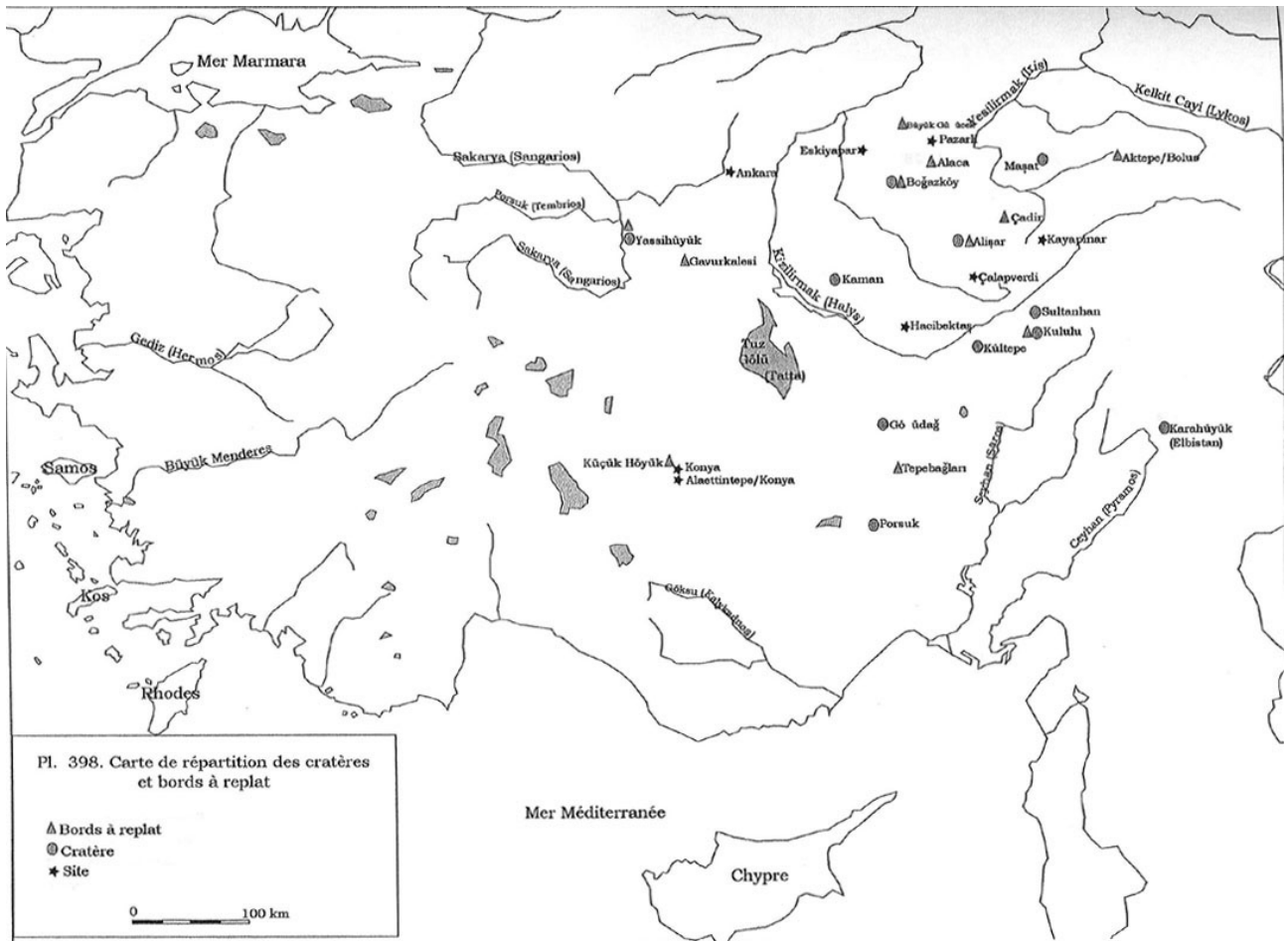

Pl. 399. Carte de répartition des urnes.

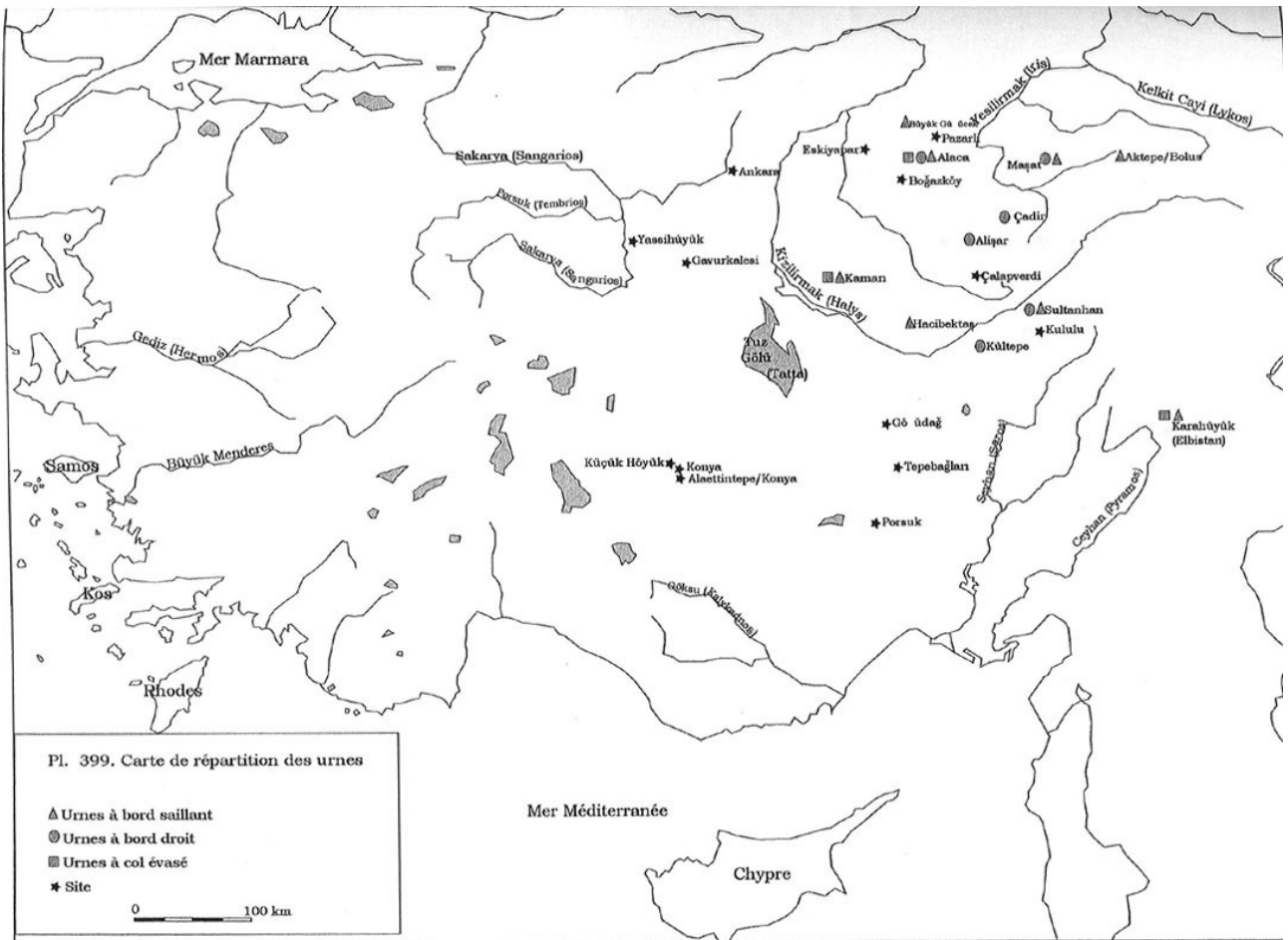

Pl. 400. Carte de répartition des jarres à col cylindrique.

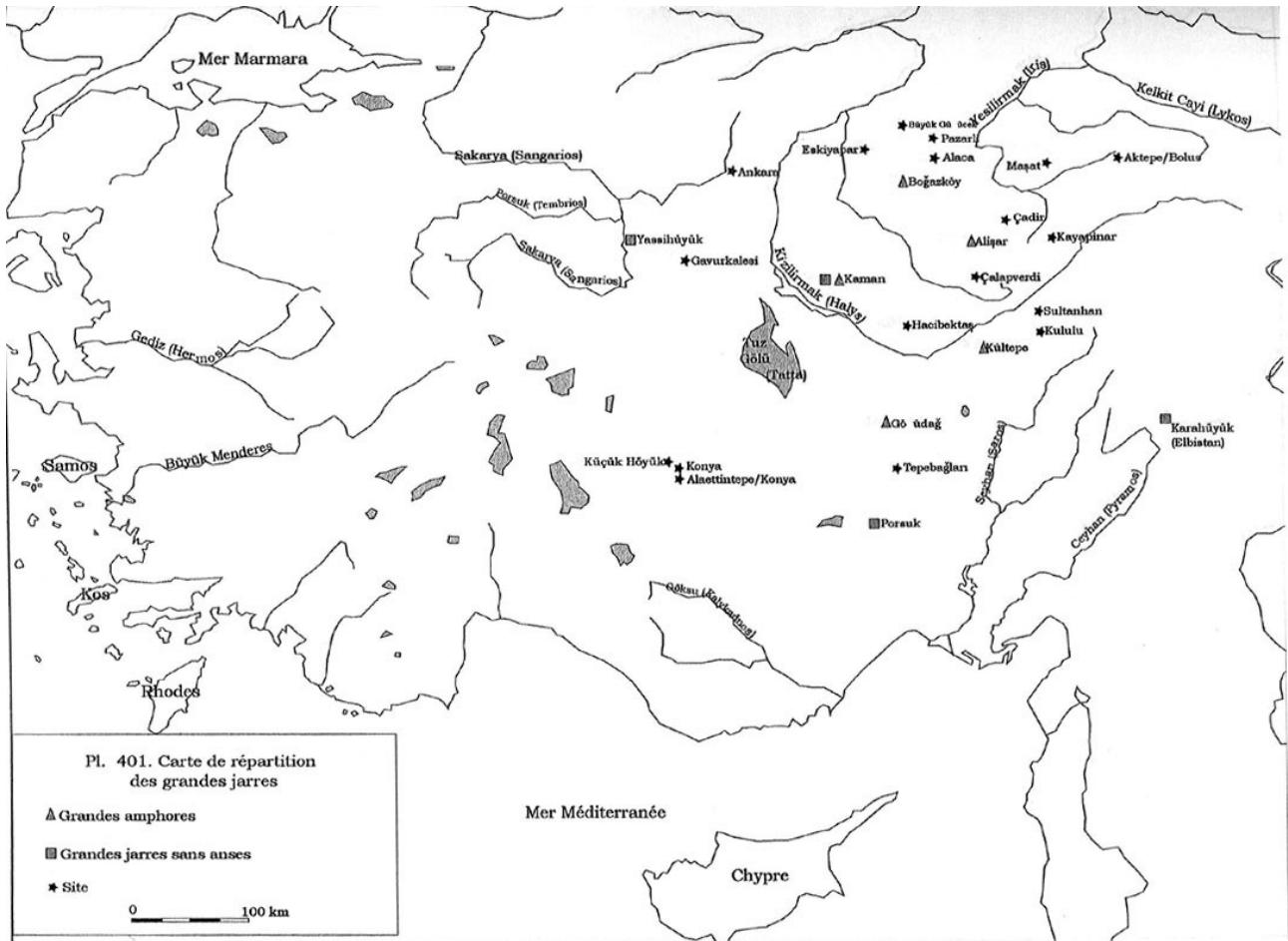

Pl. 401. Carte de répartition des grandes jarres.

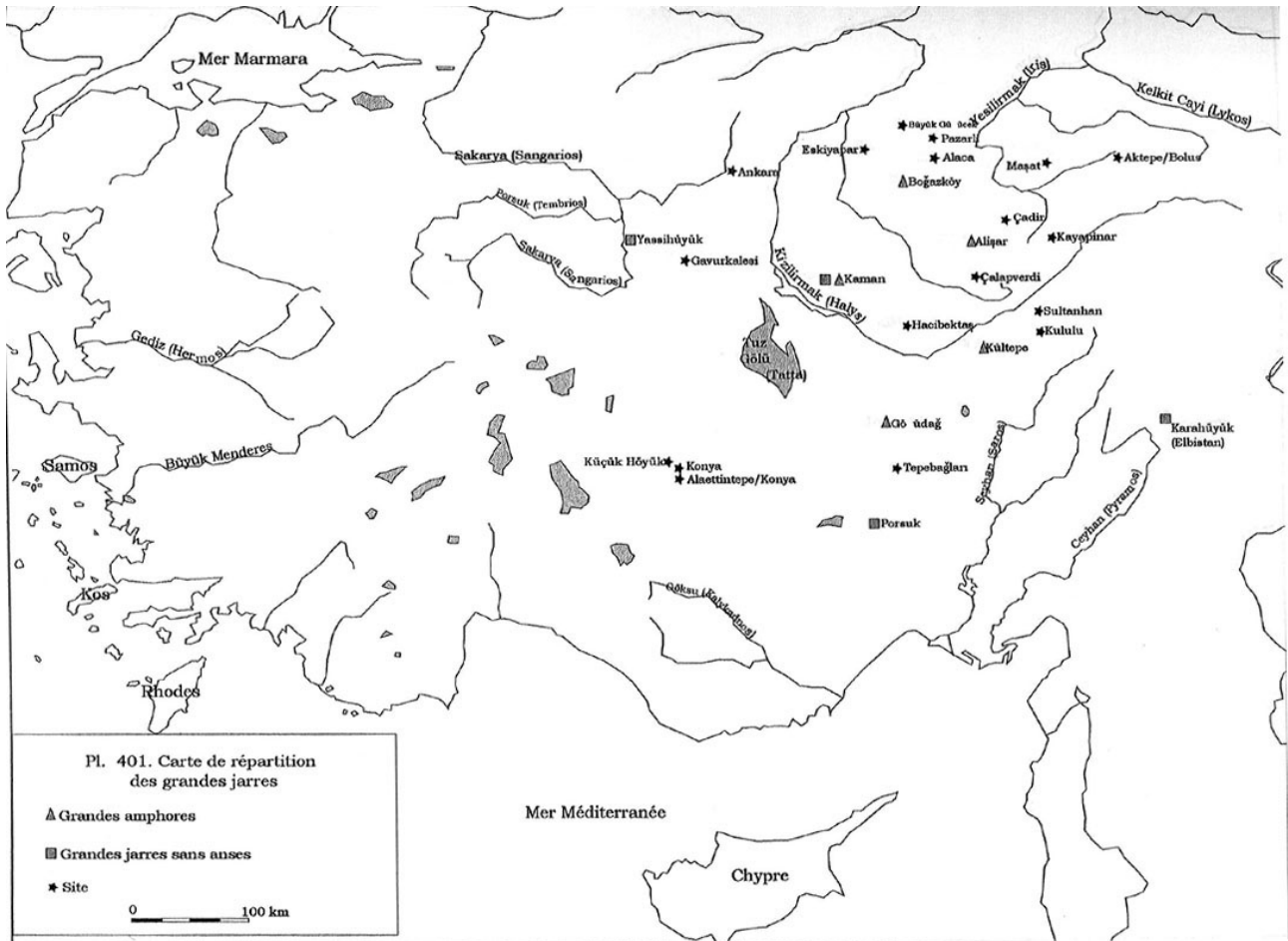

Pl. 402. Carte de répartition des motifs de triangles, papillons, cervidés et cercles concentriques.

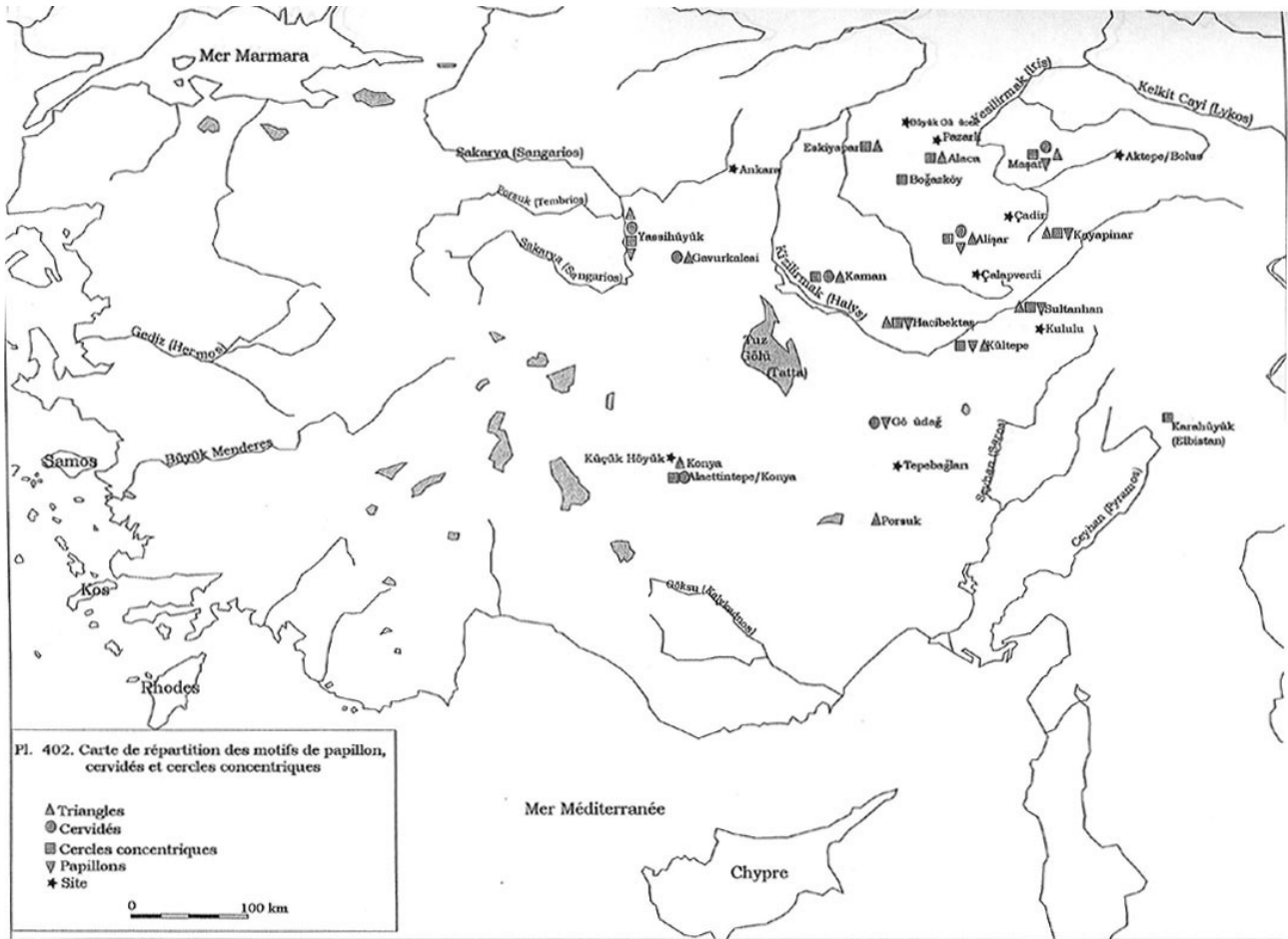

Pl. 403. Carte de répartition des motifs de zigzags, lignes ondulées, festons, et croisillons.

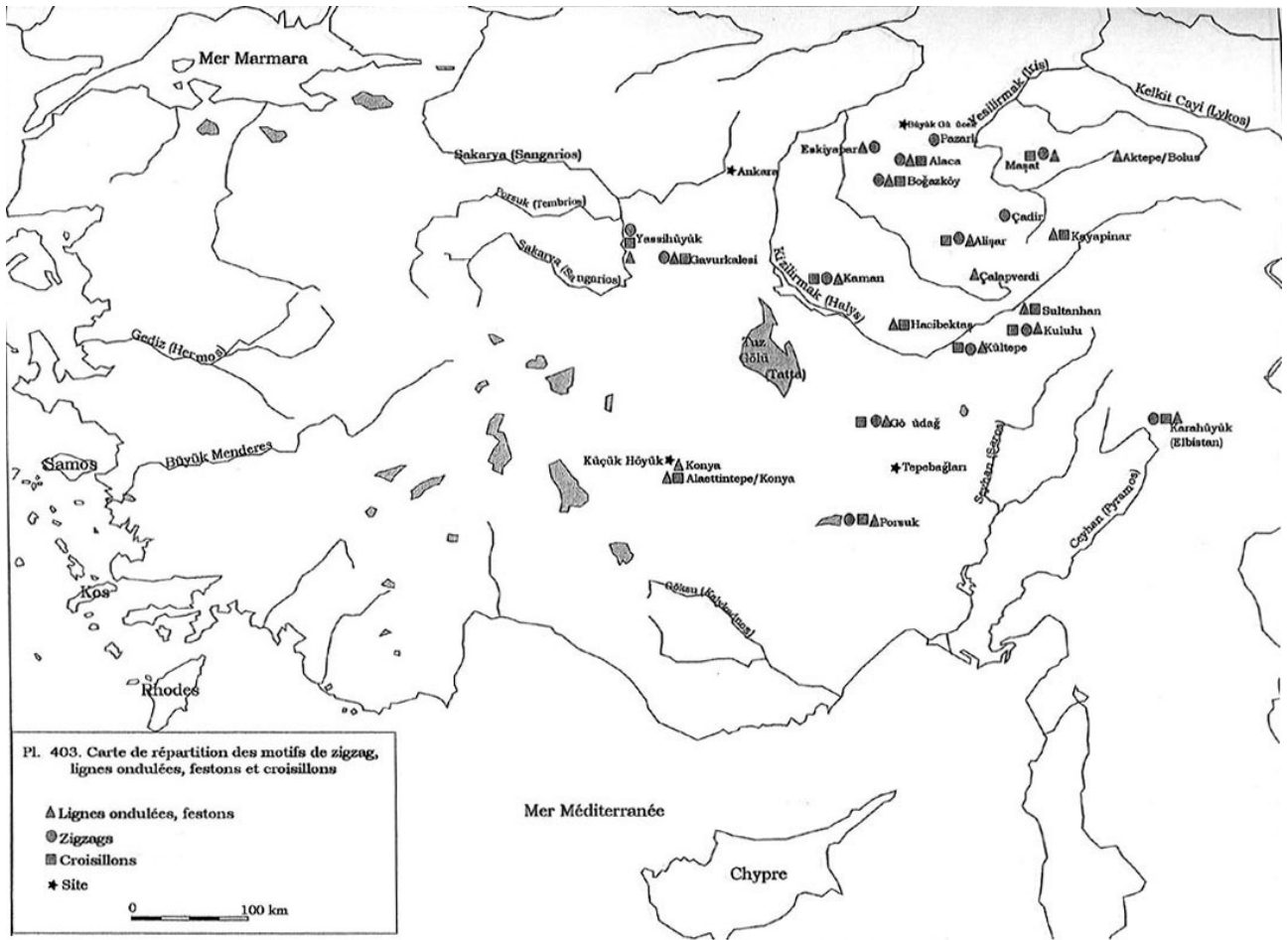

Pl. 404. Carte de répartition des motifs de langues, demi-cercles pendants, arêtes, chevrons et roues.

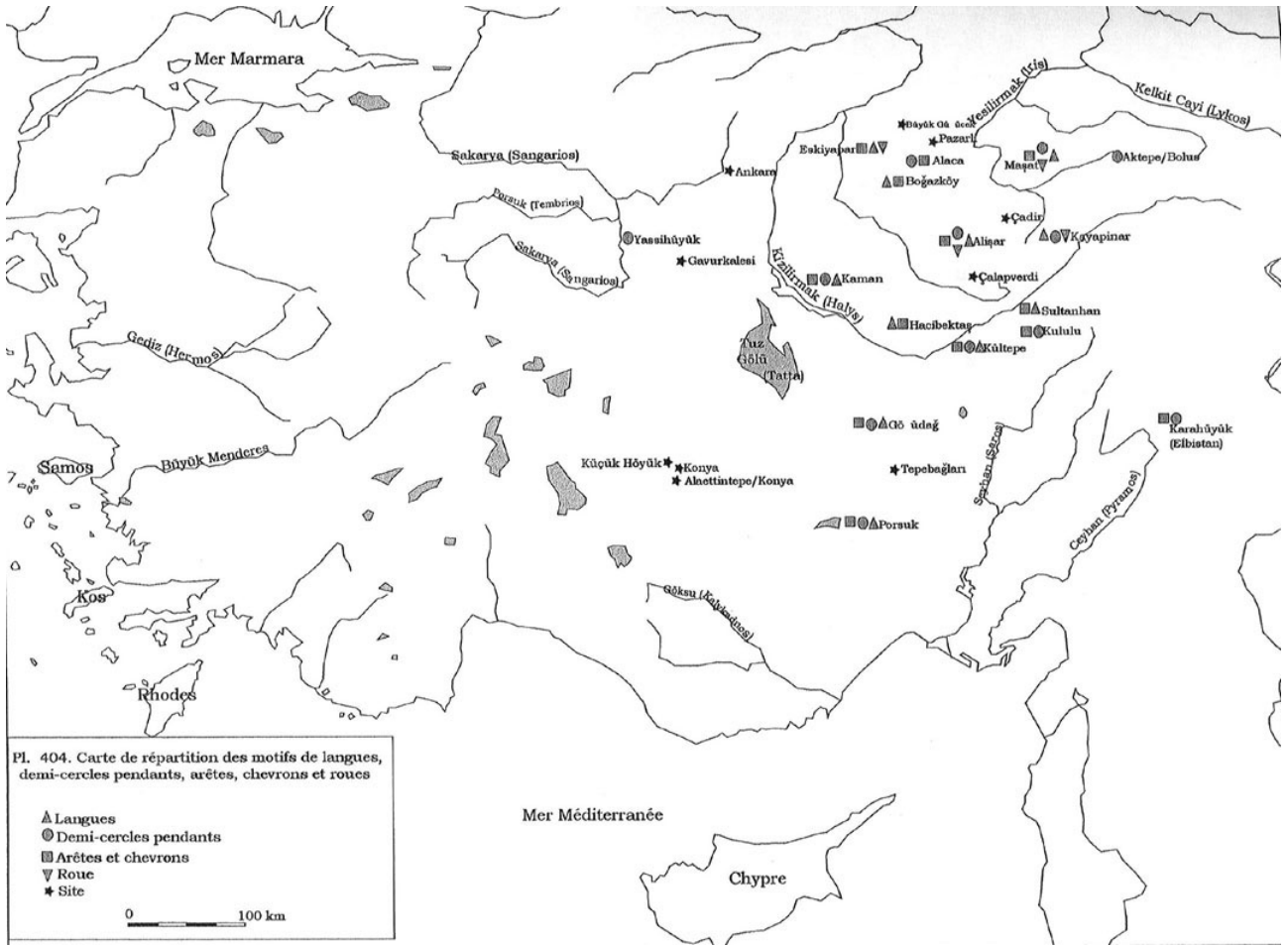

Pl. 405. Carte de répartition des motifs de traits verticaux sur les bords, de losanges, de queue d'aronde, et de damier.

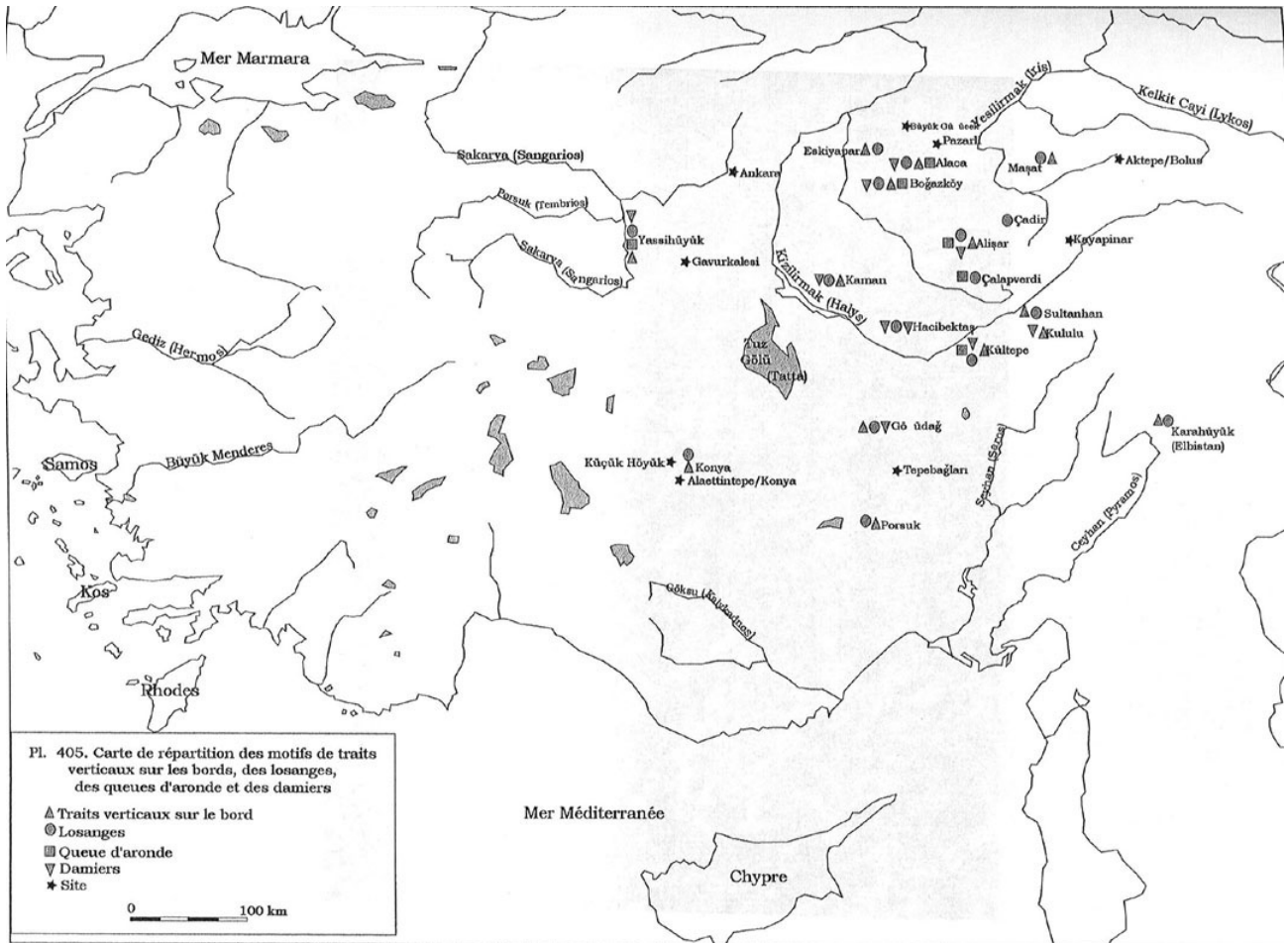

Pl. 406. Tableau des bols.

	Bol Simple 1a	Bol carène 1b	Bol tronconique 1c	Bol à marli 1d	Bol Lévé. Saill. 1e
Kaman					
Masat					
Gordon					
Kayapınar					
Karahöyük					
Kültepe					
Kululu					
Hacıbektaş					
Küçük Hüyük					
Konya					
Tepebağları					
Göllüdag					
Eskiyapar					
çalapverdi					
Bogazkoy					
Büyük Güllücek					
Alisar					
Porsuk					
Pazarlı					
çadır					
Aktepe					
Sultanhan					
Alaca					
Gavurkalesi					

Pl. 407. Tableau des tasses et pichets.

	Tasse à col bas 2a	Tasse à col haut 2b	Tasse à col trilobe 2c	Pichet Emb.Trilob. 2d	Pichet à bec lat. 2e	Pichet Emb. Ron. 2f
Kaman						
Masat						
Gordion						
Kayapınar						
Karahöyük						
Kültepe						
Kululu						
Hacıbektaş						
Küçük Hüyük						
Konya						
Tepebağları						
Göllüdag						
Eskişehir						
çalapverdi						
Bogazköy						
Büyük Güllücek						
Alisar						
Porsuk						
Pazarlı						
çadır						
Aktepe						
Sultanhan						
Alaca						

Pl. 408. Tableau des vases fermés.

	Cratère 3a	Dinos 4a	Vase panse sphérique 4b	Bord replat 7a
Kaman				
Masat				
Gordion				
Kayapınar				
Karahöyük				
Kültepe				
Kululu				
Hacıbektaş				
Küçük Hüyük				
Konya				
Tepebağları				
Göllüdag				
Eskişehir				
çalapverdi				
Bogazköy				
Büyük Güllücek				
Alisar				
Porsuk				
Pazarlı				
çadır				
Aktepe				
Sultanhan				
Alaca				
Gavurkalesi				





Pl. 409. Tableau des urnes.

	Urne à bord droit 5a	Urne à bord saill. 5b	Urne à col évasé 5c
Kaman			
Masat			
Gordion			
Kayapinar			
Karahöyük			
Kültepe			
Kulu			
Hacibektas			
Küçük Hüyük			
Konya			
Tepebagları			
Göllüdag			
Eskiyapar			
çalapverdi			
Bogazköy			
Büyük Güllücek			
Alisar			
Porsuk			
Pazarlı			
çadır			
Aktepe			
Sultanhan			
Alaca			
Gavurkalesi			



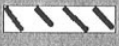



Pl. 410. Tableau des jarres à col cylindrique et des grands vases fermés.

	Jarre trapue 6a	Jarre à anses 6b	Jarre sans anse 6c	Jarre à cordon 6d	Amphore 8a	Grandes jarres sans anses 8b
Kaman						
Masat						
Gordion						
Kayapinar						
Karahöyük						
Kültepe						
Kulu						
Hacibektas						
Küçük Hüyük						
Konya						
Tepebagları						
Göllüdag						
Eskiyapar						
çalapverdi						
Bogazköy						
Büyük Güllücek						
Alisar						
Porsuk						
Pazarlı						
çadır						
Aktepe						
Sultanhan						
Alaca						
Gavurkalesi						







Pl. 411. Tableau des motifs linéaires.

						
	Traits transversaux 1a	Traits obliques 1b	Traits alternés 1c	Ligne oblique 3a	Ligne horizontale 3b	Ligne verticale 3c
Kaman						
Masat						
Gordion						
Kayapinar						
Karahöyük						
Kultepe						
Kulu						
Hacıbektaş						
Küçük Hüyük						
Konya						
Tepebağları						
Göllüdag						
Eskiyapar						
çalapverdi						
Bogazköy						
Büyük Gülücek						
Alisar						
Porsuk						
Pazarlı						
çadır						
Aktepe						
Sultanhan						
Alaca						
Gavurkalesi						







Pl. 412. Tableau des triangles 1.

							
	Pendants 2a	à pointillé 2b	Seul 2c	à croisillons 2d	alternés 2e	pendants opposés 2f	hachures 2g
Kaman							
Masat							
Gordion							
Kayapinar							
Karahöyük							
Kultepe							
Kulu							
Hacıbektaş							
Küçük Hüyük							
Konya							
Tepebağları							
Göllüdag							
Eskiyapar							
çalapverdi							
Bogazköy							
Büyük Gülücek							
Alisar							
Porsuk							
Pazarlı							
çadır							
Aktepe							
Sultanhan							
Alaca							
Gavurkalesi							









Pl. 413. Tableau des triangles 2.

	 au double trait 2h	 a pointe en losange 2i	 Triangle noir 2j	 a chevron 2.k	 Queue d'aronde 2l	 Lingot ou papillon 9d
Kaman						
Masar						
Gordion						
Kayapinar						
Karahöyük						
Kultepe						
Kulu						
Hacibektaş						
Küçük Hüyük						
Konya						
Tepebağları						
Göllüdağ						
Eskiyapar						
çalıverdi						
Bogazköy						
Büyük Gullücek						
Alisar						
Forsuk						
Pazarlı						
çadır						
Aktepe						
Sultanhan						
Alaca						
Gavurkalesi						







Pl. 414. Tableau des motifs linéaires complexes et des points.

	 Chevrons verticaux 4a	 Chevrons horizontaux 4b	 Arc 4c	 Croisillons 4d	 Croix 4e	 Ligne de points 7a	 Bande de points 7b
Kaman							
Masar							
Gordion							
Kayapinar							
Karahöyük							
Kultepe							
Kulu							
Hacibektaş							
Küçük Hüyük							
Konya							
Tepebağları							
Göllüdağ							
Eskiyapar							
çalıverdi							
Bogazköy							
Büyük Gullücek							
Alisar							
Forsuk							
Pazarlı							
çadır							
Aktepe							
Sultanhan							
Alaca							
Gavurkalesi							
Alaçın-tepe							







Pl. 415. Tableau des losanges.

								
	Alternés 5a	Dans losange 5b	à croisillons 5c	à damier 5d	à pointillés 5e	Triple trait 5f	Hachure 5g	Noir 5h
Kaman								
Masat								
Gordion								
Kayapinar								
Karahöyük								
Kultepe								
Kululu								
Hacıbektaş								
Küçük Hüyük								
Konya								
Tepebağları								
Göllüdag								
Eskiöpar								
çalapverdi								
Bogazköy								
Büyük Güllücek								
Alisar								
Porsuk								
Pazarlı								
çadır								
Aktepe								
Sultanhan								
Alaca								
Gavurkalesi								





Pl. 416. Tableau des zigzags et des motifs géométriques complexes.

							
	Zigzag 6a	W 6b	Zigzags multiples 6c	Damiers 6d	Echelle 6e	Langues 6f	Méandre 6g
Kaman							
Masat							
Gordion							
Kayapinar							
Karahöyük							
Kultepe							
Kululu							
Hacıbektaş							
Küçük Hüyük							
Konya							
Tepebağları							
Göllüdag							
Eskiöpar							
çalapverdi							
Bogazköy							
Büyük Güllücek							
Alisar							
Porsuk							
Pazarlı							
çadır							
Aktepe							
Sultanhan							
Alaca							
Gavurkalesi							

Pl. 417. Tableau des cercles concentriques et des motifs figuratifs.

	 Double 8a	 avec point 8b	 Multiple 8c	 Demi-cercle 8d	 Olive 8e	 Roue 8f	Cervides 11a	Zoom 11b	Arbre Styl. 11c
Kaman									
Masat									
Gordion									
Kayapinar									
Karahöyük									
Kültepe									
Kululu									
Hacıbektaş									
Küçük Hüyük									
Konya									
Tepebağları									
Göllüdag									
Eskiyapar									
çalapverdi									
Bogazköy									
Büyük Güllücek									
Alisar									
Porsuk									
Pazarlı									
çadır									
Aktepe									
Sultanhan									
Topaklı									
Alaca									
Gavurkalesi									
Alaçtintepe									

Pl. 418. Tableau des lignes ondulées.

	 Ligne ondulée 10a	 Verticale pendante 10b	 Horizontale pendante 10c	 Feston 10d
Kaman				
Masat				
Gordion				
Kayapinar				
Karahöyük				
Kültepe				
Kululu				
Hacıbektaş				
Küçük Hüyük				
Konya				
Tepebağları				
Göllüdag				
Eskiyapar				
çalapverdi				
Bogazköy				
Büyük Güllücek				
Alisar				
Porsuk				
Pazarlı				
çadır				
Aktepe				
Sultanhan				
Alaca				
Gavurkalesi				
Alaçtintepe				

Pl. 419. Lampes, pesons et fusaïoles, Alışar³⁹⁰.

³⁹⁰SCHMIDT, KROGMAN, 1933, fig. 66-69, 337-338.



Pl. 420. Fusaïoles, niveau 2-3, höyük A, Alişar³⁹¹.

³⁹¹SCHMIDT, KROGMAN, 1933, fig. 70-71.



Pl. 421. Fusaioles, Alişar³⁹².

³⁹²SCHMIDT, KROGMAN, 1933, fig. 73-74.

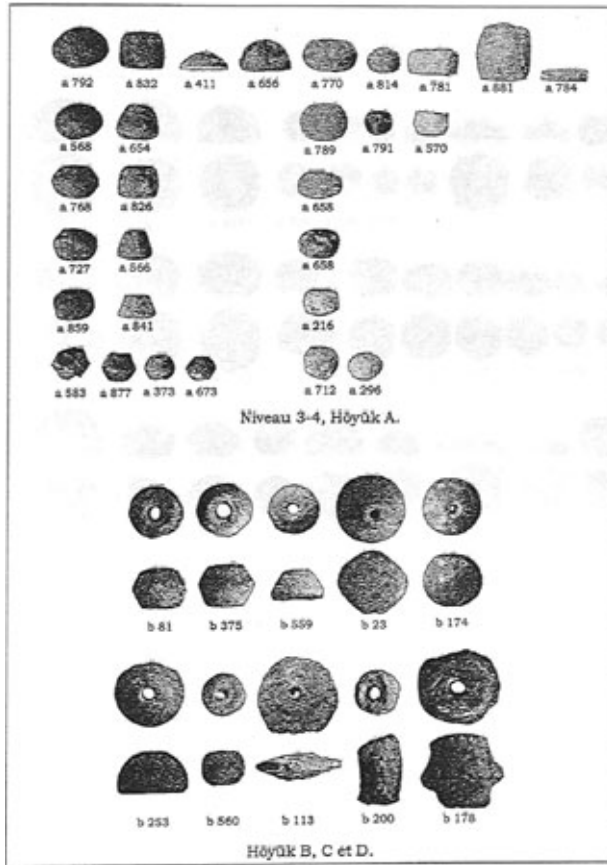

Pl. 422. Fusaïoles, Alişar³⁹³.

³⁹³SCHMIDT, KROGMAN, 1933, fig. 399-340.

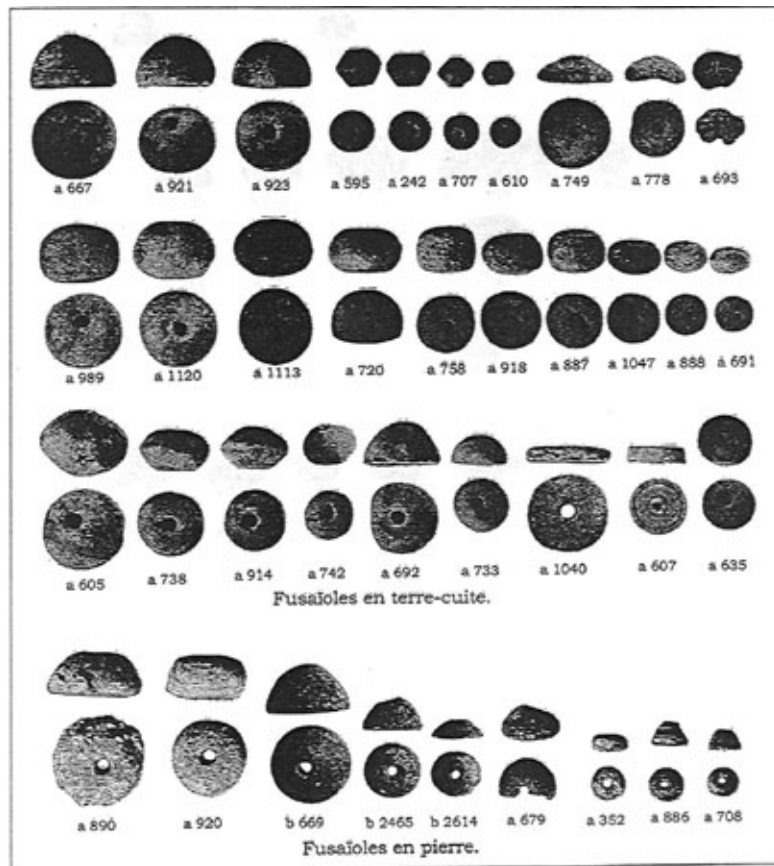

Pl. 423. Fusaiöles, niveau 2-4, höyük A, Alişar³⁹⁴.

³⁹⁴SCHMIDT, KROGMAN, 1933, fig. 75-78.

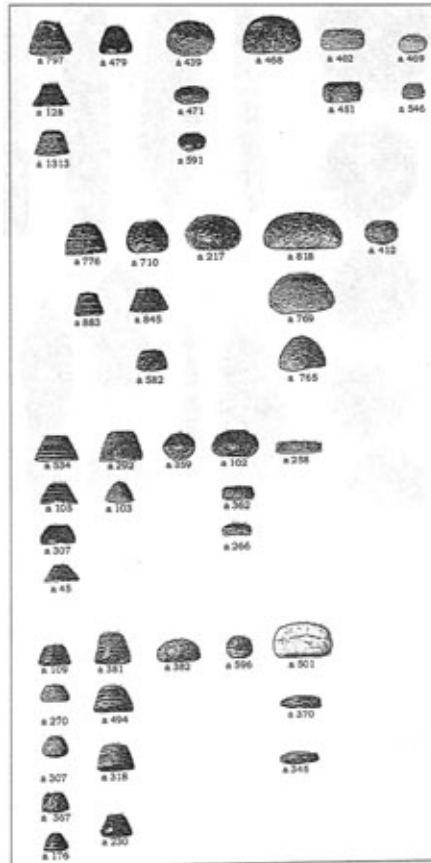

Pl. 424. Objets en os et fusaïoles, Karahöyük³⁹⁵.

³⁹⁵ÖZGÜÇ, 1949, Lev. XXXIX.

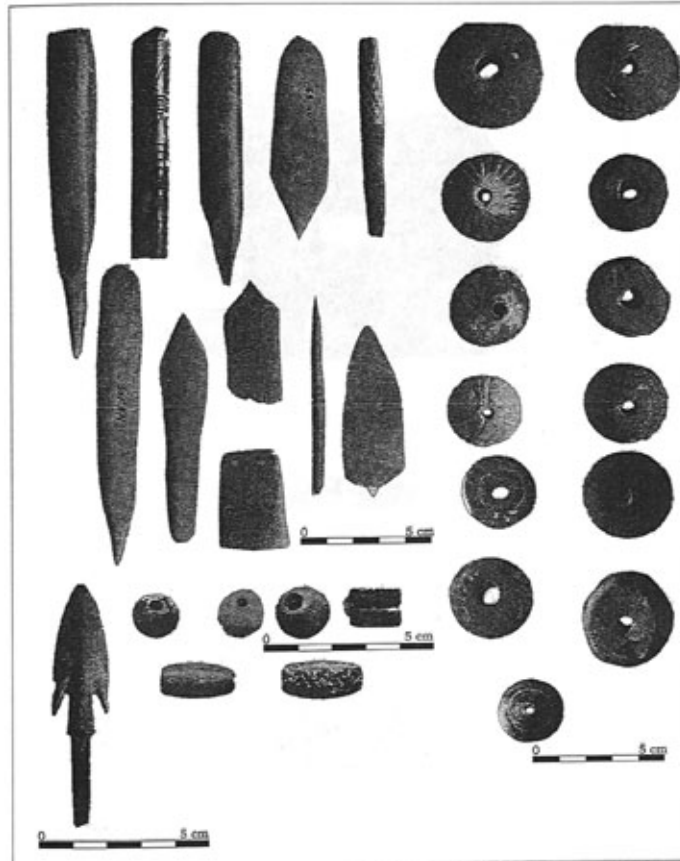

Pl. 425. Sceau en ivoire, Kaman Kalehöyük³⁹⁶.

³⁹⁶OMURA, 1995, fig. 1.



Pl. 426. Sculpture zoomorphe en terre-cuite, Kaman Kalehöyük³⁹⁷.

³⁹⁷OMURA, 1995 fig. 17. 5.

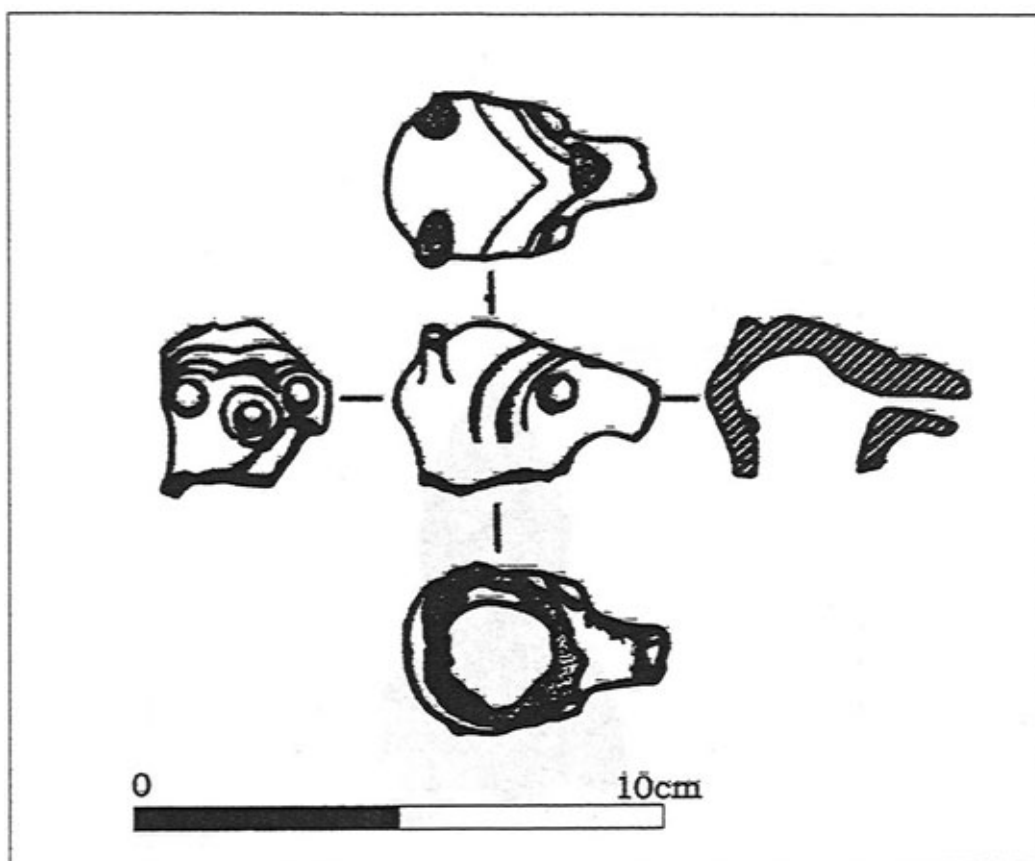

Pl. 427. Pied en terre-cuite, pendentif en os, et amulettes en fritte, Alişar³⁹⁸.



Pl. 428. Statuette de divinité « levantine », sceau avec une divinité entre des capridés affrontés, Maşat³⁹⁹.

³⁹⁸SCHMIDT, KROGMAN, 1933, fig. 82-83.

³⁹⁹ÖZGÜÇ, 1978, pl. 78.



Pl. 429. Sceaux post-hittites, Alisar⁴⁰⁰.

⁴⁰⁰Von der OSTEN, 1930-31, fig. 50.

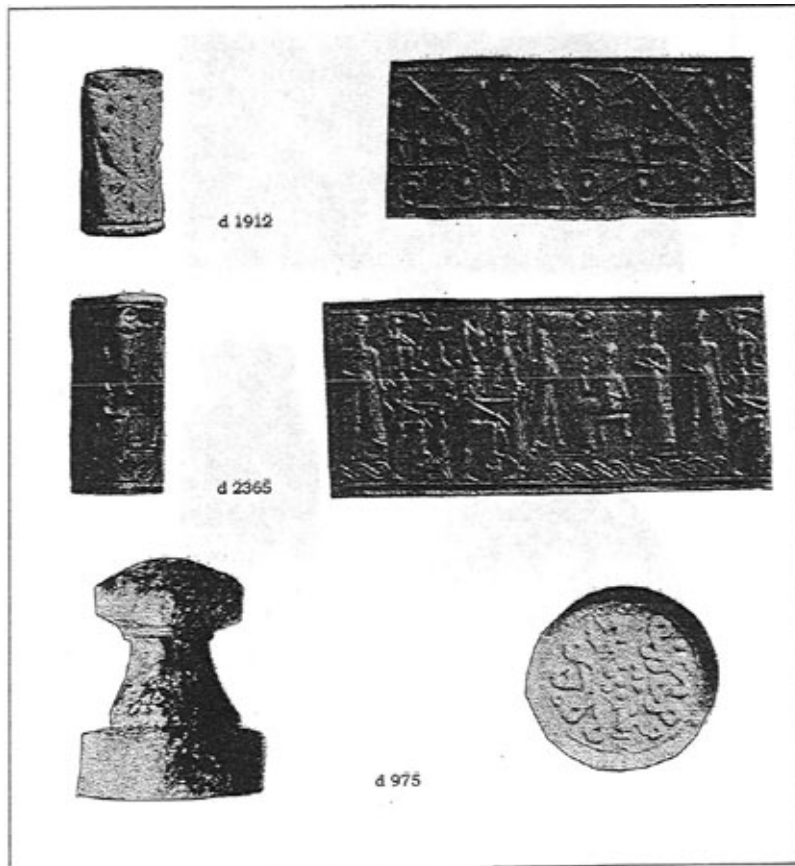

Pl. 430. Empreinte moderne de sceau et objets post-hittites, Alişar⁴⁰¹.

⁴⁰¹von der OSTEN, 1930-31, fig. 31.

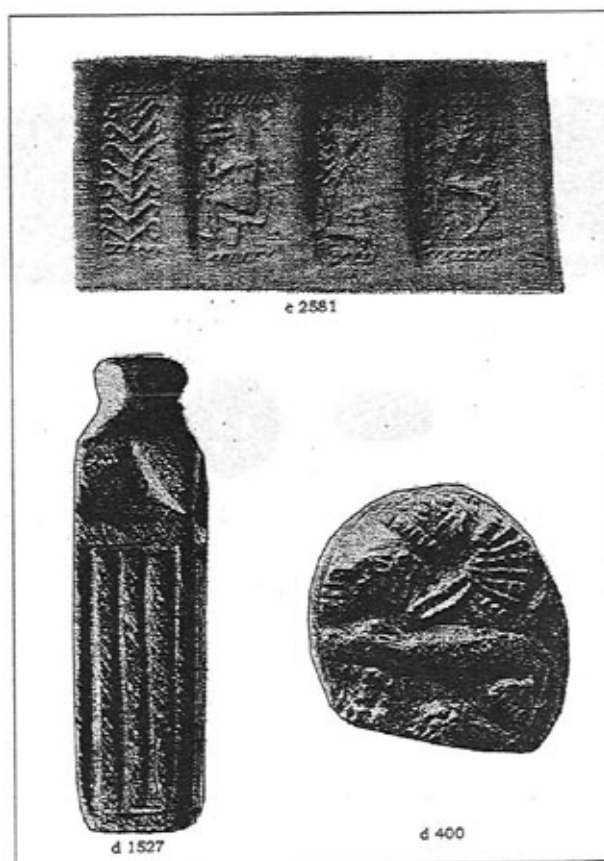

Pl. 431. Bullae avec inscriptions hiéroglyphiques, niveau IV, Alişar⁴⁰².

⁴⁰²SCHMIDT, KROGMAN, 1933, fig. 342-344.



Pl. 432. Scarabées, matériel importé, Alişar⁴⁰³.

⁴⁰³SCHMIDT, KROGMAN, 1933, fig. 345-346.

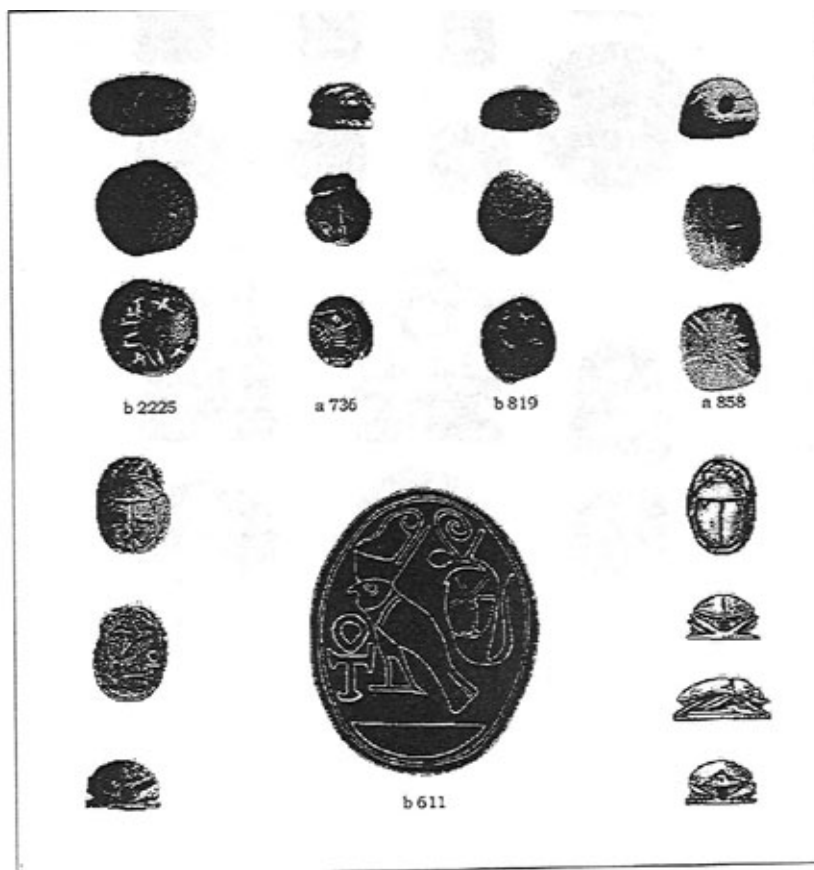

Pl. 433. Sceaux phrygiens d'Emirler, de Boğazköy, de Nemrut Dağ, de Gordion, lydiens d'Ephèse et grecs⁴⁰⁴.

⁴⁰⁴BOEHMER, 1977, Abb. 2-9.



Pl. 434. Matrice de sceau biconvexe, Şarhöyük-Dorylaion⁴⁰⁵.

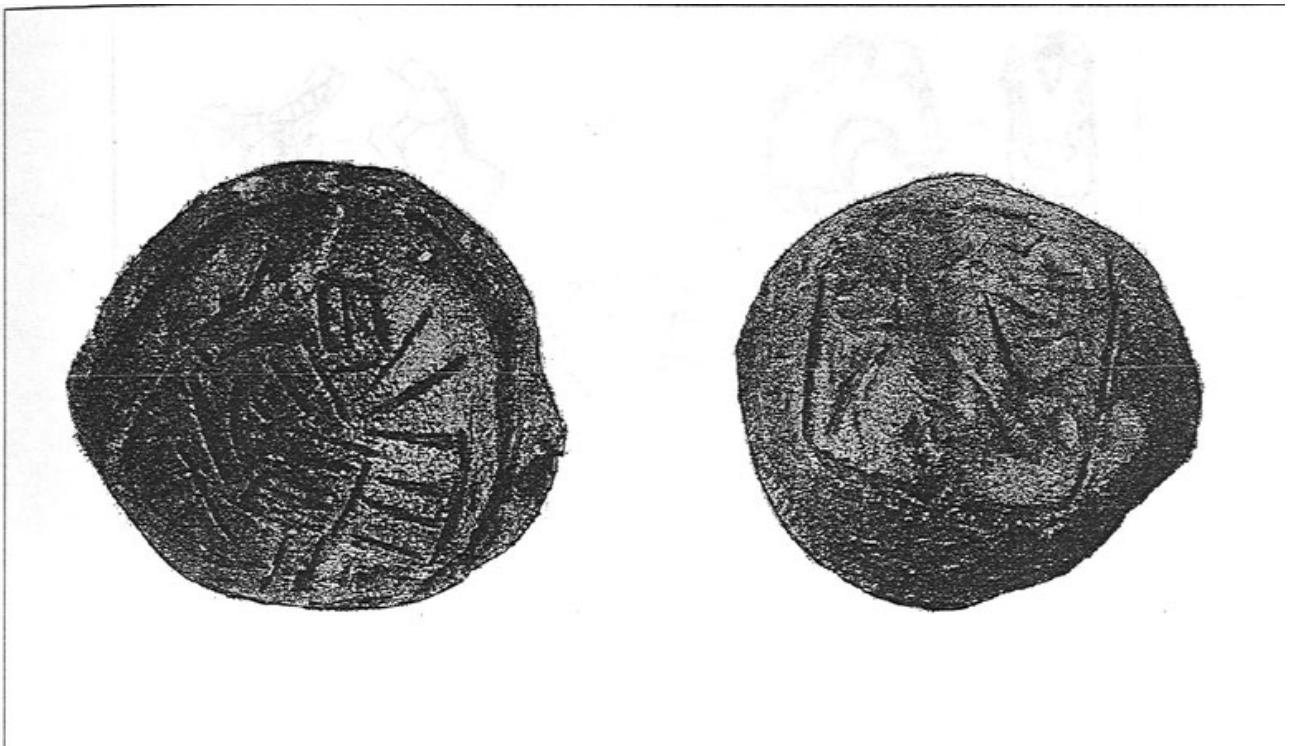

⁴⁰⁵DARGA, 1993, Taf. 35. 4-5.

Pl. 435. Animaux décorant des vases, moules et pied, Kaman⁴⁰⁶.

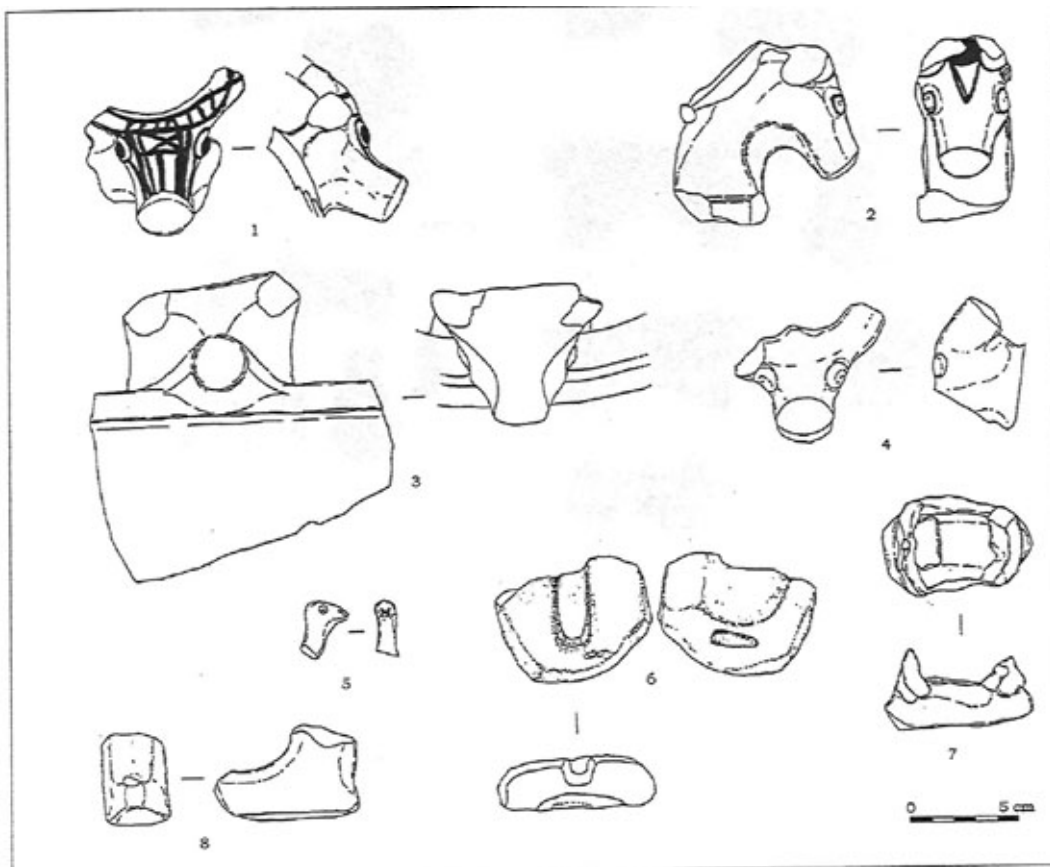

Pl. 436. Petite statuette, Karahöyük, Alişar⁴⁰⁷.

⁴⁰⁶MIKAMI, OMURA, 1991b, fig. 13.

⁴⁰⁷ÖZGÜÇ, 1949, Lev. XLI. SCHMIDT, KROGMAN, 1933, fig. 80.



Petite statuette de terre-cuite, Karahöyük.
ÖZGÖÇ, 1949, Lev. XLI.



Figurine en bronze de chien, Alişar.
SCHMIDT, KROGMAN, 1933, fig. 80.

Pl. 437. Tête d'homme en terre-cuite, Şarhöyük-Dorylaion⁴⁰⁸.

⁴⁰⁸DARGA, 1993, Taf. 35. 1-3.



Pl. 438. Fibules, types XII-2, 9, 13, Gordion⁴⁰⁹.

⁴⁰⁹TEMISOY, 1992, Lev. I-II.

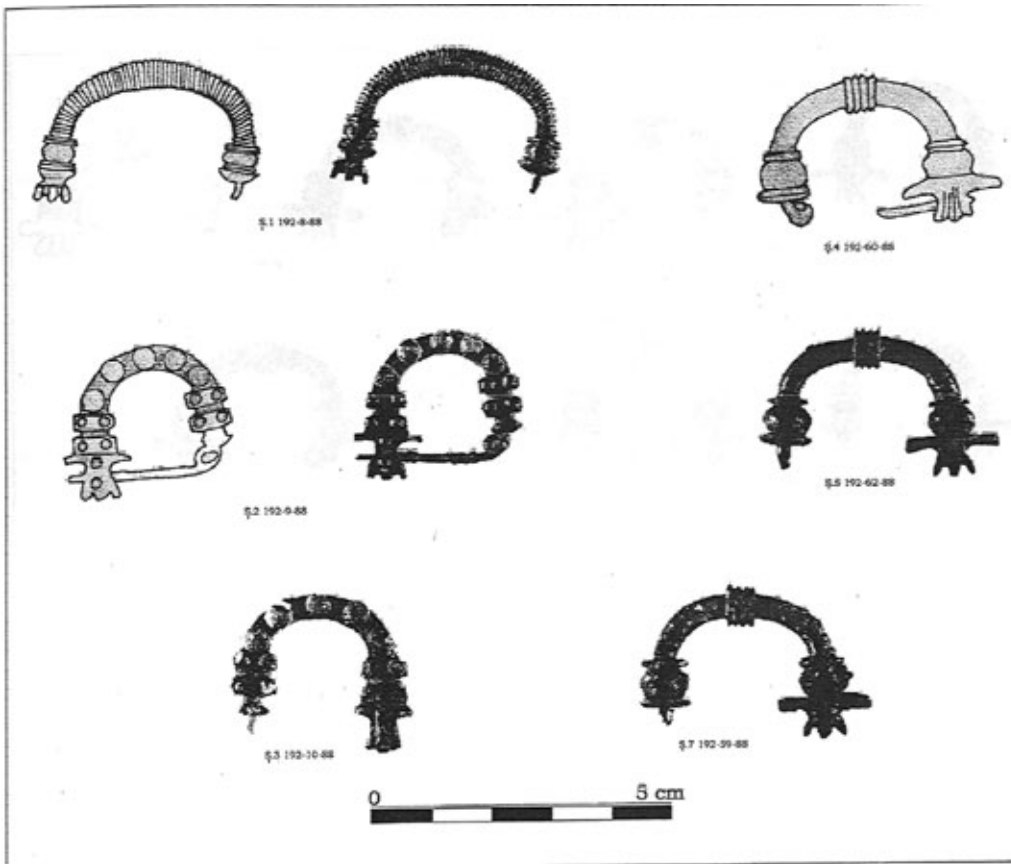

Pl. 439. Fibules, types XII-13, Gordion⁴¹⁰.

⁴¹⁰TEMISOY, 1992, Lev. III-IV.

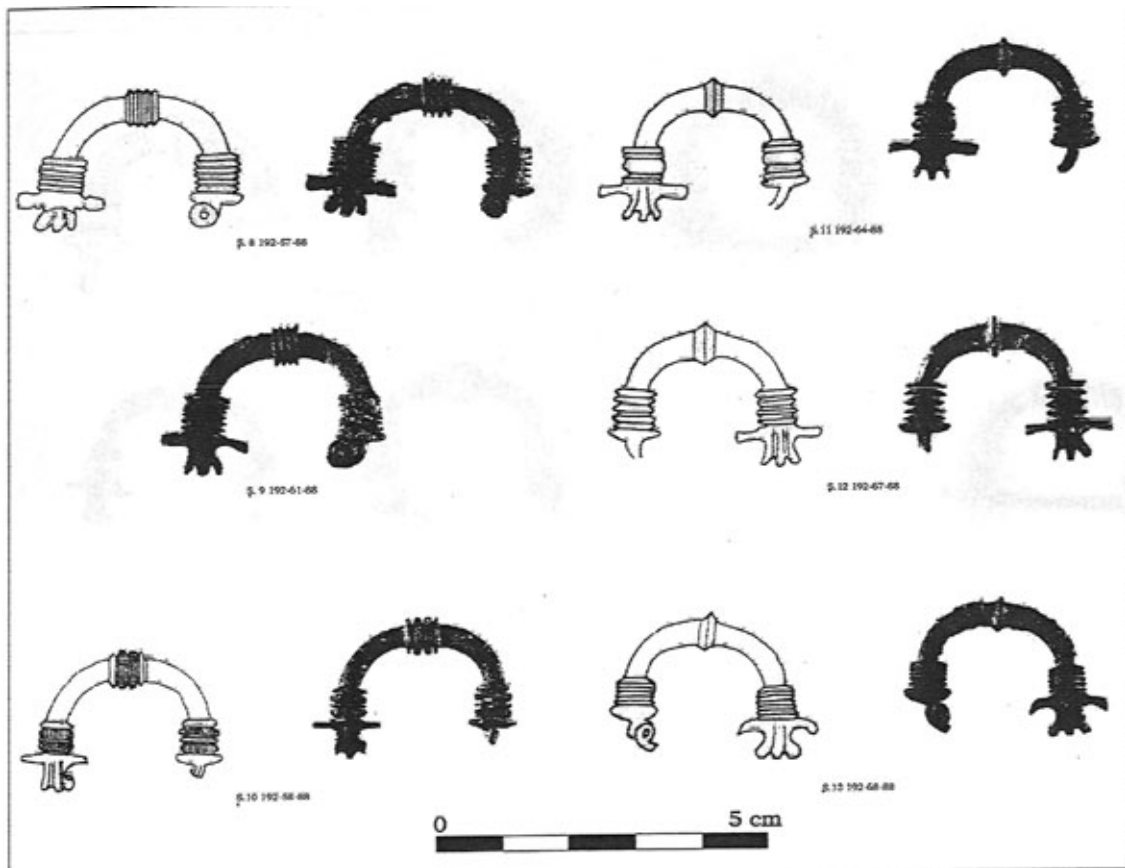

Pl. 440. Fibules, types XII-13, Gordion⁴¹¹.

⁴¹¹TEMISOY, 1992, Lev. V-VI.

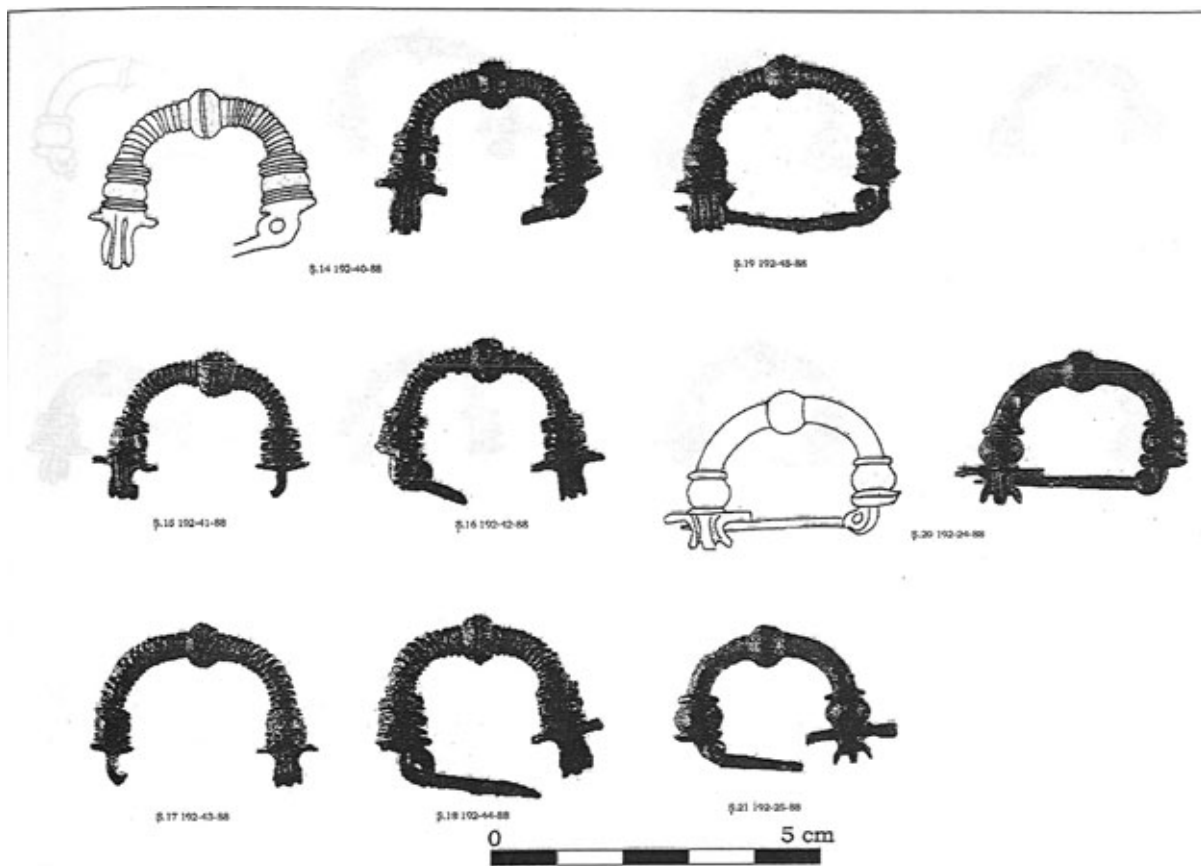

Pl. 441. Fibules, types XII-13, Gordion⁴¹².

⁴¹²TEMISOY, 1992, Lev.VII-VIII.



Pl. 442. Fibules, types XII-13, Gordion⁴¹³.

⁴¹³TEMISOY, 1992, Lev. IX-X.

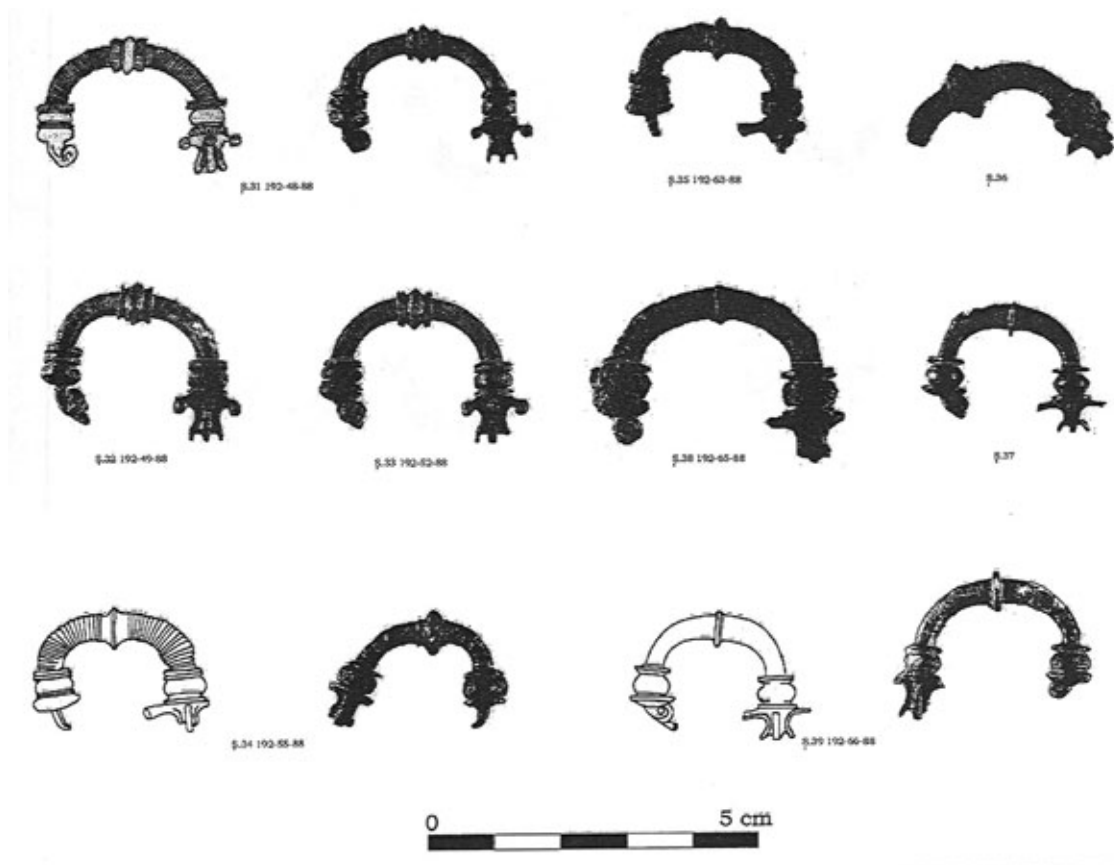

Pl. 443. Fibules, Kaman⁴¹⁴.

⁴¹⁴OMURA, 1996, fig. 1.

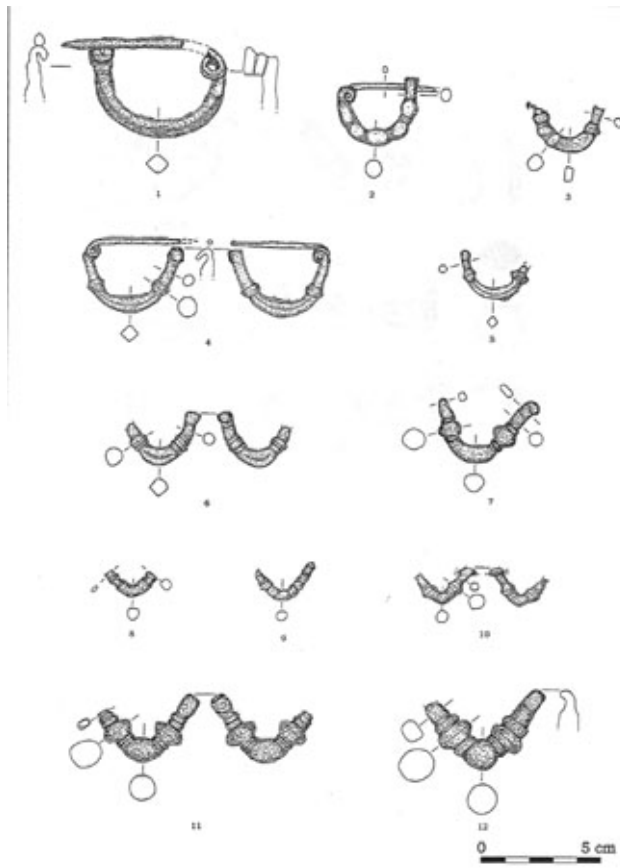

Pl. 444. Pendentif et bagues récents, fibules et moules du niveau 2, Kaman⁴¹⁵.

⁴¹⁵OMURA, 1996, fig. 16. 1-8.

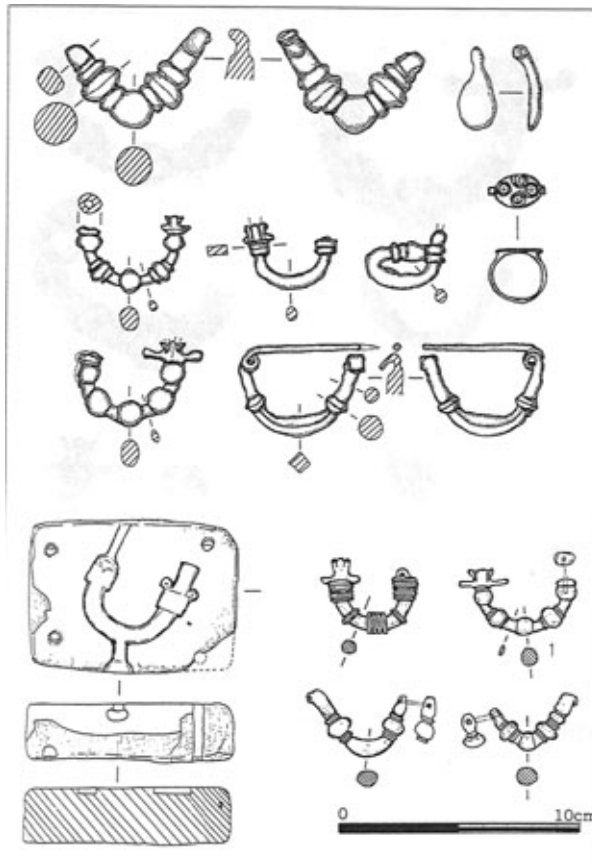

Pl. 445. Fibules, Kaman, Assur⁴¹⁶.

⁴¹⁶MELLINK, 1991, fig. 7-8. BOEHMER, 1983, Abb. 6.



Pl. 446. Fibules de types XII-2, XII-2A, B, XII-7, Boğazköy⁴¹⁷.

⁴¹⁷BOEHMER, 1972, Taf. V.



Pl. 447. Fibules de types XII-7, XII-9, Boğazköy⁴¹⁸.

⁴¹⁸BOEHMER, 1972, Taf. VI.

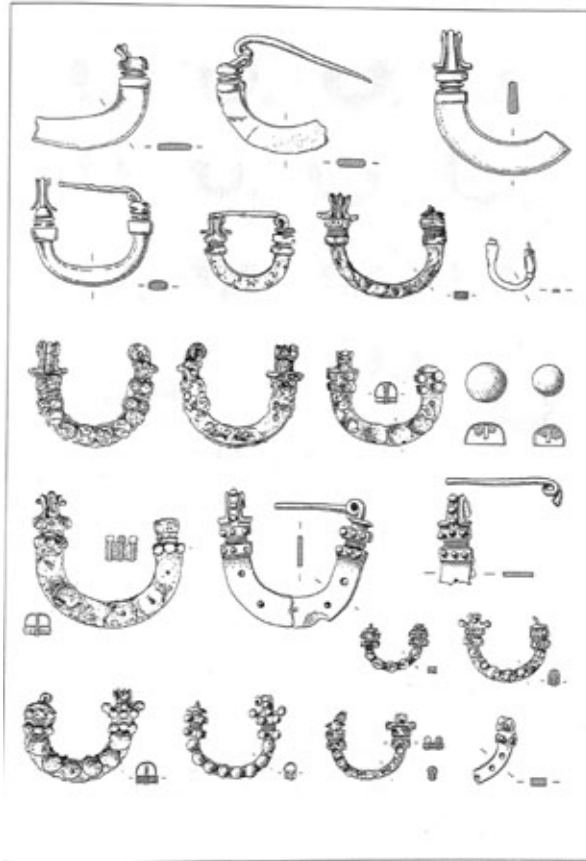

Pl. 448. Fibules de types XII-9A, XII-12, 12A, XII-13, A-B, XII-1, Boğazköy⁴¹⁹.

⁴¹⁹BOEHMER, 1972, Taf. VII.



Pl. 449. Fibules de type XII-14 et proche-oriental (deux dernières lignes), Boğazköy⁴²⁰.

⁴²⁰BOEHMER, 1972, Taf. VIII.

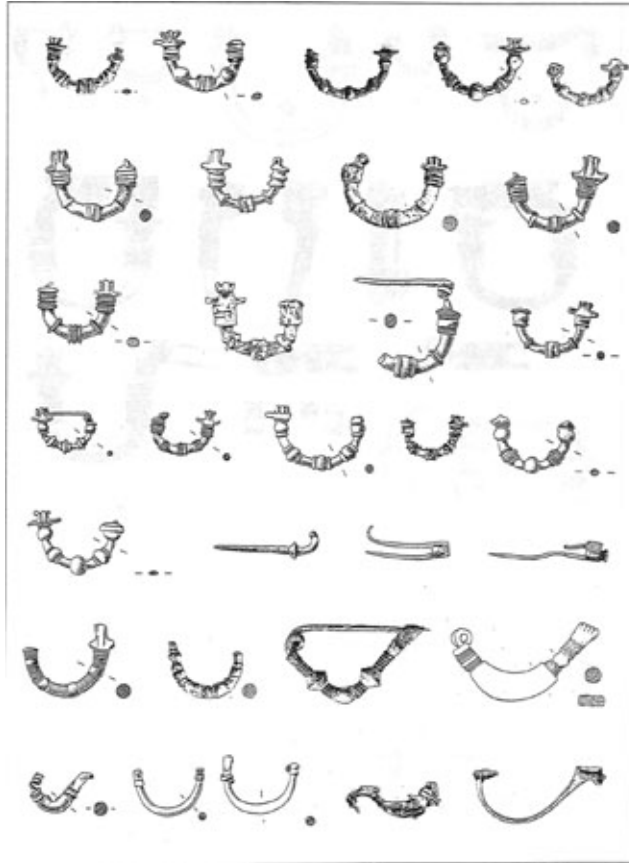

Pl. 450. Fibules de types XII-2A-B, XII-7, XII-9, Boğazköy⁴²¹.

⁴²¹BOEHMER, 1972, Taf. III.

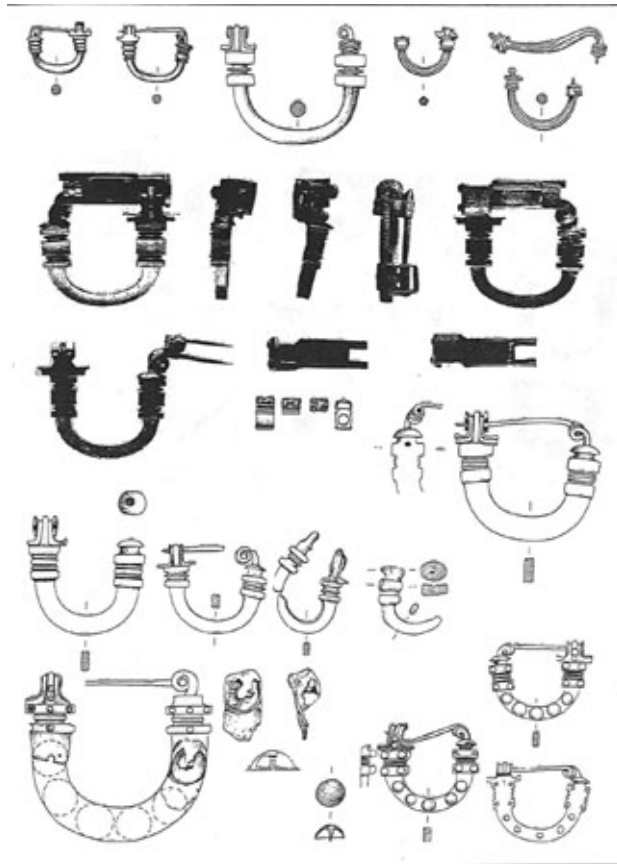

Pl. 451. Fibules de types XII-2, XII-2A, B, XII-7, Boğazköy⁴²².

⁴²²BOEHMER, 1972, Taf. IV.

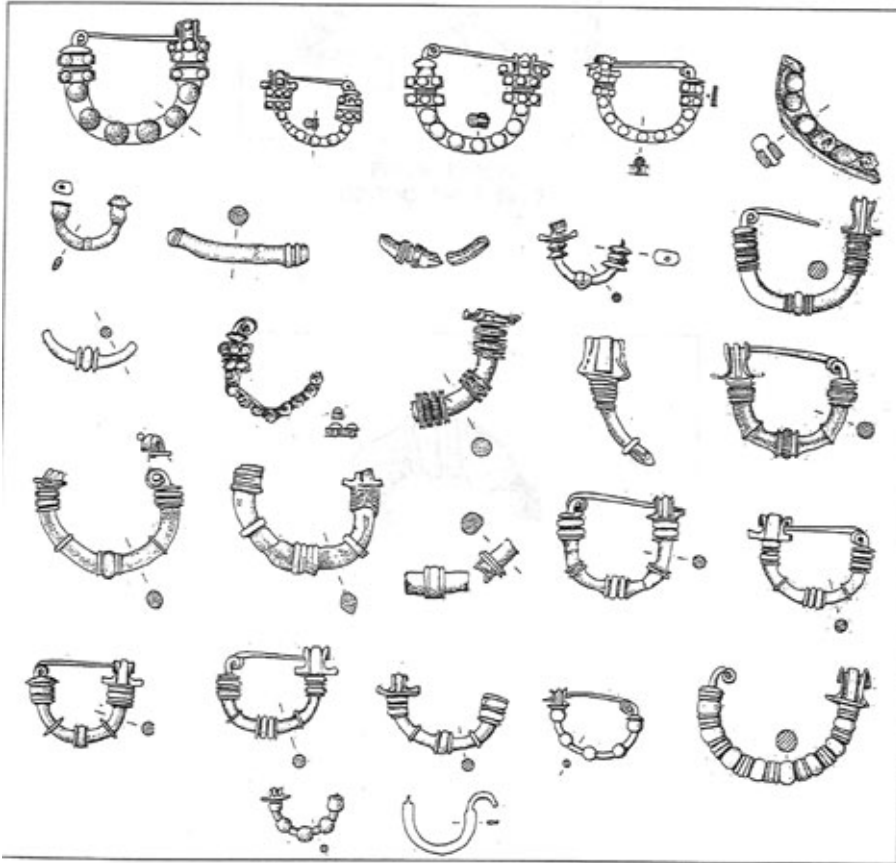

Pl. 452. Fibules, Kululu, Sultanhan⁴²³.

⁴²³ÖZGÜÇ, 1973, fig.7. EMRE, 1971, fig. 96.

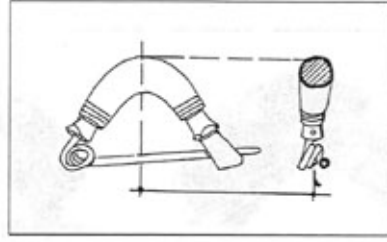

Fibule, Kulu.
ÖZGÜÇ, 1973, fig. 7.



Fibule, Sultanhan.
EMRE, 1971, Fig. 96.

Pl. 453. Fibules, épingle, pointe de flèche, pendentifs, Sultanhan⁴²⁴.

⁴²⁴EMRE, 1971, Pl. XI.



Pl. 454. Fibules, Kululu⁴²⁵.

⁴²⁵ÖZGÜÇ, 1973, pl. XIV.

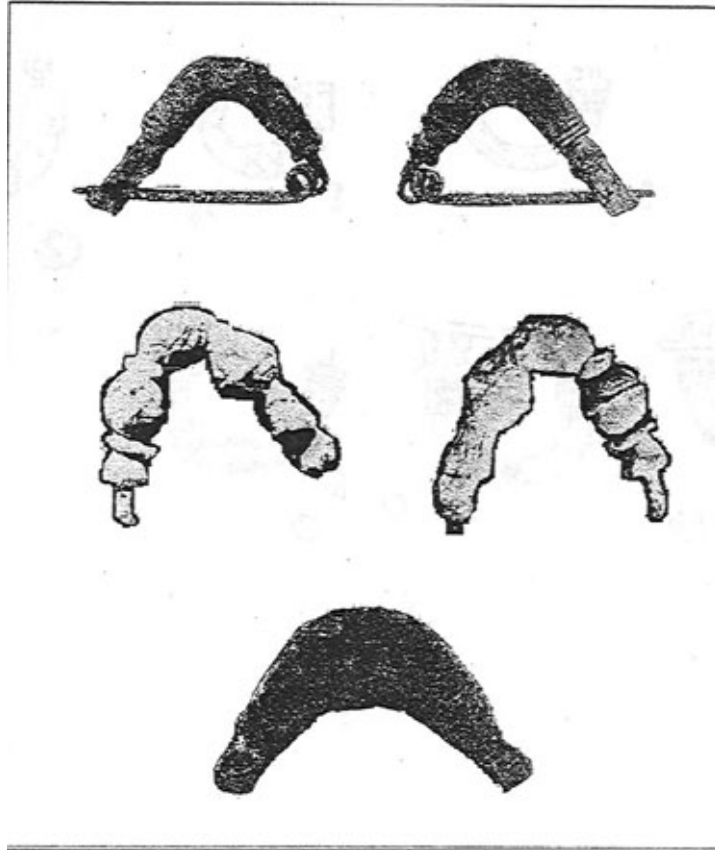

Pl. 455. Fibules, Kaman Kalehöyük⁴²⁶.

⁴²⁶MIKAMI, OMURA, 1991b, fig. 11. 1-12.

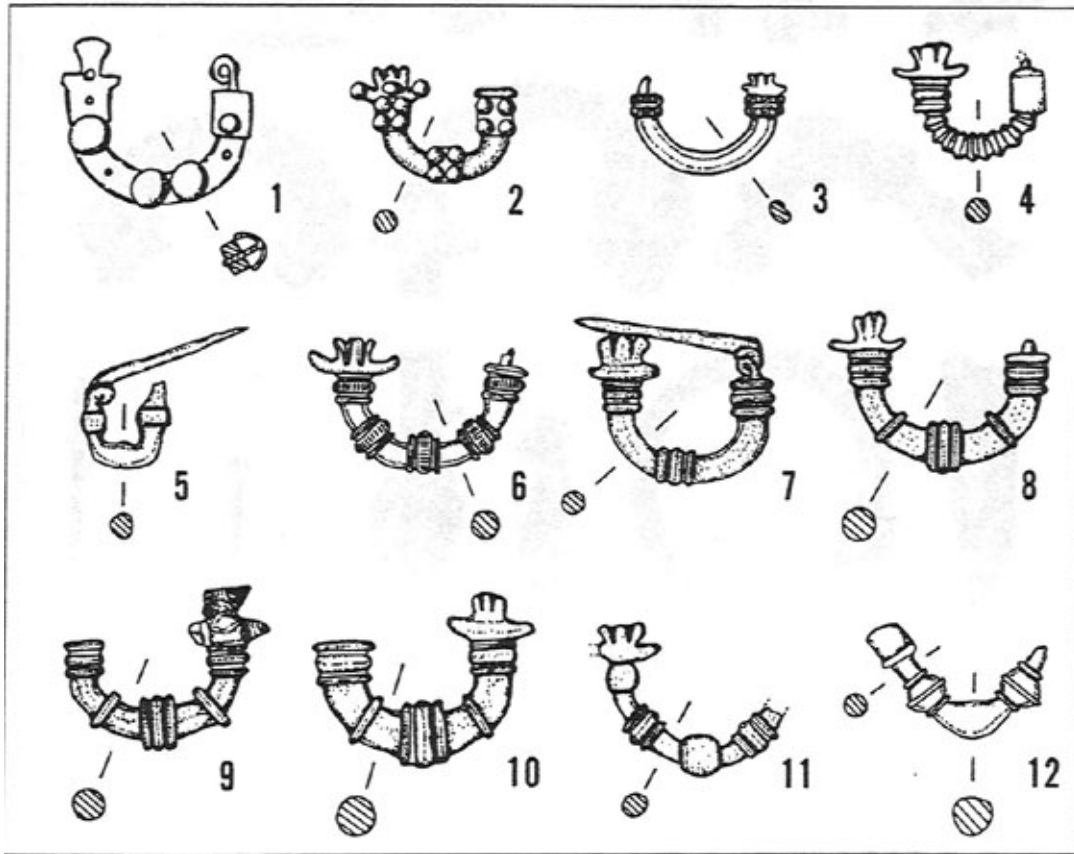

Pl. 456. Fibules, épingles, pointes de flèche, anneau, douille, passe-guides, Maşat⁴²⁷.

⁴²⁷ÖZGÜÇ, 1982, pl. 62.

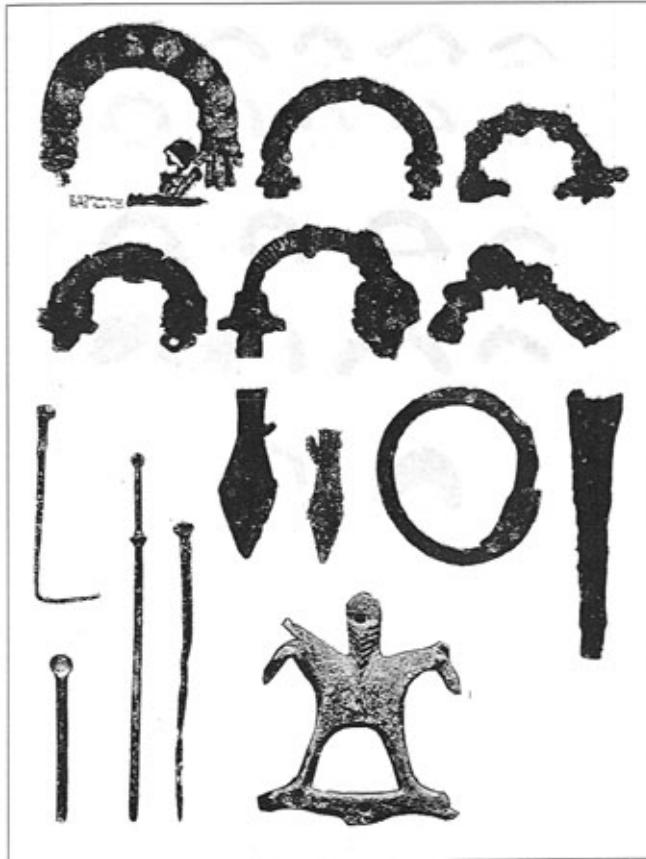

Pl. 457. Fibules, Alişar⁴²⁸.

⁴²⁸SCHMIDT, KROGMAN, 1933, fig. 93, 352-353. SCHMIDT, 1931, fig. 197.



Pl. 458. Pointes de flèches et fibules, Kaman⁴²⁹.

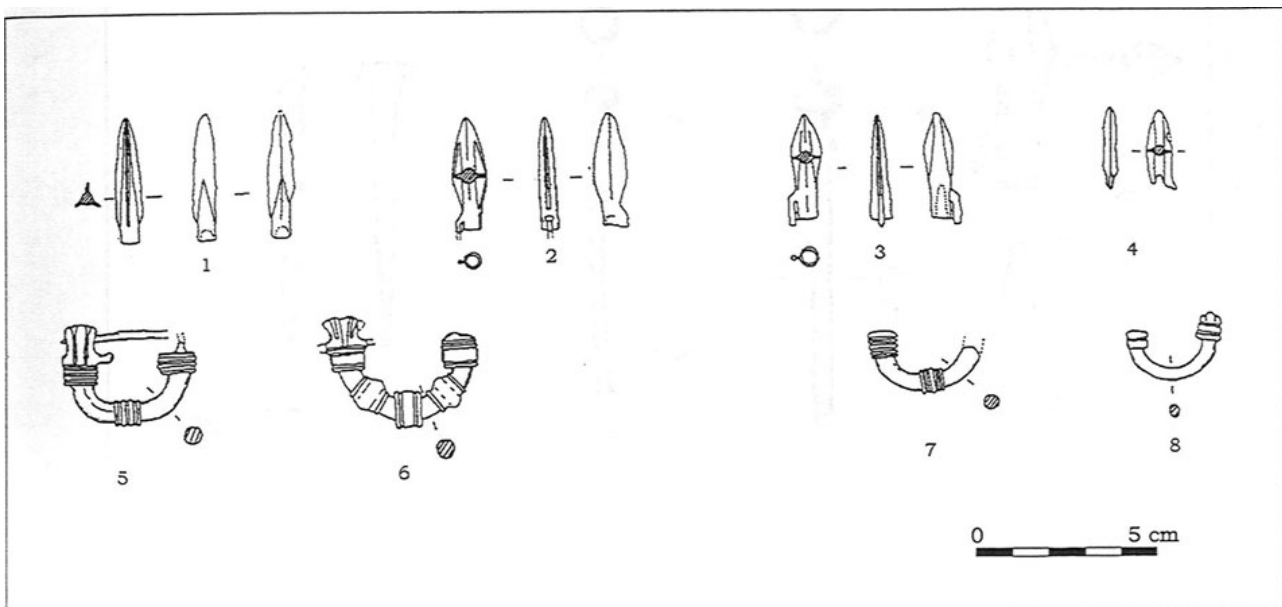

Pl. 459. Épingles, pointes de flèches et plaque ornementale, Kaman⁴³⁰.

⁴²⁹MIKAMI, OMURA, 1991b, fig. 15. 1-8.

⁴³⁰OMURA, 1995, fig. 16. 9-14.

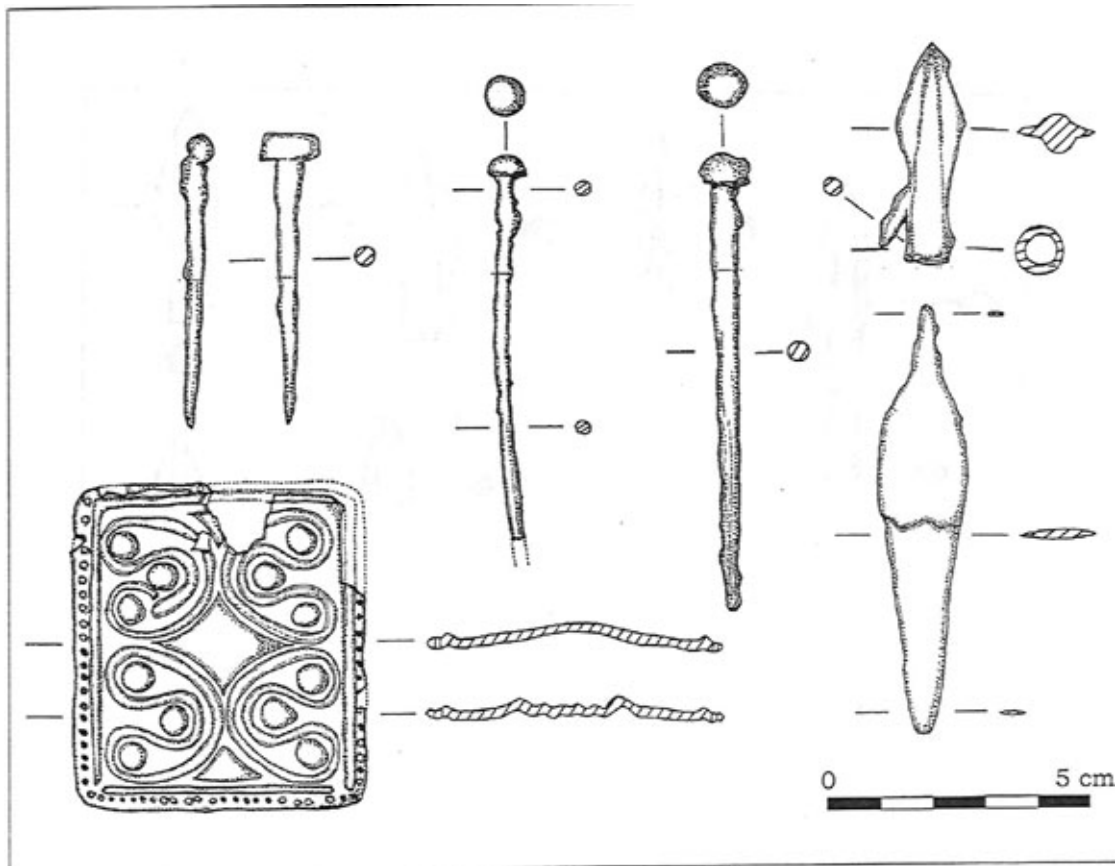

Pl. 460. Pointes de flèches, Kaman⁴³¹.

⁴³¹MIKAMI, OMURA, 1991b, fig. 11. 13-19.

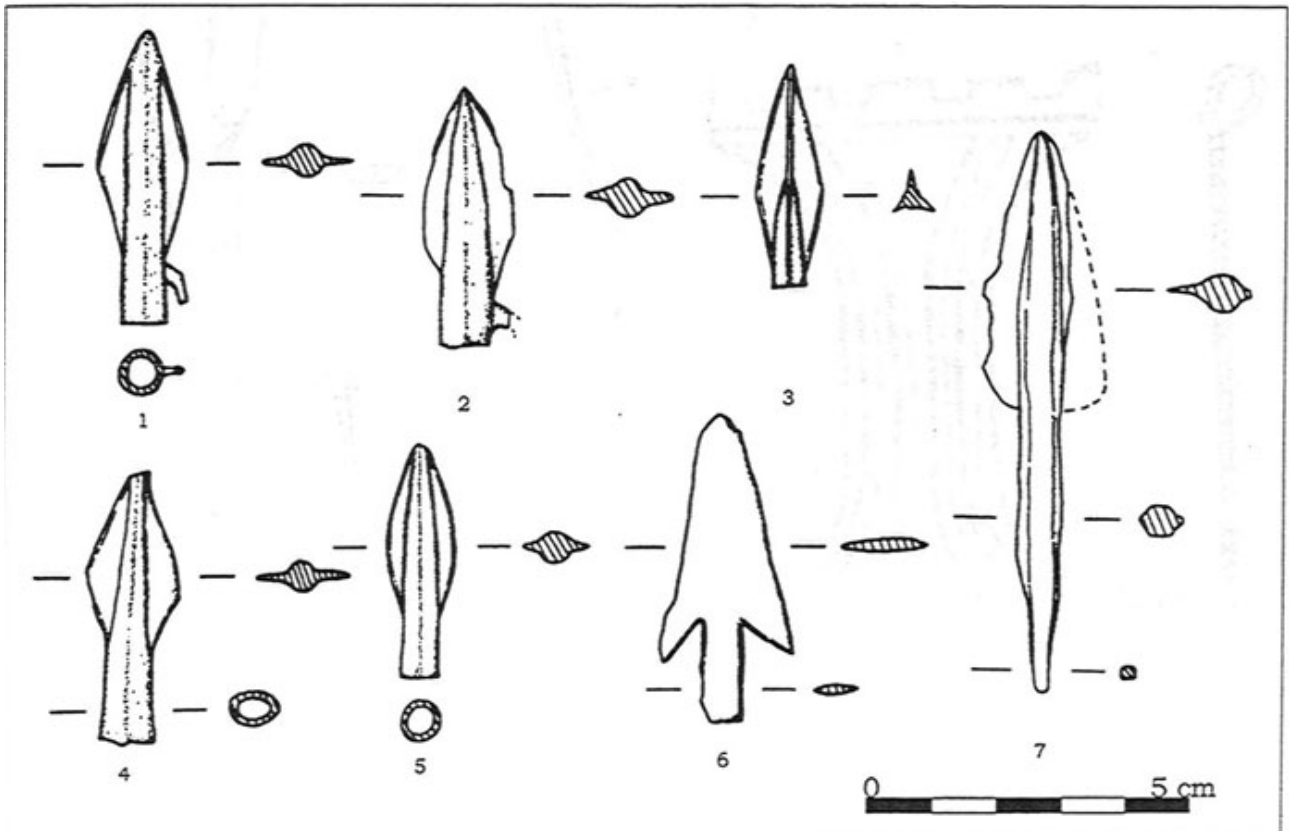

Pl. 461. Pointe de lance, aiguilles, épingles, plaque décorative, élément d'harnachement, Kaman⁴³².

⁴³²MIKAMI, OMURA, 1991b, fig. 12.

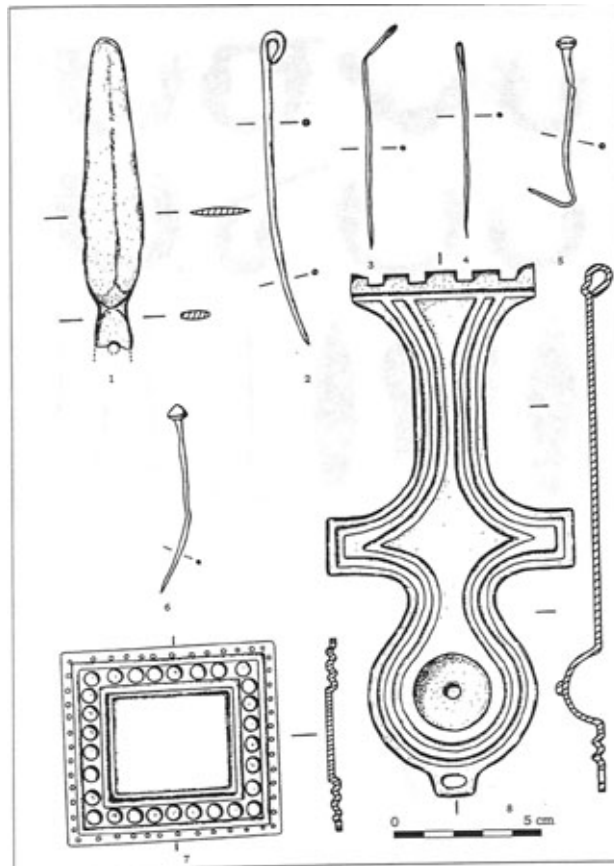

Pl. 462. Photographies des objets des planches 455, 460-461, 509⁴³³.

⁴³³MORI, OMURA, 1993, pl. 6.

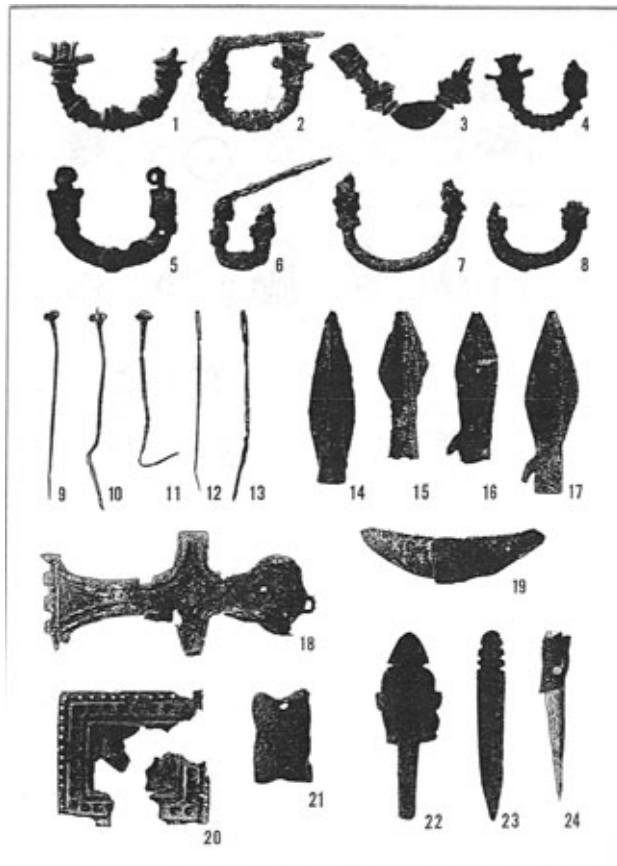

Pl. 463. Sceaux, bracelet, perles, objets en os, Kaman⁴³⁴.

⁴³⁴MIKAMI, OMURA, 1991b, fig. 14.

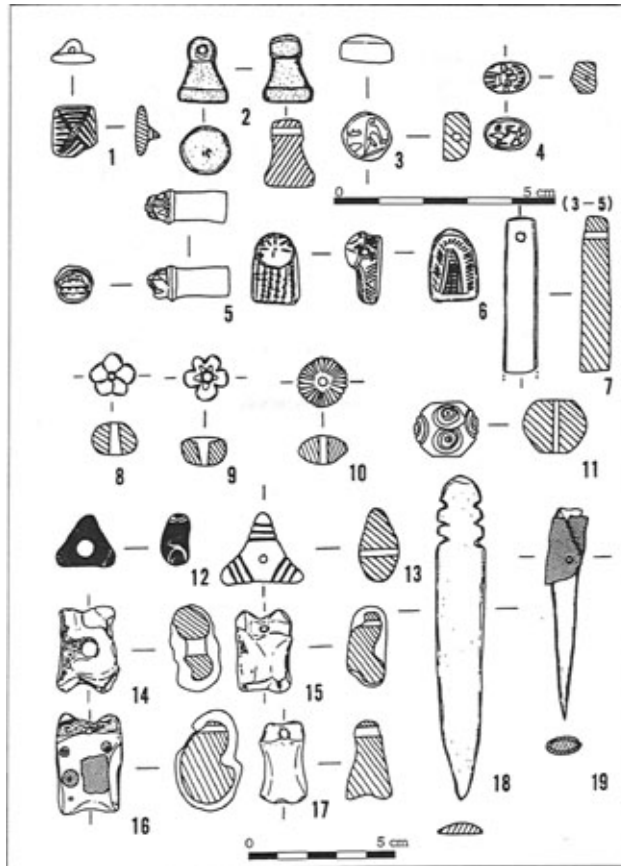

Pl. 464. Objets en os, pointes de flèche et moules, Kaman⁴³⁵.

⁴³⁵MORI, OMURA, 1993, fig. 12.1-5, 7-10.

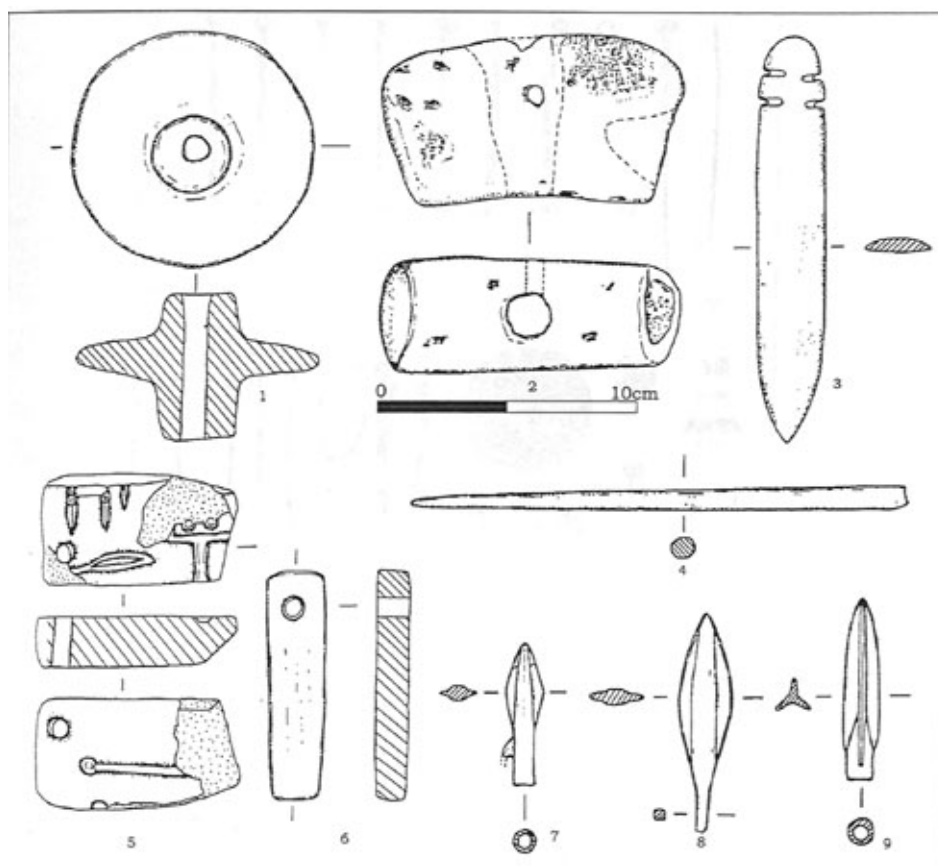

Pl. 465. Divers objets en bronze ou cuivre, Alişar⁴³⁶.

⁴³⁶SCHMIDT, KROGMAN, 1933, fig. 94-97.

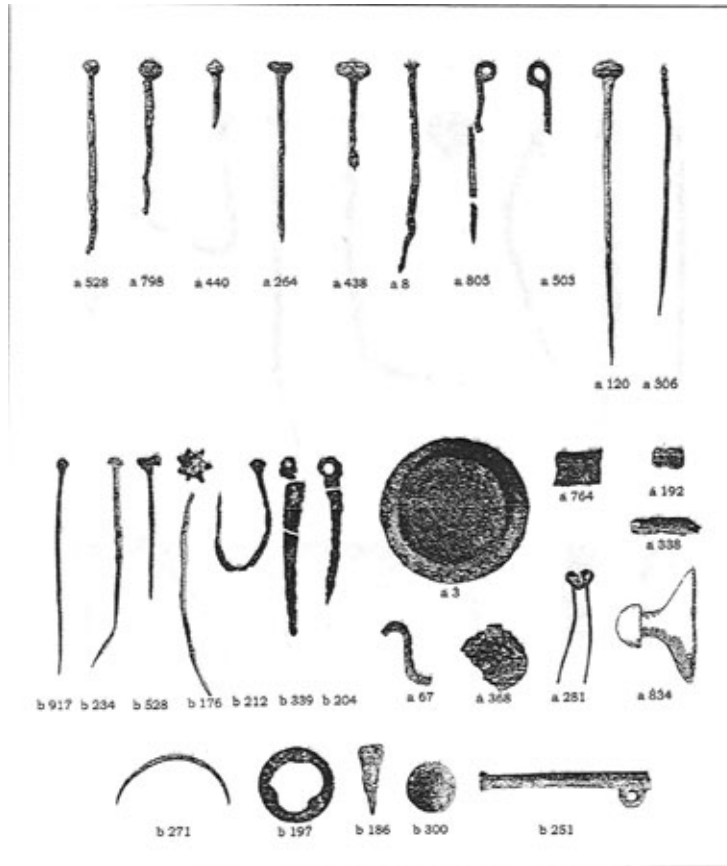

Pl. 466. Epingles, Alişar⁴³⁷.

⁴³⁷SCHMIDT, KROGMAN, 1933, fig. 354-355.

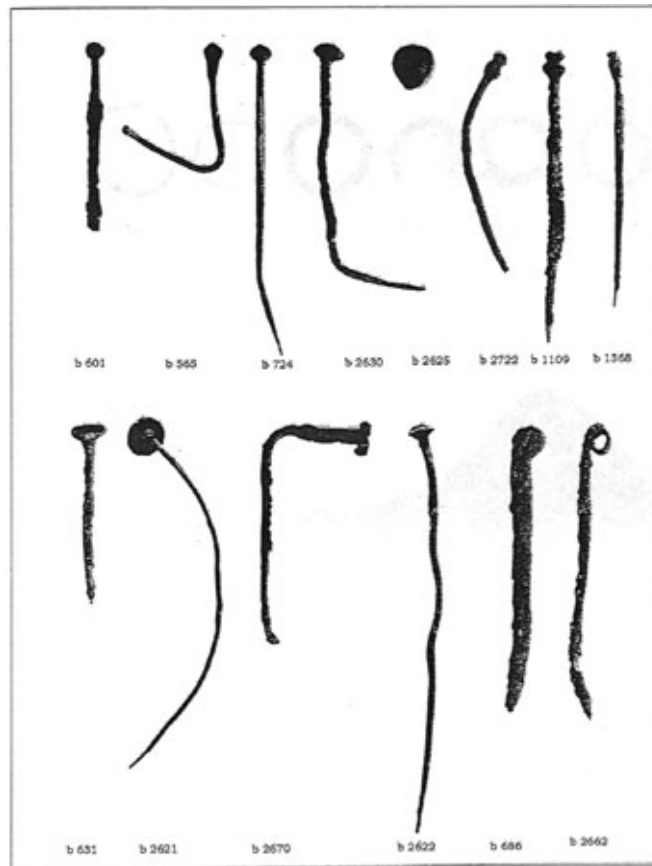

Pl. 467. Anneaux et hache, Alişar⁴³⁸.

⁴³⁸SCHMIDT, KROGMAN, 1933, fig. 351. SCHMIDT, 1931, fig. 198.

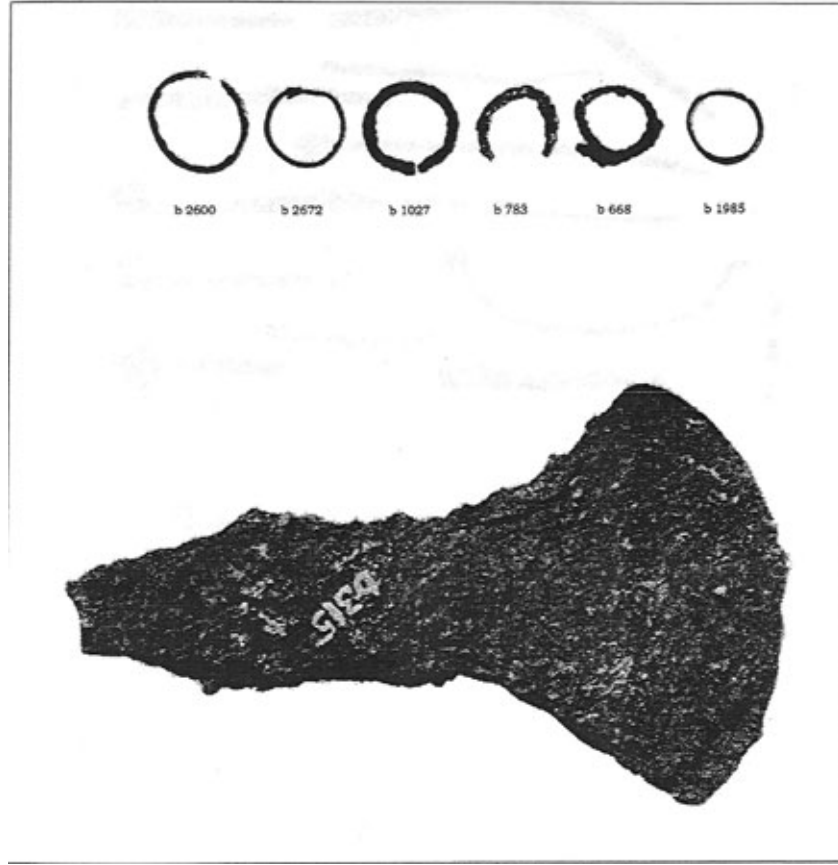

Pl. 468. Epingles, Karahöyük⁴³⁹.

⁴³⁹ÖZGÜÇ, 1949, Lev. XXXVII.

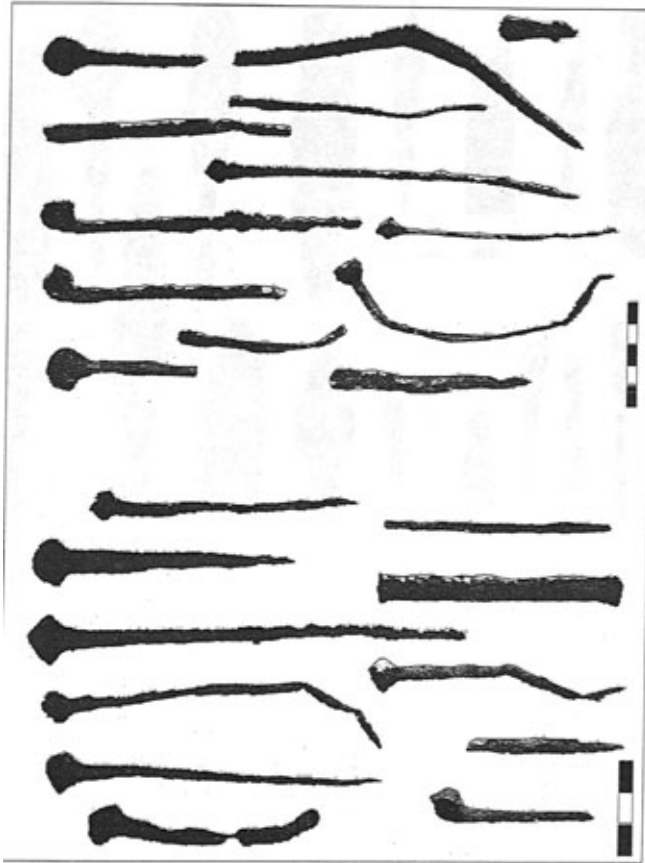

Pl. 469. Pointes de flèche et de lance, couteaux, petits outils, anse, anneau, bracelet et fibule, Karahöyük⁴⁴⁰.

⁴⁴⁰ÖZGÜÇ, 1949, Lev. XXXVI.

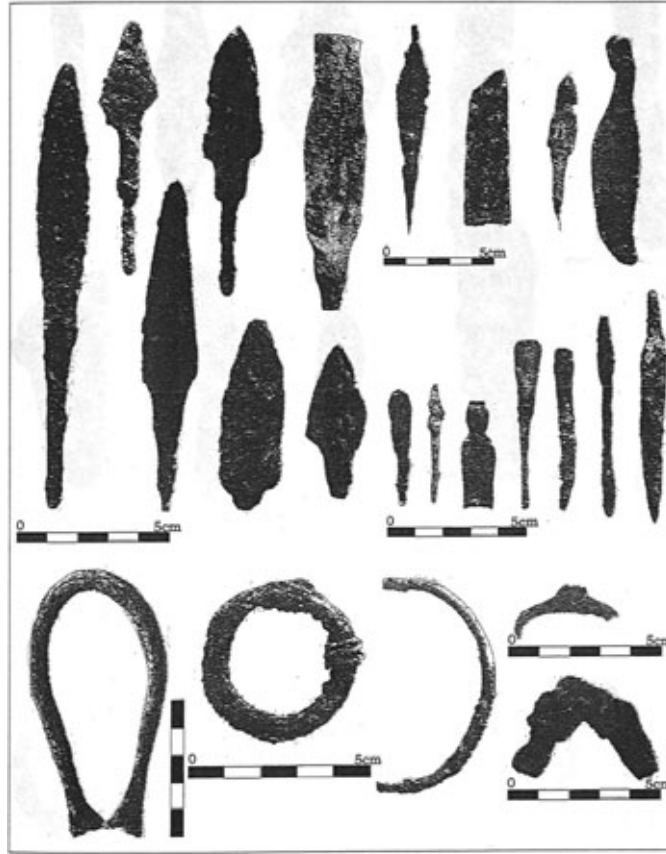

Pl. 470. Objets en métal, Karahöyük⁴⁴¹.

⁴⁴¹ÖZGÜÇ, 1949, Lev. XXXVIII.

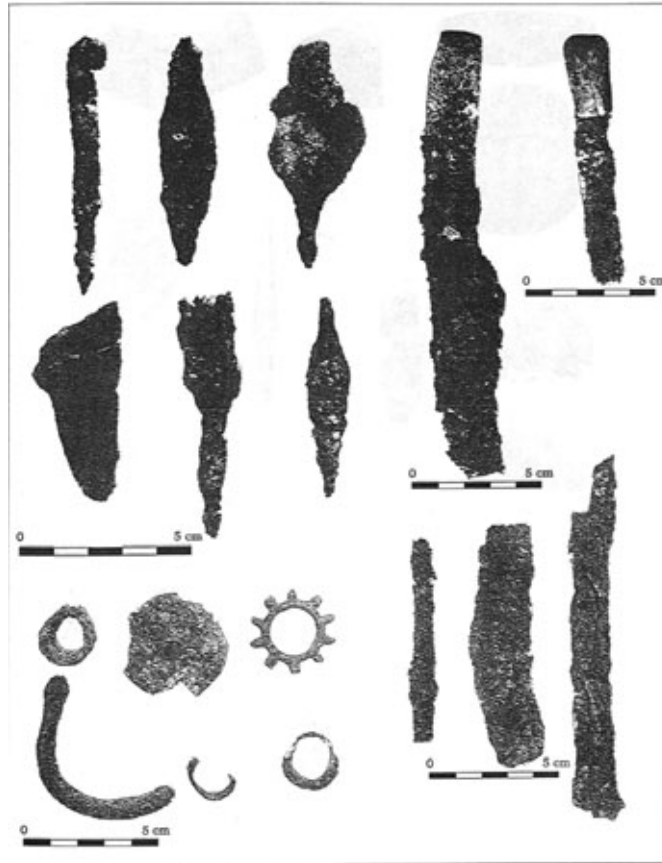

Pl. 471. Objets en céramique (vase inscrit), en pierre, en os, en métal (faucille, pointe de flèche, couteau, hache), Boğazköy⁴⁴².

⁴⁴²SCHIRMER, 1969, Abb. 169-174. BOSSERT, 1957, Abb. 57 b-c.

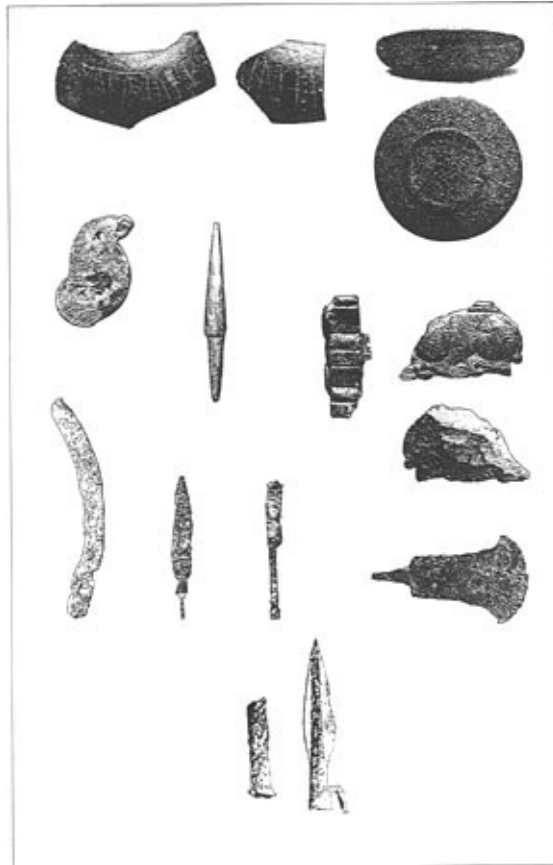

Pl. 472. Bouclier en bronze, Boğazköy⁴⁴³.

⁴⁴³BERAN, 1969, Abb. 12.

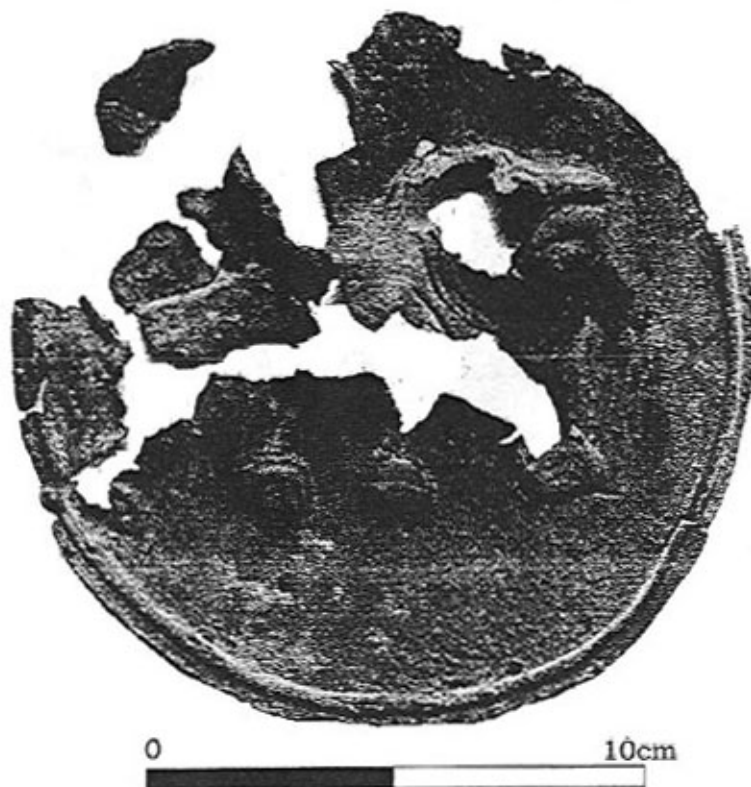

Pl. 473. Pointes de flèche et spatules, Alişar⁴⁴⁴.

⁴⁴⁴SCHMIDT, KROGMAN, 1933, fig. 89-90.

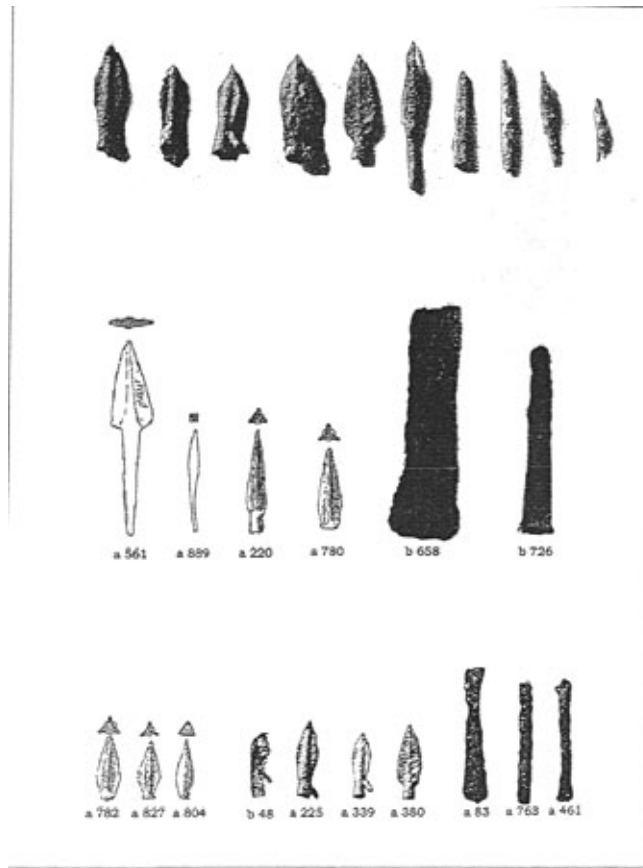

Pl. 474. Pointes de flèches, lames, fibule, anneau en fer, Alişar⁴⁴⁵.

⁴⁴⁵SCHMIDT, KROGMAN, 1933, fig. 359-362.

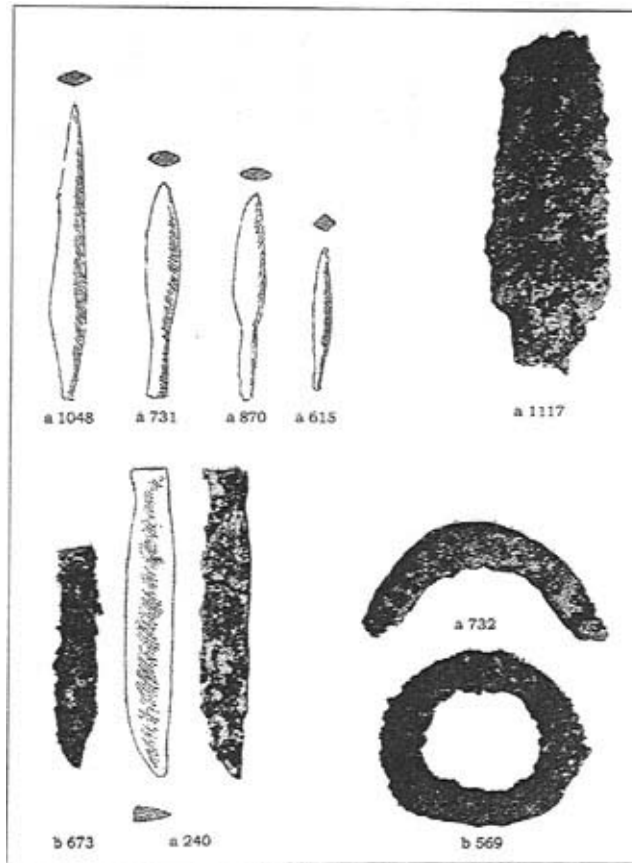

Pl. 475. Pointes, épingles, aiguilles, spatules, bracelet et anneau en bronze ou cuivre, Alişar⁴⁴⁶.

⁴⁴⁶SCHMIDT, KROGMAN, 1933, fig. 347, 91-92.

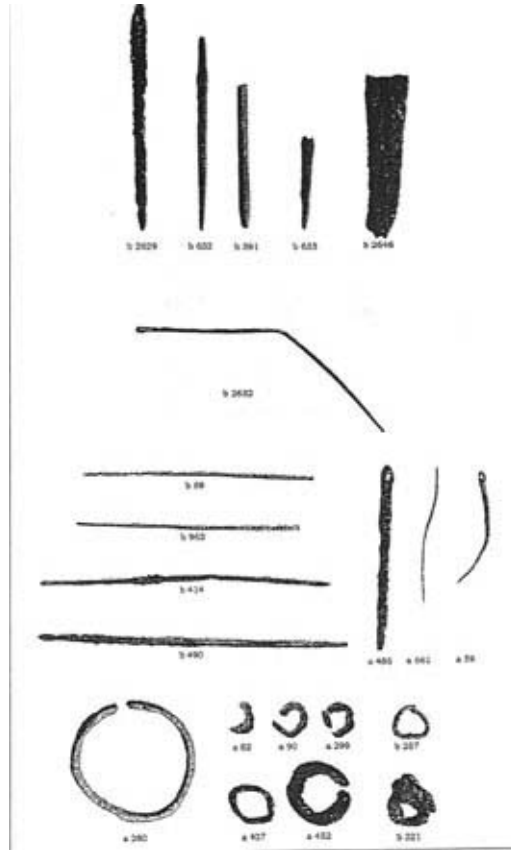

Pl. 476. Pointes de flèche, bracelet, pointe, Göllüdağ⁴⁴⁷.

⁴⁴⁷TEZCAN, 1992, Resim 32-33.

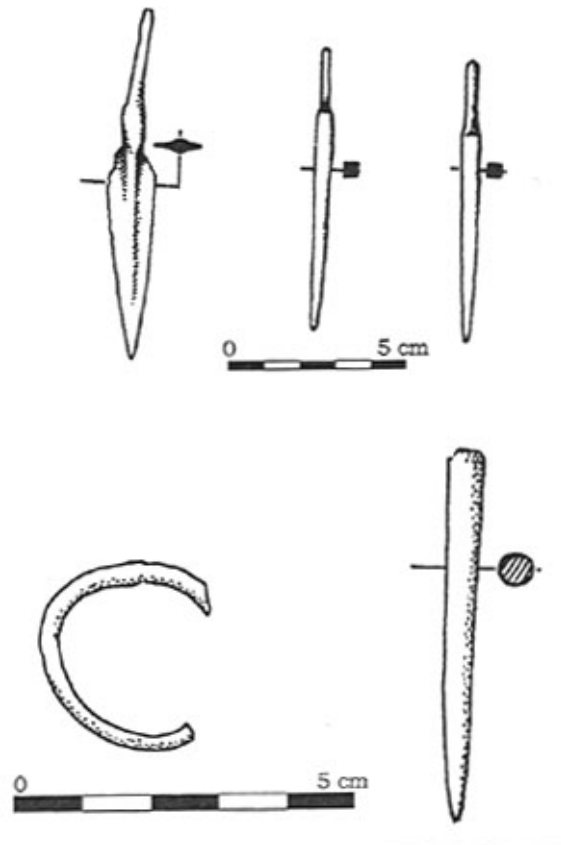

Pl. 477. Pointes de flèche, Kaman Kalehöyük⁴⁴⁸.

⁴⁴⁸OMURA, 1992, fig. 2.

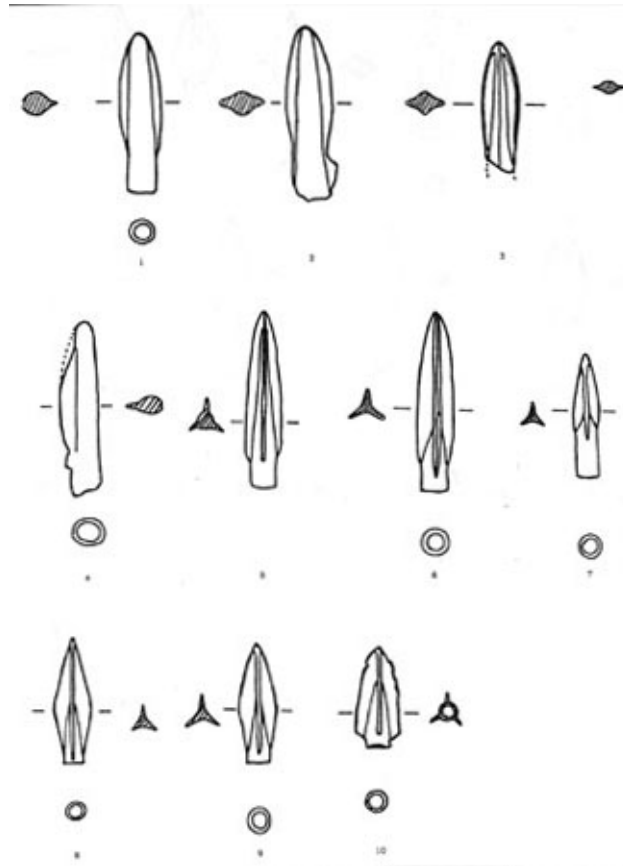

Pl. 478. Pointes de flèche, Kaman Kalehöyük⁴⁴⁹.

⁴⁴⁹OMURA, 1992, fig. 1.

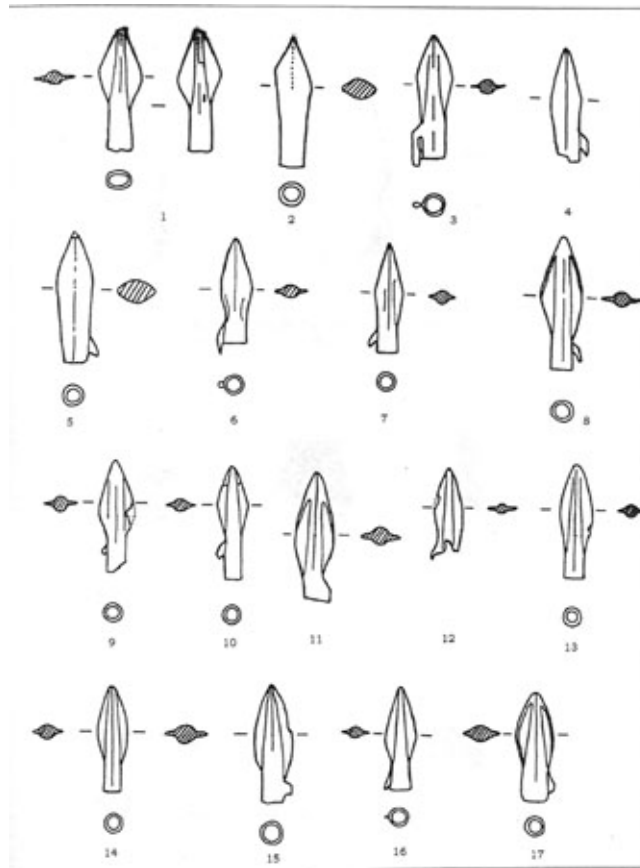

Pl. 479. Pointes de flèche, Sultanhan⁴⁵⁰.

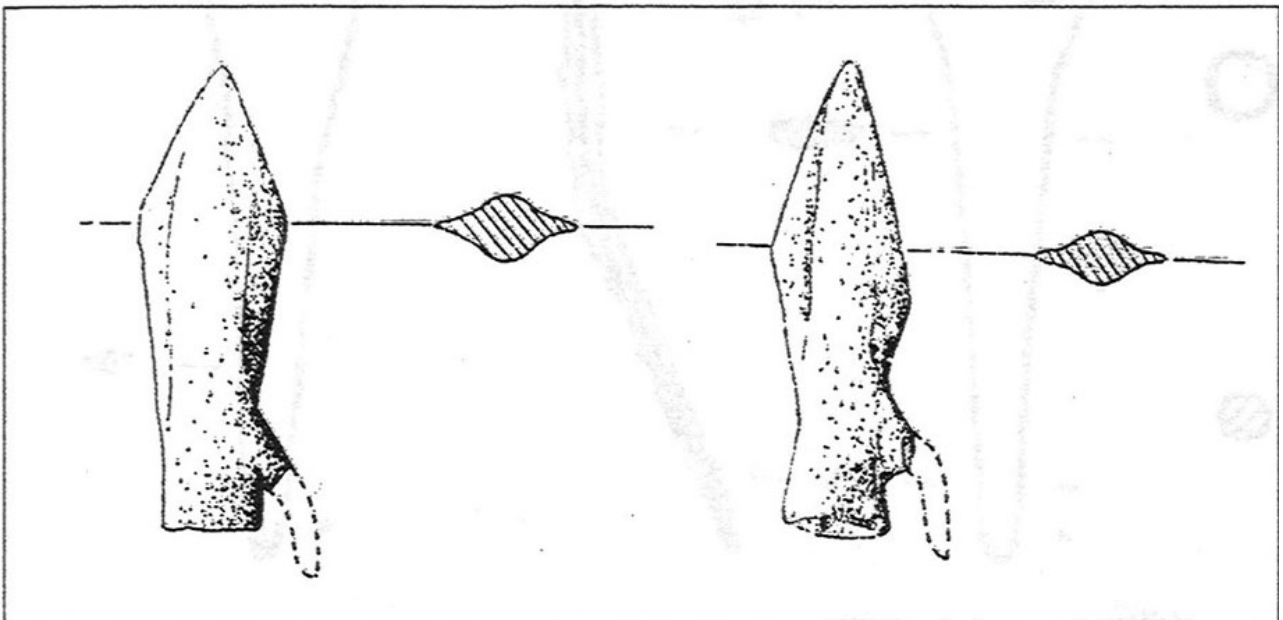

Pl. 480. Pointes de lance, Boğazköy⁴⁵¹.

⁴⁵⁰EMRE, 1971, fig. 97-98.

⁴⁵¹BERAN, 1963, Abb. 8.

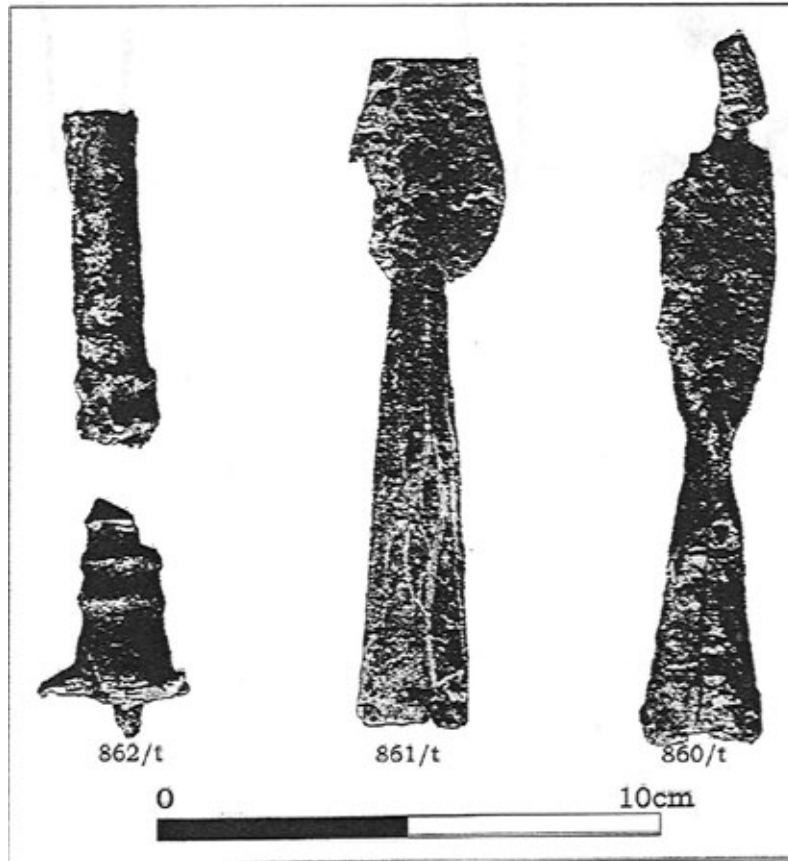

Pl. 481. Lames, pointes de lance, Kaman⁴⁵².

⁴⁵²OMURA, 1995, fig. 18.

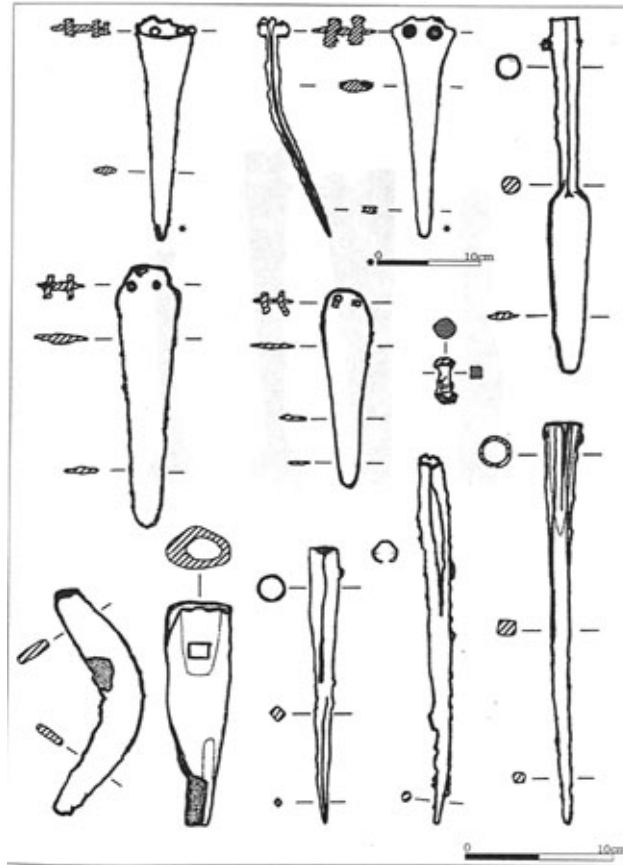

Pl. 482. Couteaux, pointes de lance, ciseau, Alişar⁴⁵³.

⁴⁵³von der OSTEN, 1930-31, fig. 30.

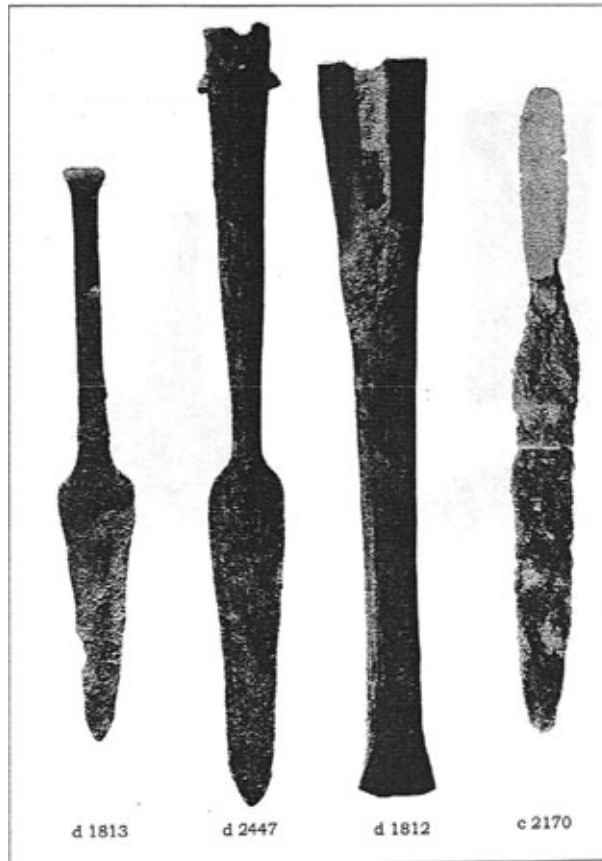

Pl. 483. Anse en bronze, panneau en marqueterie, *omphalos* en bronze, Gordion⁴⁵⁴.

⁴⁵⁴YOUNG, 1960, pl. 56. 5, 9-10.

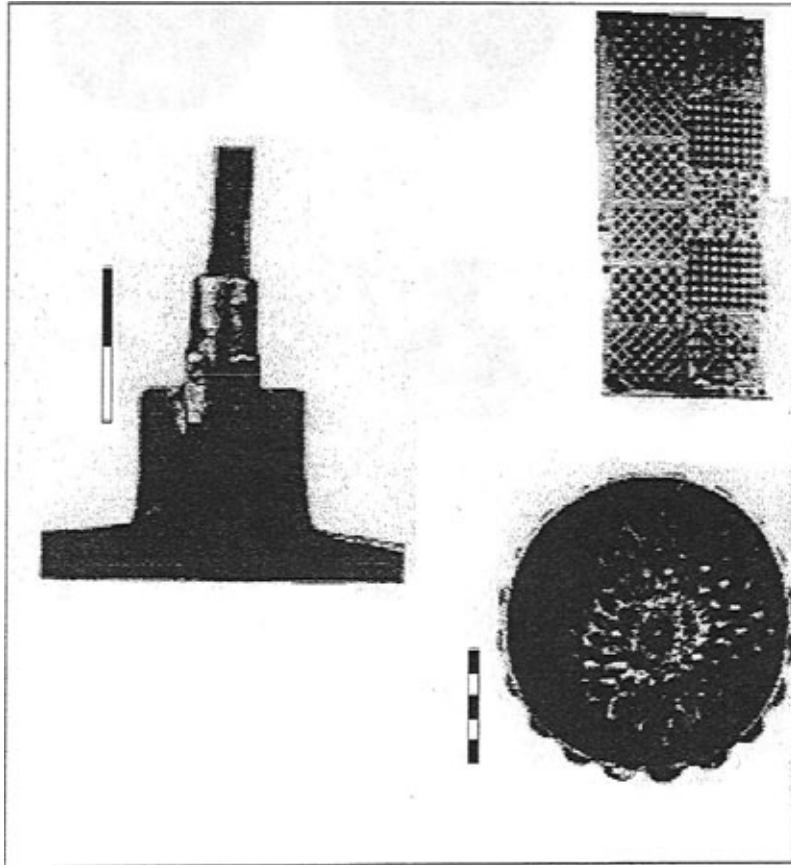

Pl. 484. Chaudrons, pichets à embouchure trilobée, *simpulum*, bassin, tumulus P, Gordion⁴⁵⁵.

⁴⁵⁵YOUNG, 1981, pl. 8.



Pl. 485. *Omphaloi*, tumulus P, Gordion⁴⁵⁶.

⁴⁵⁶YOUNG, 1981, pl. 9.

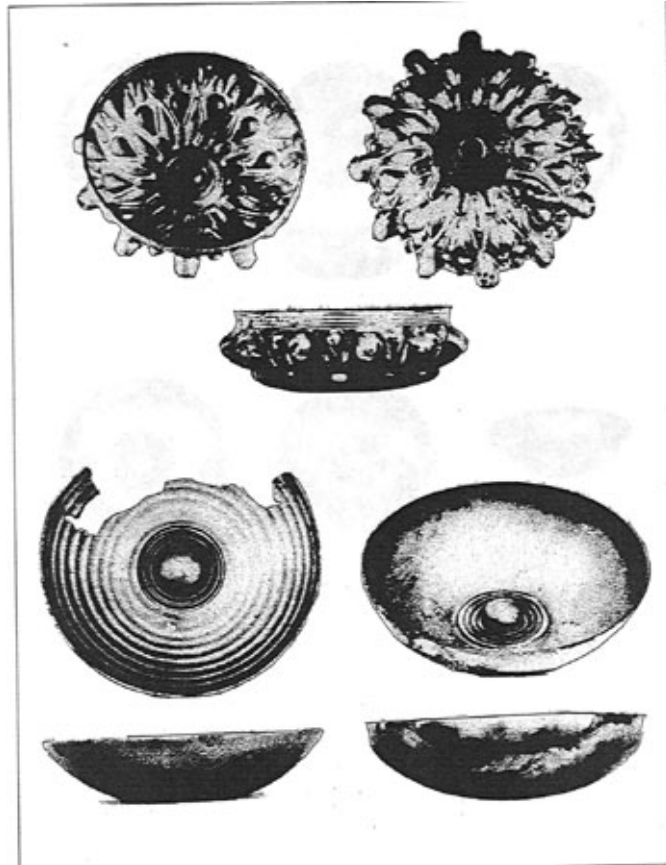

Pl. 486. *Omphaloi*, bols, bracelets, tumulus P, Gordion⁴⁵⁷.

⁴⁵⁷YOUNG, 1981, pl. 10.

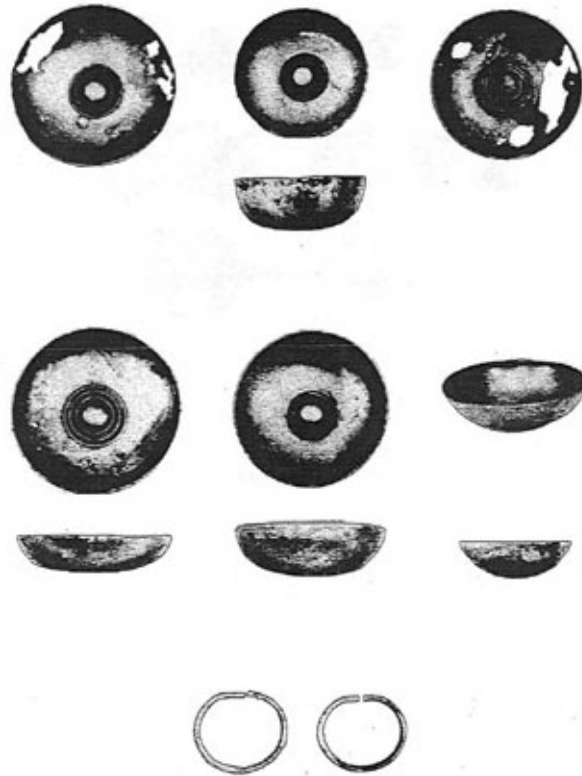

Pl. 487. Ceintures, tumulus P, Gordion⁴⁵⁸.

⁴⁵⁸YOUNG, 1981, pl. 11.

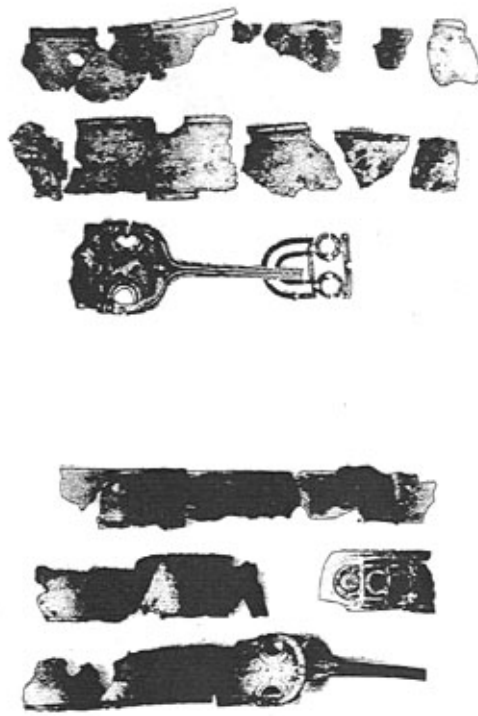

Pl. 488. Chaudrons, tumulus MM, Gordion⁴⁵⁹.

⁴⁵⁹YOUNG, 1981, pl. 58.

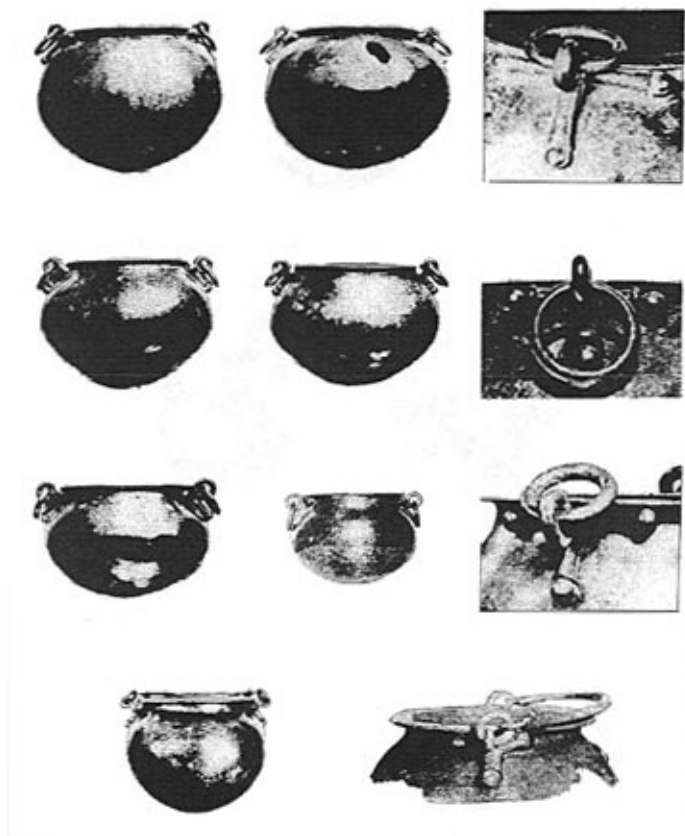

Pl. 489. Chaudrons et pichets à bec latéral, tumulus MM, Gordion⁴⁶⁰.

⁴⁶⁰YOUNG, 1981, pl. 59.



Pl. 490. Pichets à embouchure trilobée, tumulus MM, Gordion⁴⁶¹.

⁴⁶¹YOUNG, 1981, pl. 60.

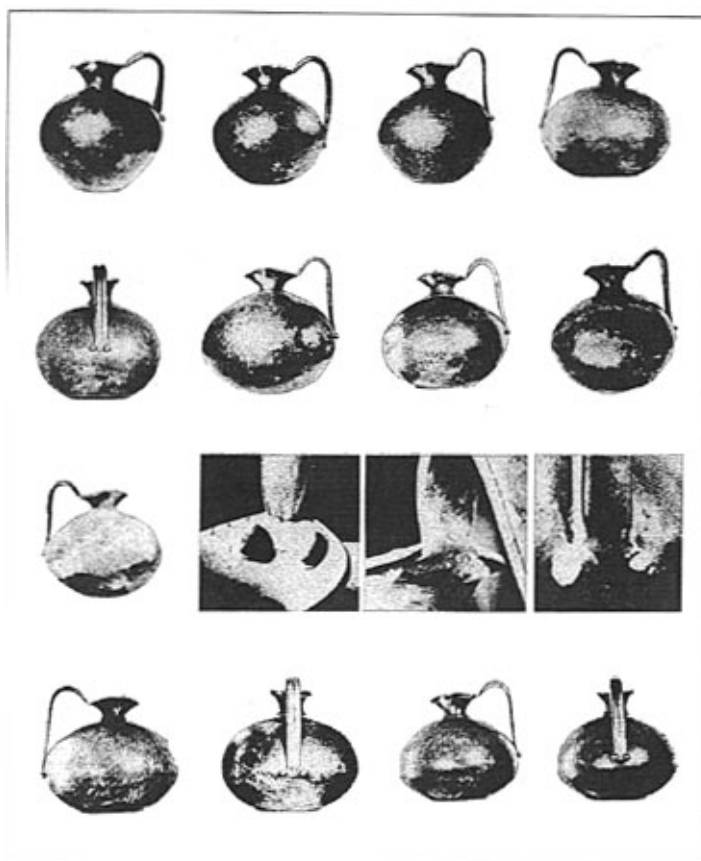

Pl. 491. Pichets à embouchure trilobée, tumulus MM, Gordion⁴⁶².

⁴⁶²YOUNG, 1981, pl. 61.



Pl. 492. *Simpulum*, bassins, tumulus MM, Gordion⁴⁶³.

⁴⁶³YOUNG, 1981, pl. 64.



Pl. 493. *Omphaloi*, tumulus MM, Gordion⁴⁶⁴.

⁴⁶⁴YOUNG, 1981, pl. 68.

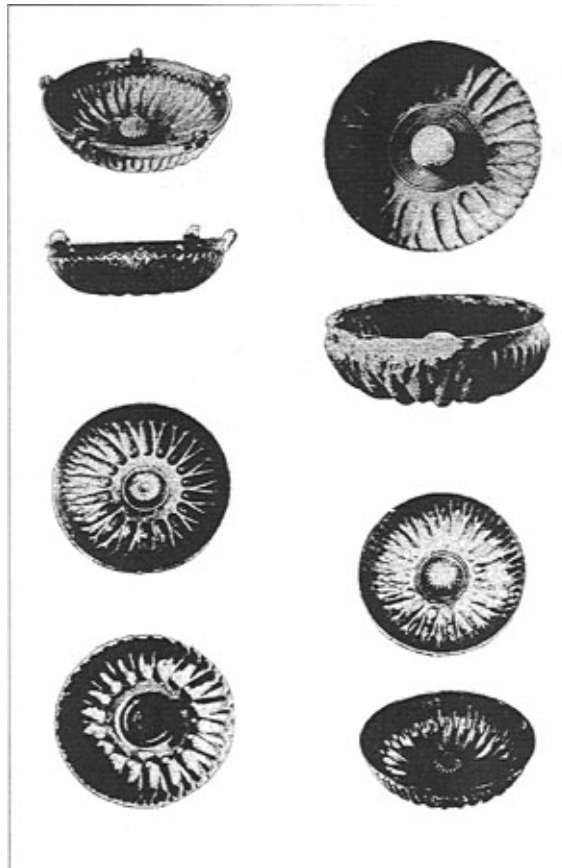

Pl. 494. Matériel en bronze provenant d'un tumulus, Kaynarca⁴⁶⁵.

⁴⁶⁵AKKAYA, 1987, pl. I.



Pl. 495. Objets en fer, Alişar⁴⁶⁶.

⁴⁶⁶SCHMIDT, KROGMAN, 1933, fig. 103-108.

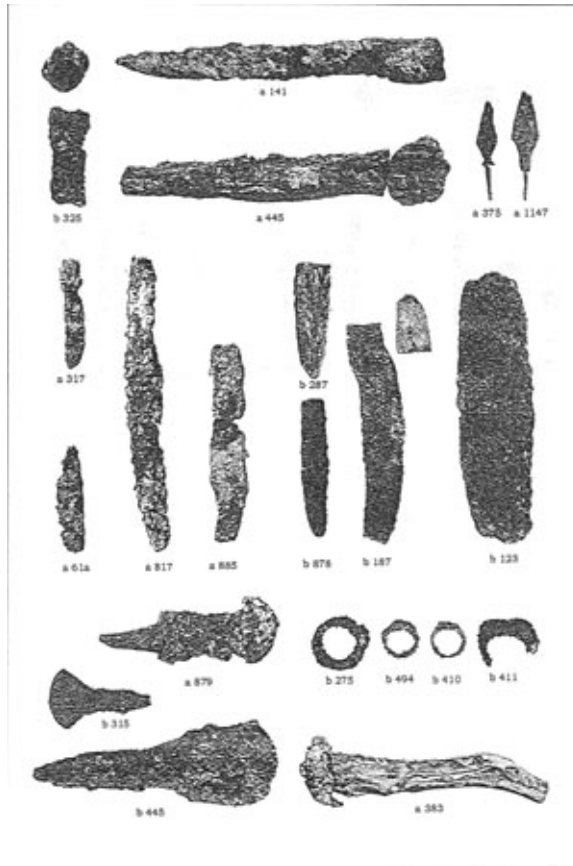

Pl. 496. Objets en fer, Alişar⁴⁶⁷.

⁴⁶⁷SCHMIDT, KROGMAN, 1933, fig. 98-102.

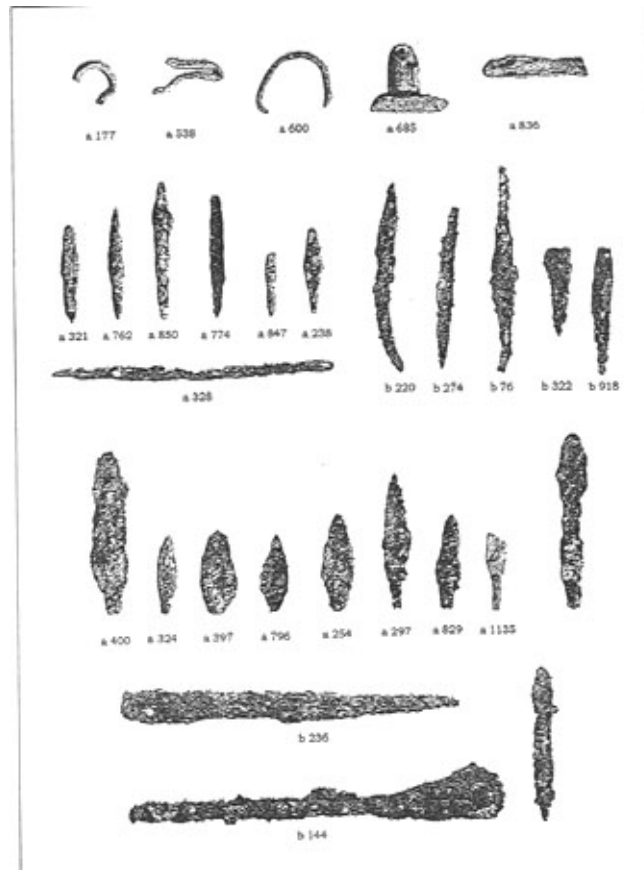

Pl. 497. Objets en os, Hacibektaş⁴⁶⁸.

⁴⁶⁸BALKAN, SÜMER, 1969, Res. 13-15.

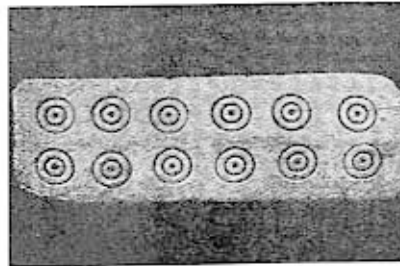
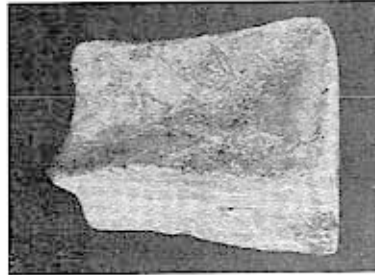
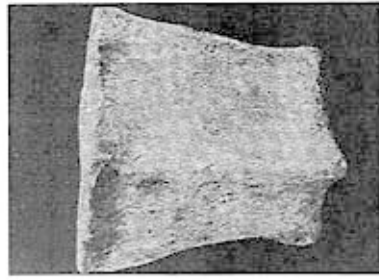

Pl. 498. Tubes, pointes, attaches, poinçons en os, Alişar⁴⁶⁹.

⁴⁶⁹SCHMIDT, KROGMAN, 1933, fig. 123-126.

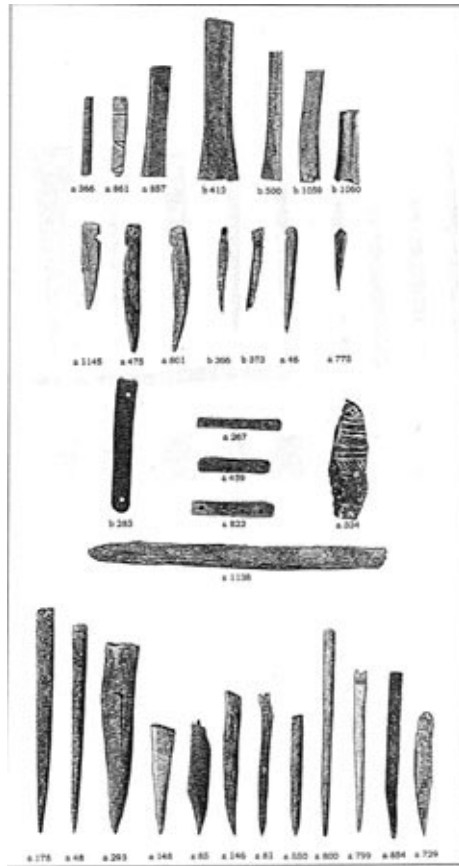

Pl. 499. Poinçons, pointes, osselets percés, perles, disques, épingle à décor d'oiseau, Alişar⁴⁷⁰.

⁴⁷⁰SCHMIDT, KROGMAN, 1933, fig. 127-130.

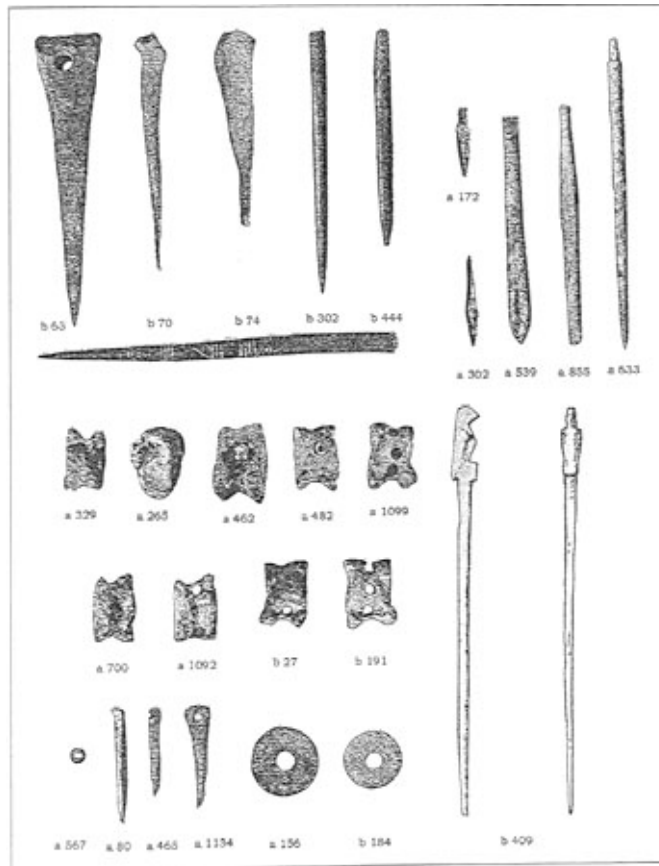

Pl. 500. Objets en os et perles de verre, Alişar⁴⁷¹.

⁴⁷¹SCHMIDT, KROGMAN, 1933, fig. 131-133.



Pl. 501. Élément de harnachement en ivoire, Gordion⁴⁷².

⁴⁷²SAMS, 1993, pl. 95.



Pl. 502. Élément de harnachement en ivoire, Gordion⁴⁷³.

⁴⁷³SAMS, 1993, pl. 96.



Pl. 503. Plaque avec un griffon et chevaux en ronde bosse en ivoire⁴⁷⁴.

⁴⁷⁴SAMS, 1993, pl. 94, 3-4.

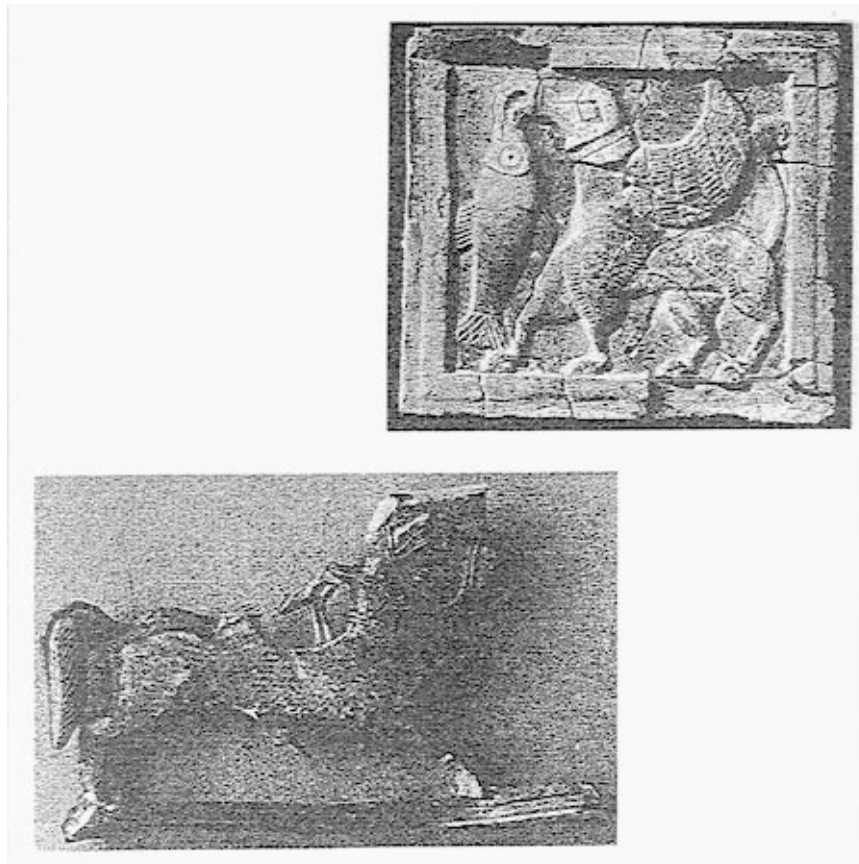

Pl. 504. Tableau des datations dendrochronologiques obtenues en 1988⁴⁷⁵.

Structure	Date Traditionnelle	N°	Début	Fin
Gordion MM ¹	VIII ^e siècle	GOR 1	1333p	1416v
Gordion MM ²	VIII ^e siècle	GOR-43	1334p	1561+vvv
Gordion MM ³	VIII ^e siècle	GOR 44		
Gordion MM ⁴	VIII ^e siècle	GOR 75	1372p	1572+vvv
Gordion MM ⁵	VIII ^e siècle	GOR-2-20-36	959	1764vv
Gordion P ¹	VIII ^e siècle	GOR 67/70/71		
Gordion II ¹	VIII ^e siècle	GOR 74		
Gordion II ²	VIII ^e siècle	GOR-27-40-41-42		
Gordion Megaron 6	Fin VIII ^e siècle	GOR-32		
Gordion Megaron 5	Fin VIII ^e siècle	GOR-31		
Gordion Megaron 4	Fin VIII ^e siècle	GOR-30	1452	1594vv
Gordion Megaron 3	Fin VIII ^e siècle	GOR-22		
Gordion TB 7A	VIII ^e -VIII ^e siècles	GOR-38		
Bâtiment semi-souterrain 36	VIII ^e -VIII ^e siècles	GOR 36/68		
Bâtiment semi-souterrain 37	VIII ^e -VIII ^e siècles	GOR-62	1305	1436vv
Bâtiment semi-souterrain 38	VIII ^e -VIII ^e siècles	GOR 66	1258	1426+vvv
Bâtiment semi-souterrain 39	VIII ^e -VIII ^e siècles	GOR 67	1309	1431+vvv
Fondation porte perissée ¹	VII ^e siècle	GOR 4	1258c	1455+vvv
Fondation porte perissée ²	VII ^e siècle	GOR-5	1254c	1425vv
Fondation porte perissée ³	VII ^e siècle	GOR-6	1309	1582+2000 ⁴
Ankara Boyuk Tumukte	VII ^e siècle	ANK 1		
Ankara Boyuk Tumukte	VII ^e siècle	ANK-2		
Ankara Boyuk Tumukte	VII ^e siècle	ANK-3	1360	1648vv
Bobak ⁵	VIII ^e -VIII ^e siècles	BOG 1		
Bobak ⁶	VIII ^e -VIII ^e siècles	BOG 2		
Bobak ⁷	VIII ^e -VIII ^e siècles	BOG 3		
Ayvan Döşmezarfunda	VII ^e siècle	Dön-master		
İçlaik	Azchaqlar ⁸	IUG		

- ¹ Structure interne de la chambre
- ² Structure interne de la chambre
- ³ Structure interne de la chambre
- ⁴ Structure interne de la chambre
- ⁵ Structure externe de la chambre
- ⁶ Gordion, bâtiment creusé dans de l'argile
- ⁷ Gordion, bâtiment creusé dans de l'argile
- ⁸ Gordion, bâtiment creusé dans de l'argile
- ⁹ Gordion, bâtiment creusé dans de l'argile
- ¹⁰ Gordion
- ¹¹ Gordion
- ¹² Reutilisé quatre cents ans après la coupe

⁴⁷⁵KUNIHOLM, 1988, 6-7.

Pl. 505. Tables de service, tumulus MM, Gordion⁴⁷⁶.

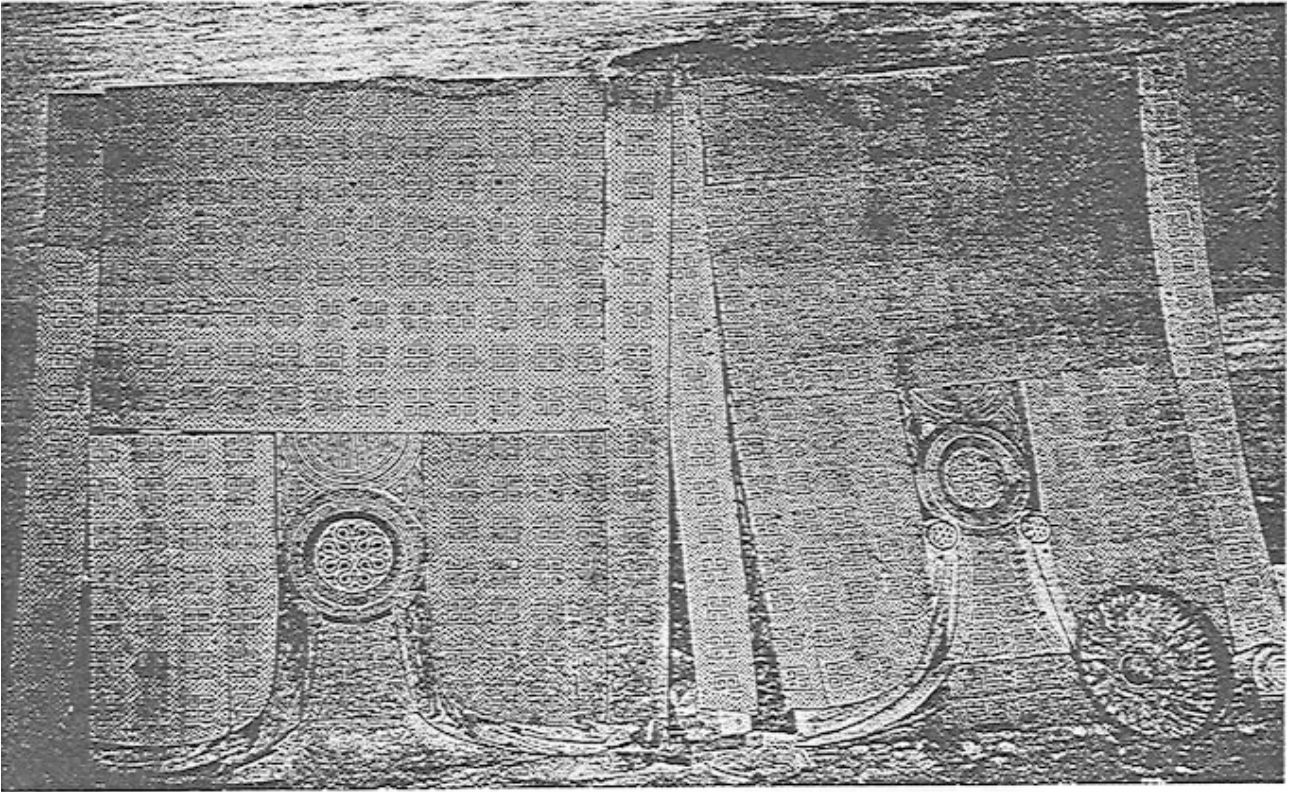

Pl. 506. Table de banquet portable, tumulus MM, Gordion⁴⁷⁷.

⁴⁷⁶SIMPSON, 1988, fig. 1.

⁴⁷⁷SIMPSON, 1988, fig. 2, 13.

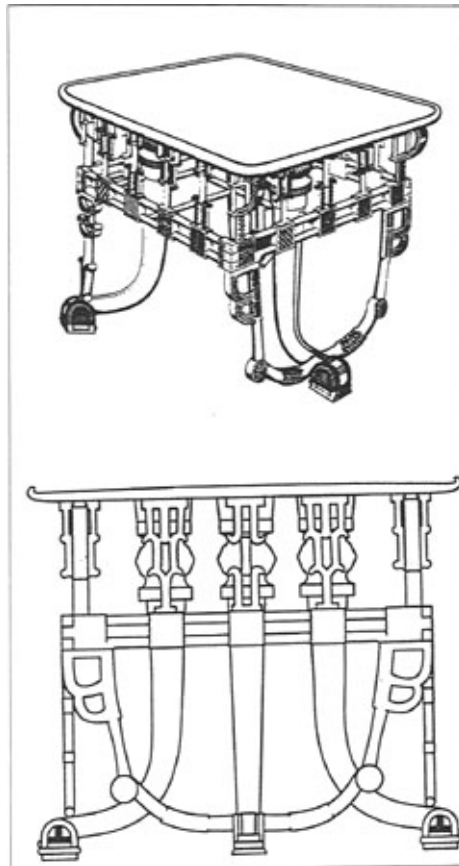

Pl. 507. Reconstruction de l'une des tables de service, tumulus P, Gordion⁴⁷⁸.

⁴⁷⁸SIMPSON, 1988, fig. 3.

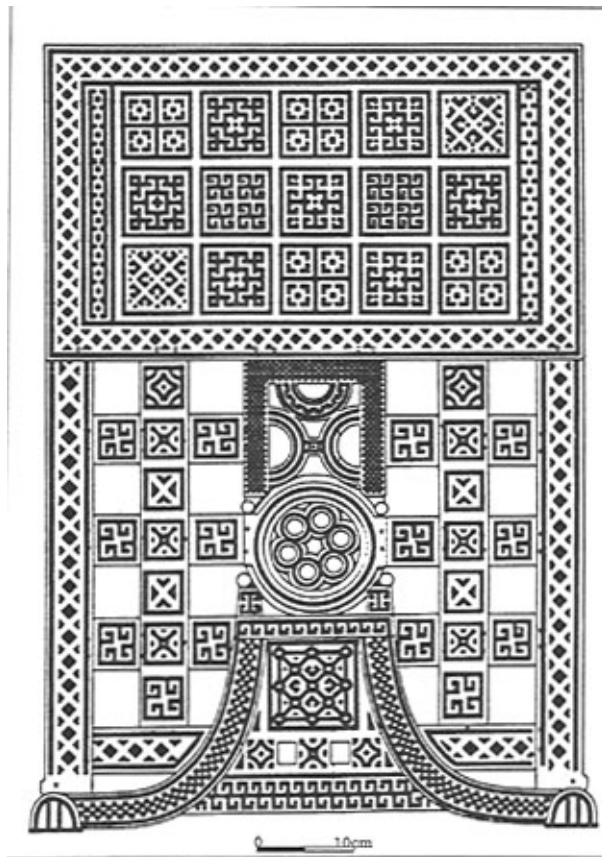

Pl. 508. Tabouret, tumulus P, Gordion⁴⁷⁹.

⁴⁷⁹SIMPSON, 1988, fig. 4-5.

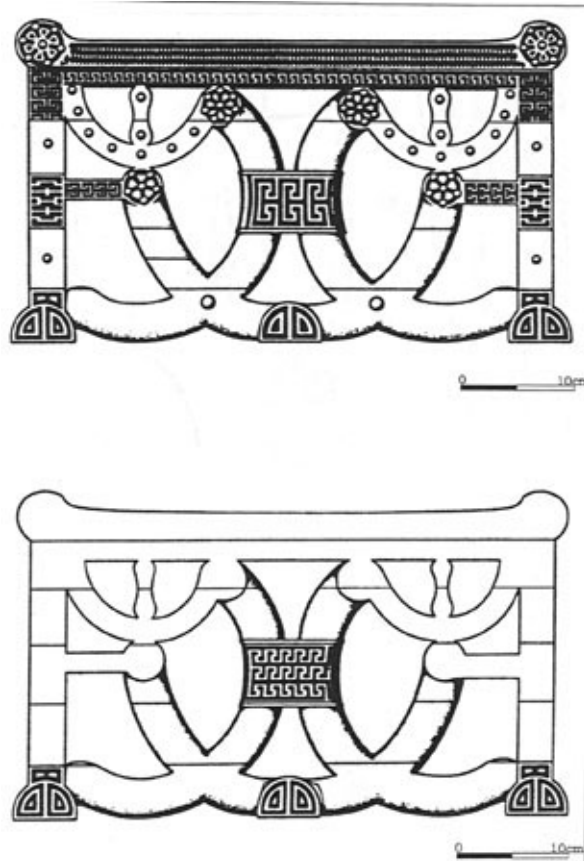

Pl. 509. Objets en fer, en os et en terre-cuite, Kaman Kalehöyük⁴⁸⁰.

⁴⁸⁰MIKAMI, OMURA, 1991b, fig. 13.

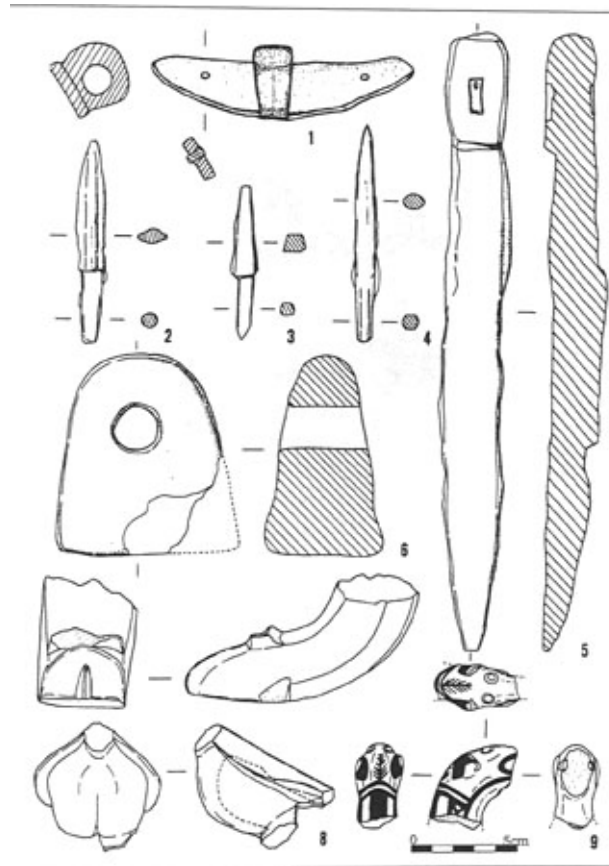

Pl. 510. Objets en terre-cuite avec animal couché, tête de taureau, pied et fragment de vase, Boğazköy⁴⁸¹.

⁴⁸¹SCHIRMER, 1969, fig. 161, 166-168.

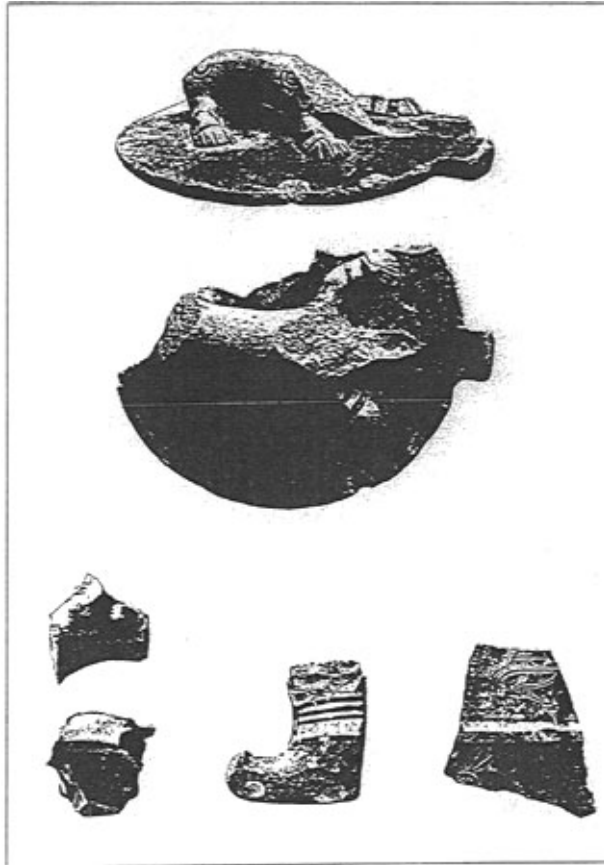

Pl. 511. Oiseau provenant du temple I, Boğazköy⁴⁸².

⁴⁸²BERAN, 1963, Abb. 9-10.

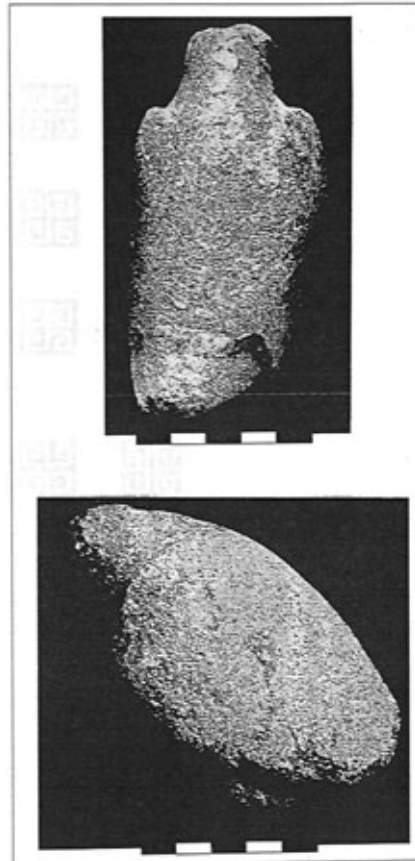

Pl. 512. Les trois motifs principaux de la table de service A, tumulus MM, Gordion⁴⁸³.

⁴⁸³SIMPSON, 1988, fig. 7.

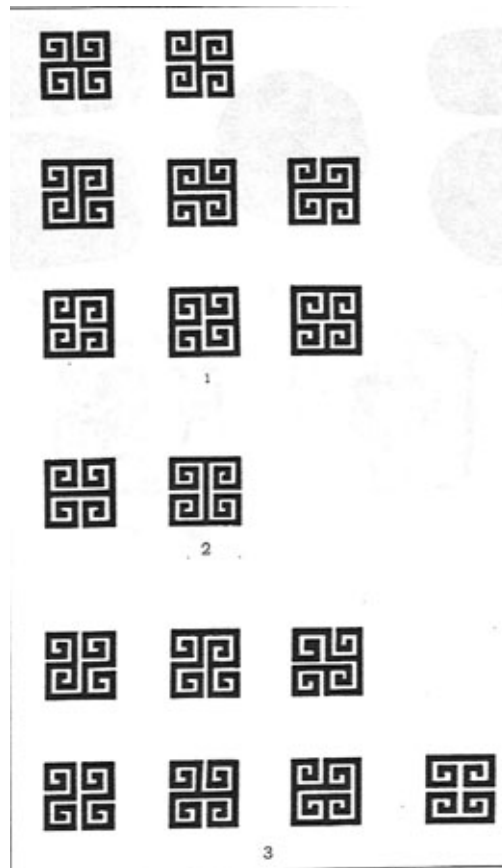

Pl. 513. Objets en pierre, Alişar⁴⁸⁴.

⁴⁸⁴SCHMIDT, KROGMAN, 1933, fig. 115-116.

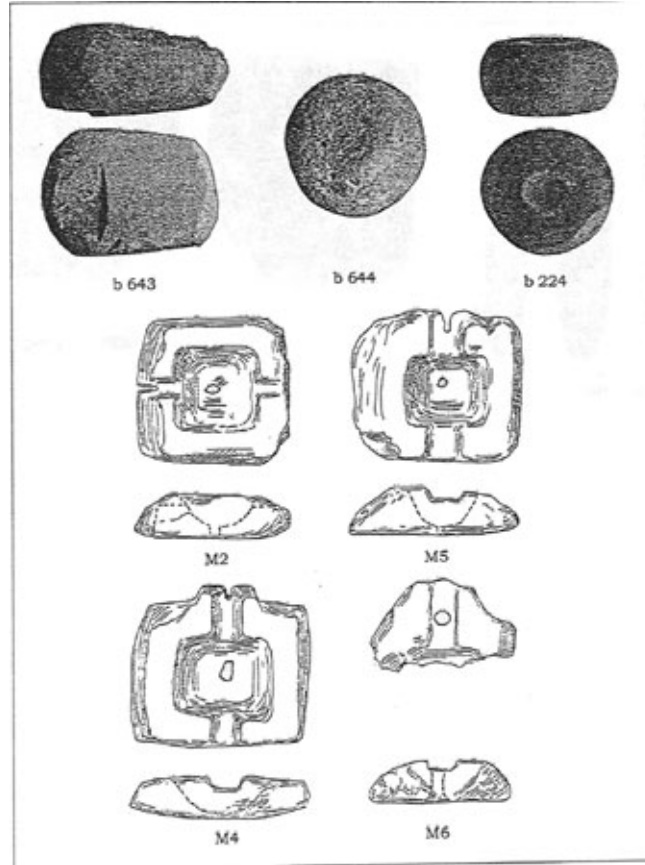

Pl. 514. Objets en pierre : moule, pendentifs, perles, hache, lame en silex, Karahöyük⁴⁸⁵.

⁴⁸⁵ÖZGÜÇ, 1949, Lev. XL.



Pl. 515. Objets en pierre : poids, moules, dés, perles, Alişar⁴⁸⁶.

⁴⁸⁶SCHMIDT, KROGMAN, 1933, fig. 117-120.

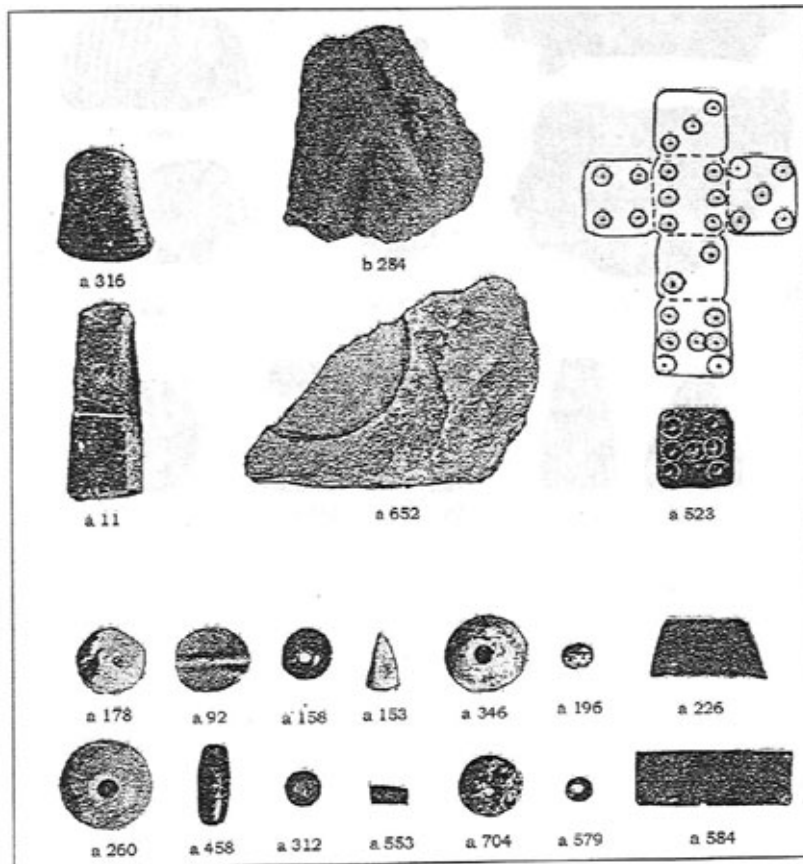

Pl. 516. Objets en métal (b1 en or) et en pierre, Alişar⁴⁸⁷.

⁴⁸⁷SCHMIDT, KROGMAN, 1933, fig. 109-114.



Pl. 517. Carte de répartition des fibules.

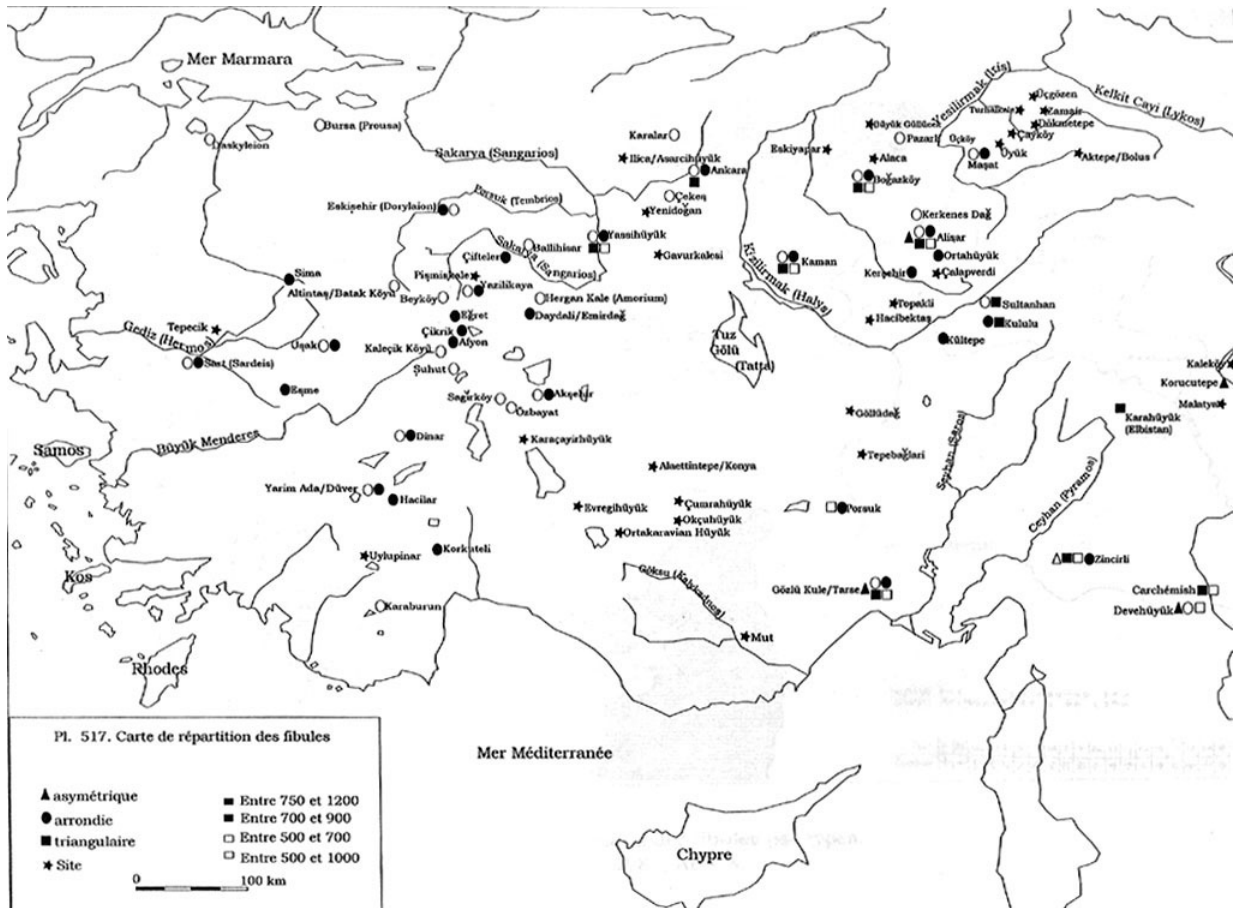

Pl. 518. Carte de répartition des fibules⁴⁸⁸.

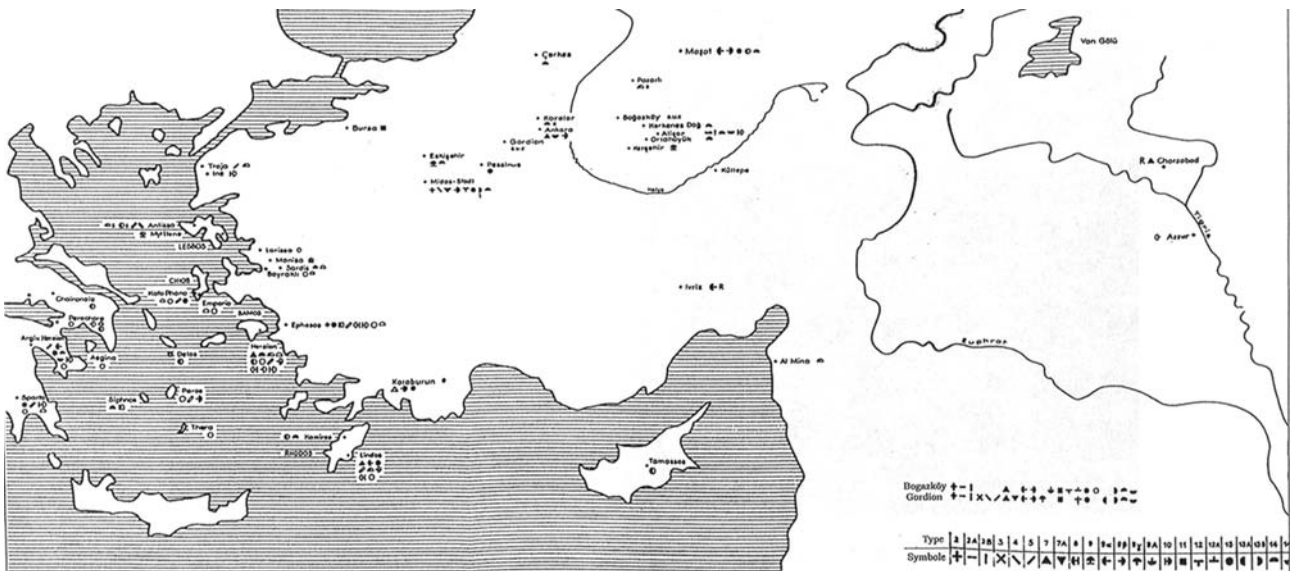

Pl. 519. Tentative de chronologie relative et absolue de la période phrygienne ancienne à Gordion⁴⁸⁹.

⁴⁸⁸BOEHMER, 1983. Abb. 8.

Datation	Céramique	Citadelle	Entrée	Mégarons	Tumuli
+ 1000 av. J.-C.	Non-tournée ancienne Tournée phrygienne	EPB ¹ I ↑ NCT ² IV b ↓			
900		EPB IIa	↑ EPB III	Mégaron 10-4 Mégaron 10-2	
800	Peinte	EPB IIb	↓		
750	Imprimée	EPB IV EPB V EPB VI	(Entrée, nouvelle enceinte) Contexte pré-Mégaron 5		W
725	Motifs incisés	Terrasse ↑ Mégaron 4 ↓ EPB VII	NCT IV a EB-PN ³ 3	Mégaron 10-1	G III P ↑ KY
700		Destruction			X, Y, MM

¹ Early Phrygian Building.

² North-Central Trench

³ Early Bronze Trench-Première tranchée